

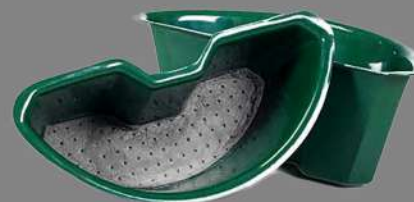

# Hanging Pots and Baskets

self-watering

 **TerraFlor**  
the beauty of pure form





<b>BEST</b>	.....	2
<b>BEST CUP</b>	.....	4
<b>BARIST</b>	.....	6
<b>BARIST BASE</b>	.....	8
<b>CESAR</b>	.....	10
<b>WOVEN</b>	.....	12

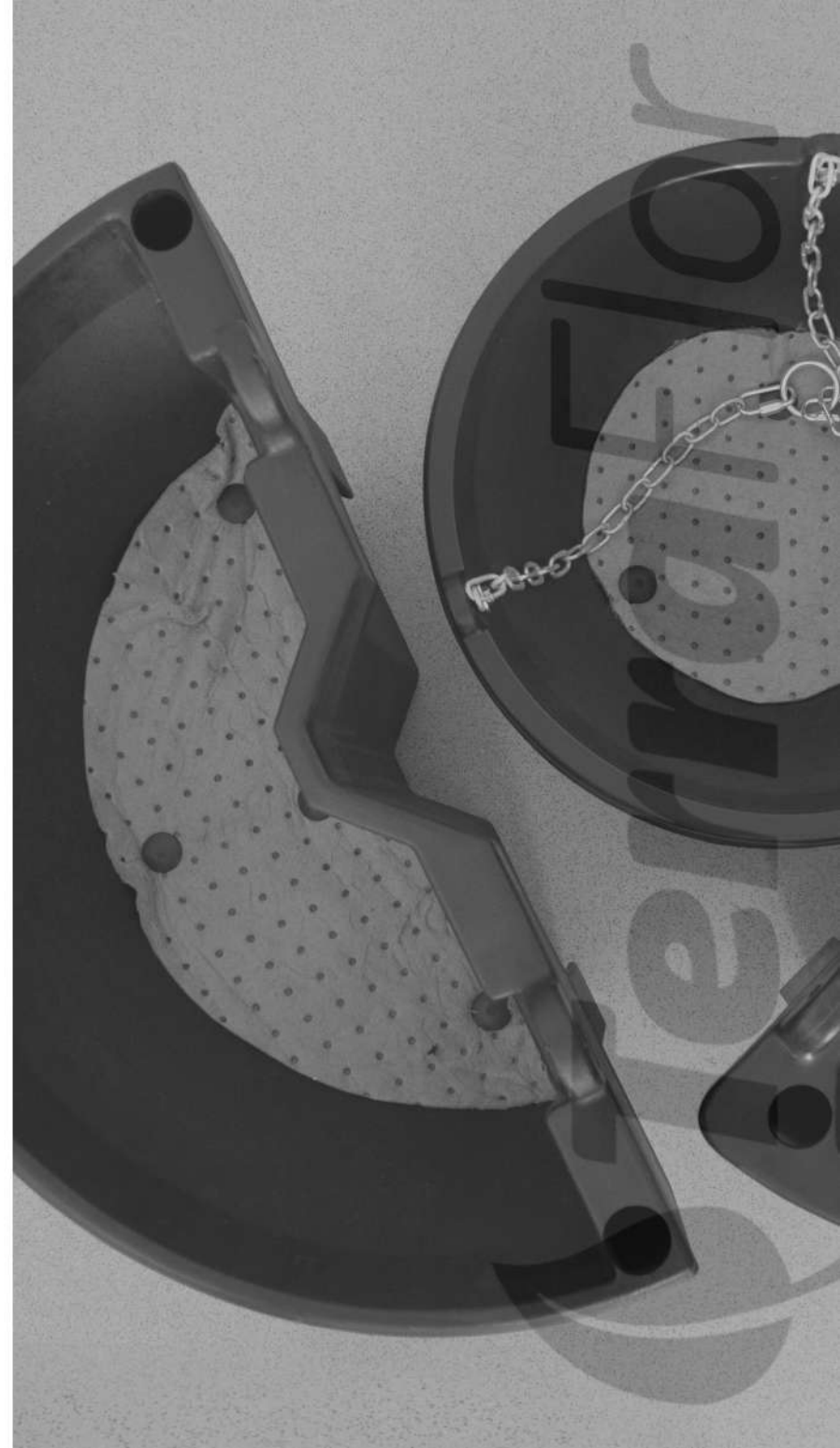



**BEST**



MODEL	CODE	DIMENSIONS[MM]	PRICE
BEST Set (2 halves + fixing ) pot insert x 2 .....	AB UTP-1P	590mm x 270mm	195 euro 90 euro
BEST Set (2 halves + fixing ) pot insert x 2 .....	AB UTP-2P	800mm x 270mm	290 euro 110 euro

black



RAL 9005

dark green



RAL 6032



**Warranty 10 years**

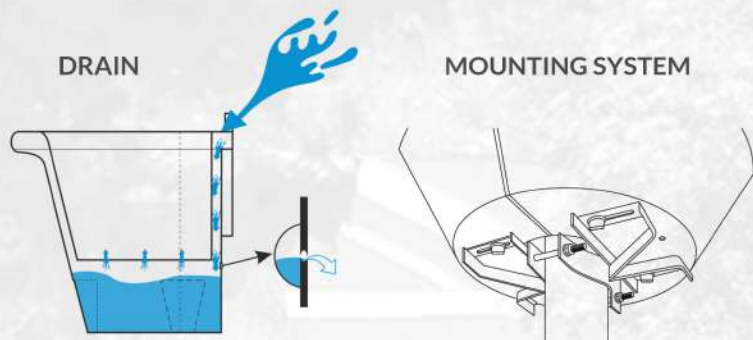

**BEST****TECHNICAL SHEET**

FRONT VIEW

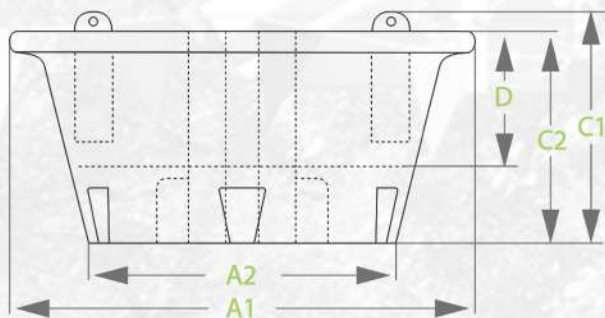

SIDE VIEW

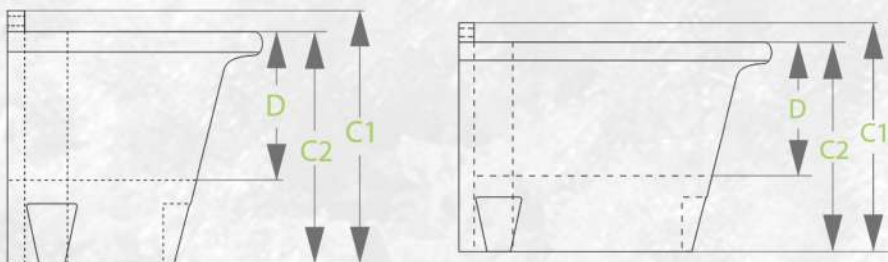
**AB UTP-1P**

A1	level width	<b>590 mm</b>		Capacity of substrate	▶ <b>12 l</b>
A2	bottom width	<b>390 mm</b>		Second bottom capacity	▶ <b>5 l</b>
B	level depth	<b>295 mm</b>		Weight before planting	▶ <b>2,2 kg</b>
C1	total height	<b>295 mm</b>		Weight of the planting	▶ <b>14 kg</b>
C2	height of pot	<b>270 mm</b>		Estimated amount of seedlings	▶ <b>5-7 items</b>
D	insert depth	<b>170 mm</b>		Weight depends on the type of soil and its moisture	
E	diameter of the bottom of the insert	<b>410 mm</b>			

**AB UTP-2P**

A1	level width	<b>800 mm</b>		Capacity of substrate	▶ <b>25 l</b>
A2	bottom width	<b>600 mm</b>		Second bottom capacity	▶ <b>14 l</b>
B	level depth	<b>400 mm</b>		Weight before planting	▶ <b>3,7 kg</b>
C1	total height	<b>295 mm</b>		Weight of the planting	▶ <b>31 kg</b>
C2	height of pot	<b>270 mm</b>		Estimated amount of seedlings	▶ <b>10-12 items</b>
D	insert depth	<b>170 mm</b>		Weight depends on the type of soil and its moisture	
E	diameter of the bottom of the insert	<b>630 mm</b>			

**10 year warranty**





**BEST  
CUP**



MODEL	CODE	DIMENSIONS[MM]	PRICE
BEST CUP ( 2 halves + fixing )	AB CNS-1P	650mm x 300mm	215 euro
pot insert x 2 .....			100 euro

black

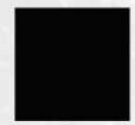

RAL 9005

dark green



RAL 6032



**Warranty 10 years**



**BEST**  
CUP

# TECHNICAL SHEET

**AB CNS-1P**

FRONT VIEW

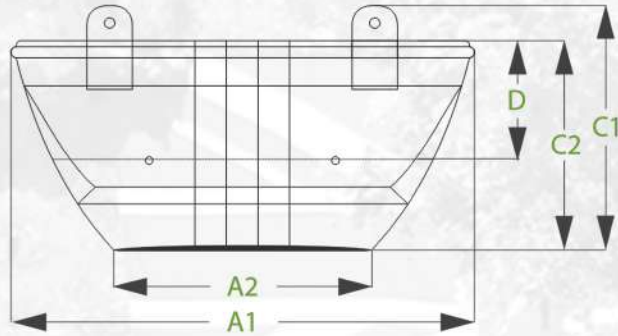

SKETCH

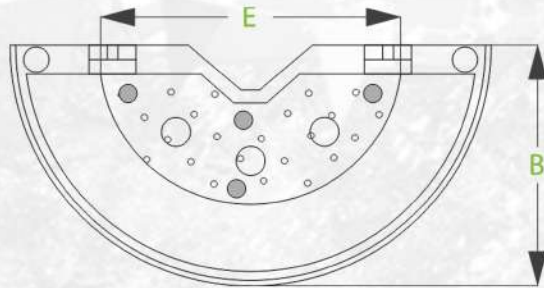

SIDE VIEW

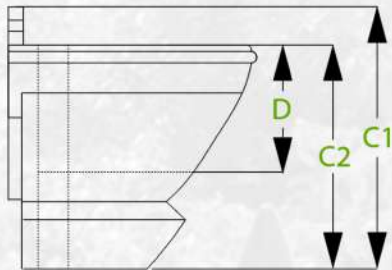

A1	level width	<b>650 mm</b>
A2	bottom width	<b>370 mm</b>
B	level depth	<b>325 mm</b>
C1	total height	<b>350 mm</b>
C2	height of pot	<b>300 mm</b>
D	insert depth	<b>170 mm</b>
E	diameter of the bottom of the insert	<b>430 mm</b>

Capacity of substrate ▶ **12 l**

Second bottom capacity ▶ **9 l**

Weight before planting ▶ **2,7 kg**

Weight of the planting ▶ **18 kg** ?

Estimated amount of seedlings ▶ **5-7 items**

? Weight depends on the type of soil and its moisture

SKETCH

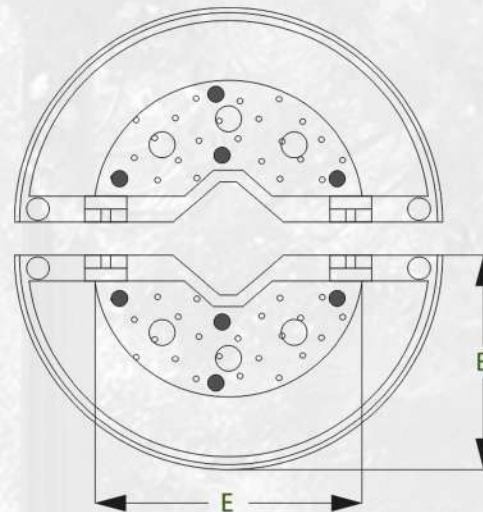

MOUNTING SYSTEM

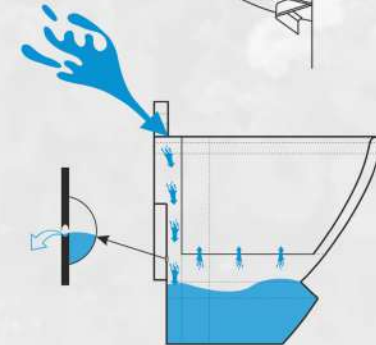
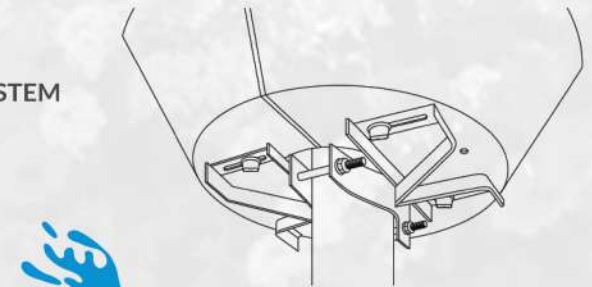

DRAIN

 **10 year warranty**





# BARIST



MODEL	CODE	DIMENSIONS[MM]	PRICE
BARIST with chain	AB CHB-1P	470mm x 270mm	95 euro

black



RAL 9005

dark green



RAL 6032



Warranty 10 years



# BARIST

## AB CHB 1P

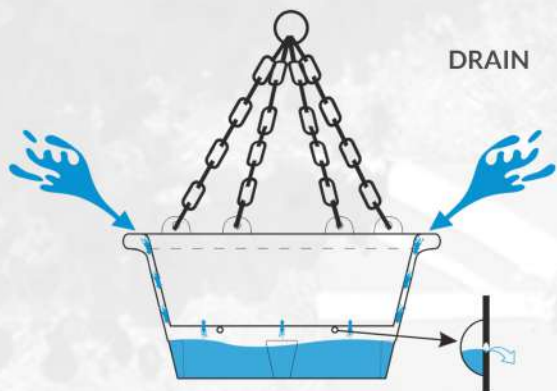

- A diameter of level **470 mm**
- B diameter of bottom **285 mm**
- C total height **270 mm**
- D insert depth **190 mm**
- E diameter of the bottom of the insert **290 mm**

- Capacity of substrate ► **15 l**
- Second bottom capacity ► **6 l**
- Weight before planting ► **2,3 kg**
- Weight of the planting ► **15 kg** ?
- Estimated amount of seedlings ► **10-12 items**

? Weight depends on the type of soil and its moisture

FRONT VIEW



SKETCH

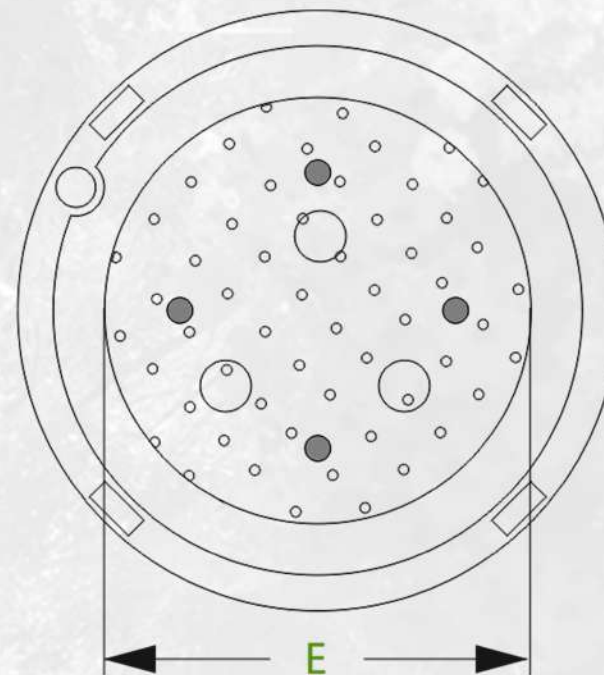

 **10 year warranty**





**BARIST**  
BASE



MODEL	CODE	DIMENSIONS[MM]	PRICE
BARIST BASE with chain	AB CAS-0P	420mm x 240mm	75 euro
BARIST BASE with chain	AB CAS-1P	530mm x 265mm	140 euro

black

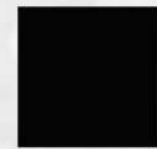

RAL 9005

dark green



RAL 6032



**Warranty 10 years**



# BARIST BASE

## TECHNICAL SHEET

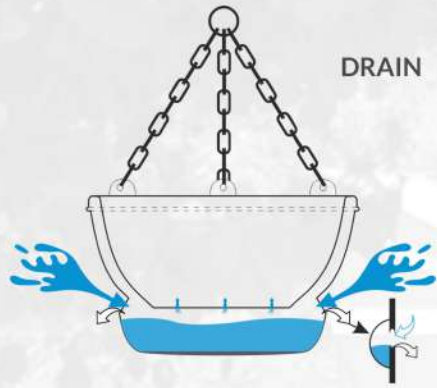

DRAIN

FRONT VIEW



SKETCH

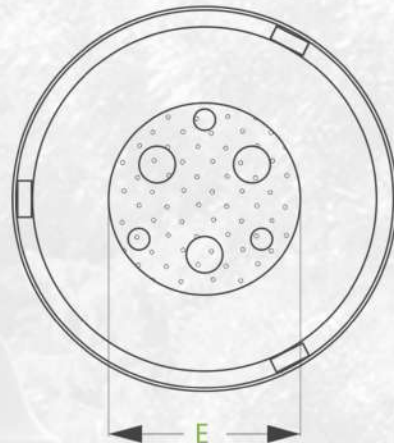

### AB CAS-0P

A diameter of level	<b>420 mm</b>
B diameter of bottom	<b>290 mm</b>
C total height	<b>240 mm</b>
D insert depth	<b>150 mm</b>
E diameter of the bottom of the insert	<b>210 mm</b>

Capacity of substrate	▶ <b>11 l</b>
Second bottom capacity	▶ <b>7 l</b>
Weight before planting	▶ <b>2,3 kg</b>
Weight of the planting	▶ <b>15 kg</b>
Estimated amount of seedlings	▶ <b>8-10 items</b>
Weight depends on the type of soil and its moisture	

### AB CAS-1P

A diameter of level	<b>530 mm</b>
B diameter of bottom	<b>320 mm</b>
C total height	<b>265 mm</b>
D insert depth	<b>190 mm</b>
E diameter of the bottom of the insert	<b>290 mm</b>

Capacity of substrate	▶ <b>24 l</b>
Second bottom capacity	▶ <b>13 l</b>
Weight before planting	▶ <b>3,7 kg</b>
Weight of the planting	▶ <b>27 kg</b>
Estimated amount of seedlings	▶ <b>12-15 items</b>
Weight depends on the type of soil and its moisture	

**10 year warranty**





**CESAR**



MODEL	CODE	DIMENSIONS[MM]	PRICE
CESAR with chain	AB IMP-0P	500mm x 320mm	135 euro

black  
RAL 9005



dark green  
RAL 6032



sandstone



**Warranty 10 years**

T: +48 667 106 666 | E: INFO@TERRA-UK.EU | TERRA-UK.EU





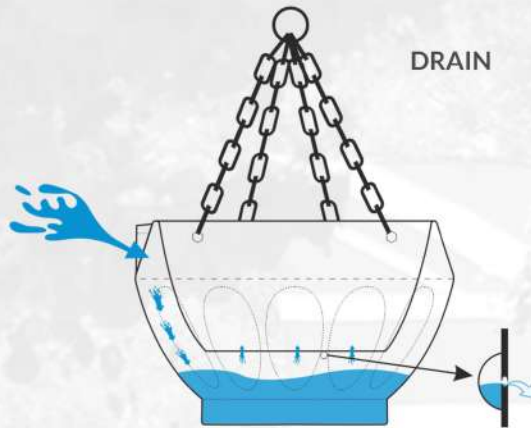

DRAIN

FRONT VIEW

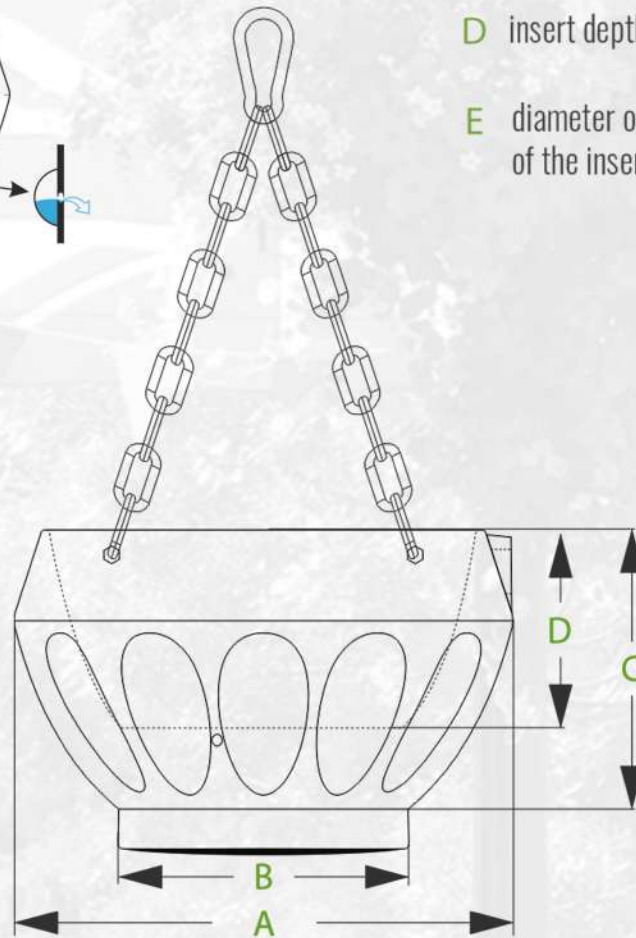

- A diameter of level **500 mm**
- B diameter of bottom **290 mm**
- C total height **320 mm**
- D insert depth **195 mm**
- E diameter of the bottom of the insert **290 mm**

- Capacity of substrate ► **20 l**
- Second bottom capacity ► **8 l**
- Weight before planting ► **4,8 kg**
- Weight of the planting ► **22 kg**
- Estimated amount of seedlings ► **10-12 items**

Weight depends on the type of soil and its moisture

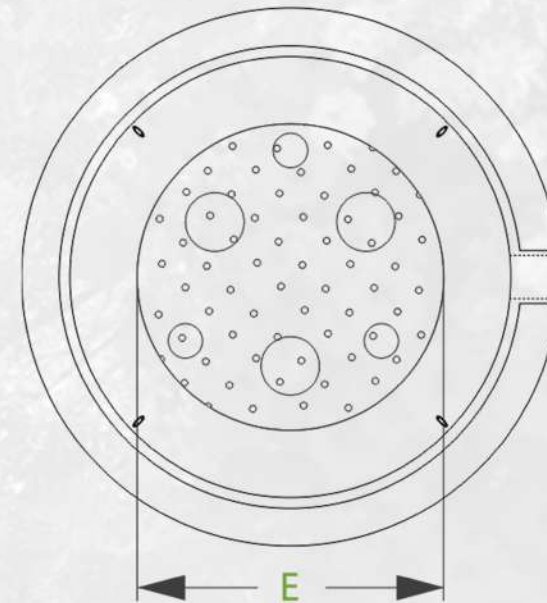

SKETCH





**WOVEN**

MODEL

CODE

DIMENSIONS[MM]

PRICE

WOVEN  
with chain

AB WKR-0P

440mm x 280mm

80 euro



**Warranty 10 years**

black

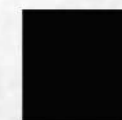

RAL 9005

dark green



RAL 6032







*Terra Group*

*create more  
beautiful tomorrow!*

ul. Gen. Józefa Sowińskiego 42a  
65-419 Zielona Góra

T: +48 68 413 92 02  
F.: +48 68 414 54 25

E: [info@terra-uk.eu](mailto:info@terra-uk.eu)  
[www.terra-uk.eu](http://www.terra-uk.eu)