

Kaskadenkonstruktionen
Kaskadenkonstruktionen / Flower Towers



Dort, wo die Natur nicht reicht...
Where nature doesn't reach...



Model H700	10-17	Model H2400	76-83
Model H750	18-25	Model H3000	84-91
Model H1100	26-33	Model H3400	92-99
Model H1150/750	34-41	NEW Cultur Tub	102-105
Model H1200	42-51	Model W600/1/2/3	106-121
Model H1200 $\frac{1}{2}$ $\frac{1}{4}$ $\frac{1}{2}$ <small>ROUND</small>	52-63	NEW Model W800/1	122-127
Model H2000	64-71	NEW Model W600/2/3 $\frac{1}{2}$	128-133
Model H2000 $\frac{1}{2}$	72-73		

Dort wo die Natur nicht reicht... | www.blumentuerme.de

Where nature doesn't reach... | www.terra-flower-tower.com

45 000

products sold worldwide

über **25 YEARS**
of experience

in the creation of urban space

Die höchste Priorität für die Firma Terra hat die Versorgung der Kunden mit innovativen und effektiven technologischen Lösungen für das Wachstum der Pflanzen. Dank der Verbindung des Wissens von Produktionsexperten, Designern und Landschaftsarchitekten sind Terra-Produkte immer innovative Lösungen von höchster Qualität.

The priority of Terra is designing and production of innovative and effective technological solutions in plant growing. Thanks to the integration of the knowledge of technologists, designers and landscape architects, the products of Terra are always inventive tools with high quality.



we are the LEADER

in the production of innovative tools
for urban space shaping

Produkte der Firma Terra finden Sie in Städten, Dörfern, Parks, Wohnvierteln, Einkaufszentren, Bahnhöfen, Hotels usw. Diese innovativen Produkten werden in ganz Europa und sogar weltweit verwendet. Sie tragen zur Verschönerung vieler Städte bei und verleihen ihnen einen einmaligen Charakter. Sie bringen Farben in solche Städte wie Berlin, Casablanca, Wien, Riga, Wrocław oder Poznań...

You'll find the products of Terra in urban and rural spaces, parks, shopping centres, bus and train stations, hotels etc. These inventive products are used in the whole Europe and in the world. They contribute to decorate such famous places as Krakowskie Przedmieście in Warsaw and Piotrkowska Street in Łódź. They also bring colours to the biggest cities like Berlin, Casablanca, Vienna, Riga, Wrocław and Poznań...



Ich erinnere mich genau an dieses Jahr...

- 1994** Mitte der 90er Jahre begann ich mein Abenteuer mit meinem eigenen Unternehmen. Wer könnte vermuten, dass Hydrogel, welches im Mittelpunkt meiner damaligen beruflichen Interessen stand, nur eine der Erfolgssäulen der Fa. Terra Group wird? Das sollte erst in der Zukunft geklärt werden, aber schon damals begleiteten mich die Ambitionen und der Wunsch, die Landschaft Polens zu verändern.
- 1998** In Disneyland zog eine schöne Ansicht meine Aufmerksamkeit: ein Platz wurde mit hohen Blumenpyramiden verschönert. Diese Landschaft, die sich so stark von der polnischen Eintönigkeit der 90er Jahre unterschied, blieb mir in Gedächtnis haften. So entstand eine Idee... Genau das fehlt in Polen! Dieser Gedanke schwebte mir die ganze Rückreise lang vor. Ich bat meinen Vater-Ingenieur um Hilfe. In einer kleinen, am Haus gelegenen Werkstatt begannen wir enthusiastisch die Arbeit...
- 1999** Die Versuch-Irrtum-Etappe schien ewig zu dauern. Prototypen sahen nicht so gut aus. Nach vielen Versuchen gelang es uns, die erste Kaskadenkonstruktion zu schaffen. Das erste Modell H2400 habe ich mit meinem Vater bepflanzt. Das war etwas Ungewöhnliches!
- 2000** In neues Jahrtausend trat ich mit Hoffnung und Optimismus ein. Ich begann, unsere Pläne zu bewerben. Endlich kam diese Zeit – für unsere Produkte hat sich die Stadtverwaltung in Wrocław und Duszniki-Zdrój entschieden.
- 2002** Im Laufe der Zeit ergab es sich, dass zwei Modelle nicht ausreichend sind. Jeder Kunde hat doch andere Bedürfnisse. Ich führte tausende Gespräche... ich vervollkommnete bestehende Produkte und führte in das Angebot neue Modelle (H750 und H1100) ein.
- 2004** 101... ich mag seit immer die Zahlen. Diese Zahl war für mich besonders wichtig. Im Juni haben wir die Grenze der 100 verkauften Produkte überschritten!
- 2007** Vor drei Jahren trat Polen der Europäischen Union bei, was neue Möglichkeiten eröffnete. In diesem Jahr wurde die erste Bestellung in Deutschland realisiert.
- 2008** 2008 - 1001... wenn ich durch Polen reise, sehe ich immer häufiger unsere Produkte. Vor kurzem träumte ich nur von Veränderungen, jetzt kann ich sie beobachten. Wir haben 1001 Produkte verkauft. Das ist 1001 positive Änderungen! Unsere Kaskadenkonstruktionen wurden u.a. auf internationaler Messe in Posen ausgezeichnet.
- 2009** Wir haben ein Familienunternehmen geschaffen. Die Verbindung der Jugend mit der Erfahrung bedeutete den Anfang der Änderungen...
- 2010** Ich konzentrierte mich auf Team-Bildung. Firma wird doch von Menschen geschaffen – in Menschen liegt also die Kraft. Wir müssten nicht lange auf Effekte warten. Unsere Produkte kann man auf der ganzen Welt finden – u.a. in Casablanca. Gleichzeitig arbeiten wir an neuen Produkten. Wir führten hängende Kaskadenkonstruktion W600 ein. Sie wurde auf 150 Straßenlaternen in Lodz montiert.

I perfectly remember this year...

- 1994** In the mid-90s, I started my adventure with entrepreneurship. Could anyone expect that the hydrogel, which was the center of my professional interests at that time, was only one of the many pillars of Terra Group's success? Only the passing time was to decide about this, but the ambitions and desire to change the landscape of Poland were with me already then.
- 1998** It was then that I was intrigued by a beautiful view in Disneyland Paris – a square decorated with high pyramids planted with flowers. I still remember this picture, so different from Polish greyness of the 90s. And a certain idea came to my mind... This was it what Poland needed! This thought accompanied me all the way home. I asked my father, an engineer, for help. Equipped with enthusiasm and the vision of urban space change, we started working in a small backyard workshop...
- 1999** The stage of trial and error lasted endlessly. Although the prototypes didn't look impressive, we managed to create the Flower Tower. We planted the very first H2400 model with flowers. That was something!
- 2000** I stepped in the new millennium full of optimism and hope. I began promoting our vision of the change of Polish cities. Finally, the day has come – municipal authorities of Wrocław and Duszniki-Zdrój decided to use our products.
- 2002** With time it turned out that two models weren't enough – each client had their own needs. I talked and listened... Based on those conclusions, I improved existing models and introduced two new models, H750 and H1100, to the offer.
- 2004** 101... I've always been keen on numbers, and this one was special for me. In June 2004 our two-person team crossed the ceiling of 100 sold products.
- 2007** The entry to the European Union opened new possibilities. This year we implemented the first project in Germany.
- 2008** 1001... When I travelled through Poland, I passed by more and more of our products. Not so long ago I had dreamt about beautiful urban space, and then, I was the witness of this transformation. We had sold 1001 products. These were 1001 good changes... Evidence? Our Flower Towers got two awards on international exhibitions.
- 2009** Our family bonds became foundations for creating a family company. The clash of youth with experience was the beginning of a new change...
- 2010** I focused on team building. People create a company, and people are the strength. We didn't have to wait too long for effects. Our products began reaching to the farthest corners of the world. We won the contract in Casablanca in Morocco. All this time we're working on new products – the result was the new W600 model designed for street lamps. Simultaneously, we carry out the project of the modernisation of Piotrkowska Street in Łódź in Poland where 150 lamps were decorated with W600. That year we also offered a new Full Service – selling constructions with blooming flowers, ready to decorate the city.



Jahrelang beobachtete ich Deine Arbeit...

- 2011** In Zielona Góra entsteht die Filiale – das kreative Herz der Firma. In der Marketingabteilung arbeiten kreative Menschen voller neuen Ideen. Wir eröffnen auch die Filiale in Deutschland.
- 2012** Ständige Entwicklung ist für uns sehr wichtig, so wird unsere Produktpalette immer breiter. In diesem Jahr bieten wir unseren Kunden auch das Modell H700 an.
- 2014** 5001... über 70% polnische Städte hat sich schon für unsere Lösungen entschieden. Kaskadenkonstruktionen wurden zum festen Element unserer Landschaft. Ich bin stolz auf Menschen, die zusammen mit mir diesen Erfolg verdienen!
- 2016** Terra ist jetzt eine der vielen Marken, die Terra Group schaffen. Wir beschäftigen über 30 Mitarbeiter und liefern unsere Produkte nach über 500 Städten in Polen, Europa und auf der ganzen Welt. Was wichtig, handeln wir nach den Regeln, die mein Großvater und mein Vater am Anfang bestimmt haben. Empfindlichkeit, Teamarbeit und Loyalität. Wir sind doch Familie...
- 2017** Das ist aber erst der Anfang von Änderungen... Die Fa. Terra Group ist ein führendes Unternehmen seiner Branche mit einem ausgezeichneten Blick in die Zukunft. Ich bin stolz darauf, dass wir dieses Ziel mit unserer harten Arbeit erreicht haben. Terra ist jetzt eine der vielen Marken, die Terra Group schaffen. Wir beschäftigen über 30 Mitarbeiter und liefern unsere Produkte nach über 500 Städten in Polen, Europa und auf der ganzen Welt.
- 2018** Seit der Gründung des Unternehmens ist mehr als ein Vierteljahrhundert vergangen. In dieser Zeit hat sich die Fa. Terra Group unglaublich entwickelt. Es entstanden auch neue Produkte und frische Ideen, die von unseren Kunden inspiriert wurden. Nur im Jahr 2018 bauten wir zwei Marken auf: die Kollektion der Stadtmöbel TerraCity und der Osterdekorationen TerraEaster. Mit Optimismus denken wir an die nächsten Jahre!
- 2019** Unglaublich! Die Geschichte der Fa. Terra Group begann vor 25 Jahren... Im Jahr 2019 feiern wir gemeinsam mit unseren Kunden, Auftragnehmern, Partnern und Mitarbeitern ein Jubiläum - ohne Sie wäre das letzte Vierteljahrhundert nicht so erfolgreich gewesen. Vielen Dank! Schon jetzt warten wir ungeduldig auf die nächsten, ebenso beeindruckenden Jubiläen!
- 2020** Yama heart, yama soul
...das Jahr 2020 beginnen wir mit einem Lied auf den Lippen. Wir lieben Änderungen und eine ständige Entwicklung ist für uns sehr wichtig – wir summen eine bekannte Melodie eines deutschen Duos, packen unseren Schreibtisch und beginnen die Reise nach... Yama. So heißt der neue Hauptsitz von Terra Group. Aber manche Dinge ändern sich nie - Kaffee trinken wir immer in guter Gesellschaft und unser Hunger nach Erfolg ist ebenso groß!

I've been observing you for years...

- 2011** Dynamic and original – such people created the branch of Terra in Zielona Góra, Poland. This is the place where we located a creative heart of our company – the marketing department. In this time we also decided to open an office in Germany.
- 2012** We focused on the development so our product collection was still growing – we welcomed H700 and „the halves“ on board!
- 2014** 5001... more than 70% of Polish cities benefited from our solutions. Flower Towers etched into the landscape of our country permanently. I was proud of people who earned this success together with me!
- 2016** Nowadays Terra is one of the brands creating Terra Group. Currently we hire over 30 people and we deliver products up to 500 places in Poland, Europe and in the world. It's crucial that we still work in accordance with the principles that guided my father and grandfather at the beginning of this company – sensitivity to the needs of others, team work, and most of all, a sense of unity and loyalty. After all, we're family...
- 2017** Changes, changes ... Terra Group is a leading company in its industry with excellent prospects. I am proud that we have reached this level with our joint hard work. Currently, Terra is one of the many brands that make up Terra Group. We currently employ over 30 people and deliver products to over 500 places in Poland, Europe and the world.
- 2018** More than a quarter of a century has passed since the foundation of the company. During this time, Terra Group has undergone a major metamorphosis - new products and proposals inspired by our clients were created. Only in 2018, we developed two brands: the street furniture collection TerraCity and TerraEaster - Easter decorations. We think about the next years with a smile!
- 2019** Amazing! It's been 25 years since we started to tell the story of Terra Group. In 2019, together with our clients, contractors, partners and employees, we are celebrating a solemn jubilee - without You the past quarter of a century would not be so successful. Thank you and we are already looking forward to the next, equally impressive anniversaries!
- 2020** We entered 2020 with flying colors. We do not like standing still, so we focus on constant changes - while humming some optimistic melodies, we packed our desk and set off on a trip to Yama. This is what the new headquarters of Terra Group is called. However, some things do not change - morning coffee always in good company, and the hunger for success is equally high.

Bogusław Albinowski
CEO Terra Group

Wussten Sie, dass...

► BEWÄSSERUNGSSYSTEM

TERRA CLICK TIF ist ein integriertes, an Kaskaden-Blumenständerkonstruktionen Terra speziell angepasstes System. Es garantiert eine hohe Präzision bei der Bewässerung, reduziert sowohl die Kosten (dank der Anpassung der Wassermenge an die Pflanzenbedürfnisse) als auch den Zeitaufwand, der mit der Pflege verbunden ist.

► KEINE SCHARFEN KANTEN

Bei der Gestaltung von Kaskaden-Blumenständerkonstruktionen Terra wurden alle Elemente, die in irgendeiner Weise der Sicherheit ihrer Benutzer gefährden könnten, eliminiert. Zusätzlich sind die Ringkanten mit Gummidichtung ausgestattet. Gleichzeitig schützen sie die Pflanzen vor den mechanischen Beschädigungen.

► LASERGESCHNITTENE RINGE

Der Laserschnitt, der bei der Ringherstellung angewendet wurde, ist die modernste Methode der Metallbearbeitung. Dank dieser Technologie zeichnen sich unsere Produkte durch höchste Qualität aus.

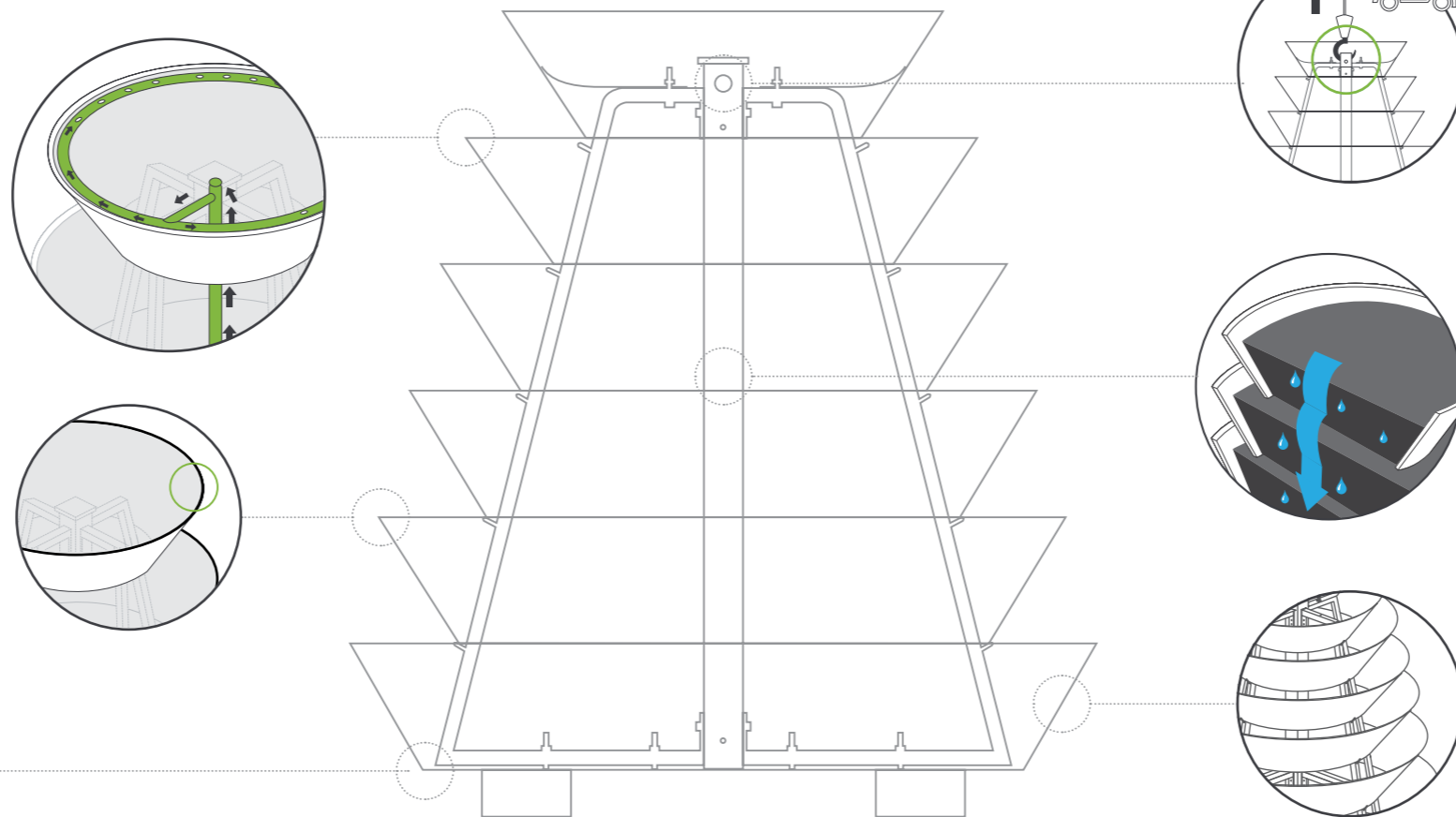

► TRANSPORTMODUL

Funktionales System, das bequeme Entladung der bepflannten Konstruktionen erleichtert und lässt das Risiko der Blumenbeschädigung reduzieren. Der sichere und widerstandsfähige Griff beschleunigt wesentlich den Prozess der Einführung von Produkten in gewählten Raum.

► KASKADENSYSTEM

Innovative und mit Patent geschützte Lösung, die Effektivität und Qualität des Pflanzenanbaus wesentlich erhöht. Da die einzelnen Schichten der Blumenständerkonstruktion keinen Boden besitzen, haben die Pflanzenwurzeln optimale Wachstumsbedingungen sowie entsprechende Wasser- und Luftmenge.

► DIEBSTAHSICHERUNG

Sichere und dauerhafte Lösung, die unsere Produkte vor Diebstahl schützt. Dank der stabilen und widerstandsfähigen Bodenbefestigung bleibt die Kaskaden-Blumenständerkonstruktion an ihrem Bestimmungsort.

Do you know that...

▶ WATERING SYSTEM

TERRA CLICK TIF watering installation is an integrated system specially designed for Terra Flower Towers. It provides a high precision of watering, reduces time required for maintenance and saves money thanks to adjusting watering to plant needs.

▶ NO SHARP EDGES

The design of Flower Towers eliminates elements that could be dangerous in use in any possible way. Additionally, the edges of rings are finished with rubber gaskets that also protects plants from mechanical damage.

▶ LASER-CUT RINGS

Laser cutting used in production is the most modern method of metal processing. Thanks to this technology, offered products are characterised by the highest quality of workmanship.

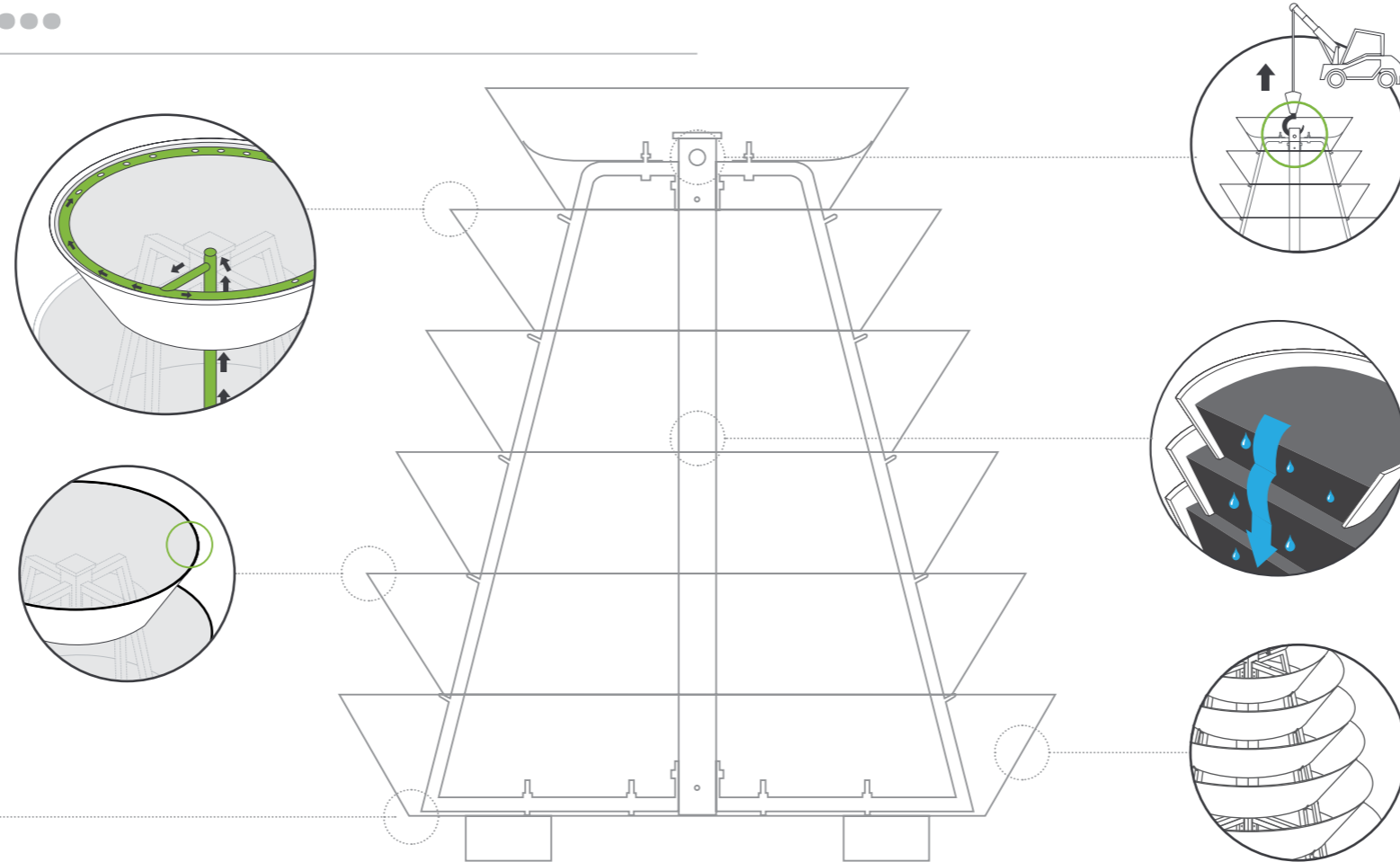

▶ TRANSPORT MODULE

A functional system that make unloading easier and without a risk of plant damage. A safe and durable handle accelerates the process of providing products into urban space

▶ CASCADE SYSTEM

The innovative and licensed solution that increases the effectiveness and quality of plants. Particular ring layers of a flower tower haven't got bottoms, so roots have ideal grow conditions and optimal amount of water and air.

▶ LASER-CUT SYSTEM

The safe and solid solution that eliminates losses caused by robbery. Stable and durable installation to the ground makes constructions immovable.

ÄSTHETISCH UND SICHER
AESTHETIC AND SAFE

www.blumentuerme.de

www.terra-flower-tower.com



KASKADENKONSTRUKTION FLOWER TOWER

H 700

Die Vorteile dieses kleinen Modells liegen in seiner schlanken Silhouette und großem Fassungsvermögen. In diesem Blumenturm können ungefähr 40 Blumensetzlingen angepflanzt werden. Dank seiner Form einer blumigen Kugel lässt er ein bisschen Farbe in jede Umgebung einführen.

It surprises you with a slim shape and a huge capacity. This smallest model is able to contain about 40 plants. The floral form of a sphere, into which a construction transforms after planting, will add colours to the city and brightens up the area.

☰ 3 levels



105 - 160 kg



167 l



720 mm

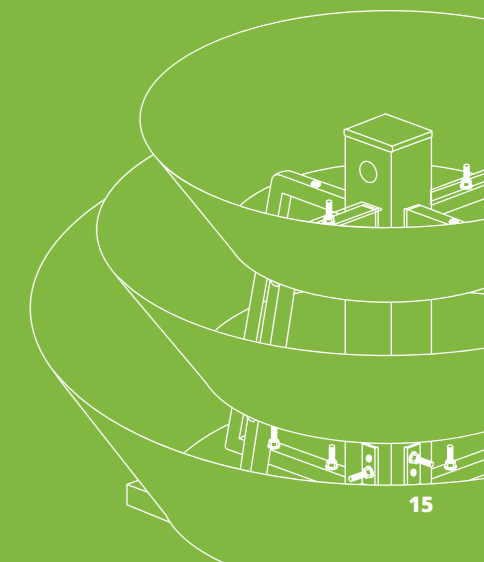





STRASSENGRÜN

Verwandeln Sie die Straße in einen farbenfrohen und freundlichen Ort! Die Kaskadenkonstruktionen H700 bewähren sich perfekt an schwer zugänglichen Stellen, sie begrenzen auch keine Sicht beim Autofahren.

STREET GREENERY

Transform the street into a colorful and resident-friendly place in an easy way. H700 Flower Towers work well in locations that are difficult to reach for greenery, and most importantly, they do not limit the visibility of drivers.

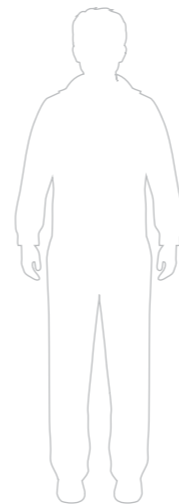

H 700



straße
street



gehweg
pavement



marktplatz
town square



kreisverkehr
roundabout



denkmal
monumen

	Anzahl der Ringe levels	▶	3
	Fassungsvermögen capacity	▶	167 l
	Gesamthöhe total height	▶	720 mm
	Basisdurchmesser bottom diameter	▶	750 mm
	Gewicht vor Bepflanzung weight before planting	▶	35 kg
	Gewicht nach Bepflanzung weight after planting	▶	105 - 160 kg
	Anzahl der Setzlinge estimated number of plants	▶	30 - 40
	Basisfarbe basic colour	▶	5
	Farbvarianten available colours	▶	1 2 3 4

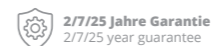

2/7/25 Jahre Garantie
2/7/25 year guarantee



Transportmodul
transport module



Bewässerungssystem
watering system



Mobilsystem
mobile system



► KEINE SCHARFEN KANTEN NO SHARP EDGES

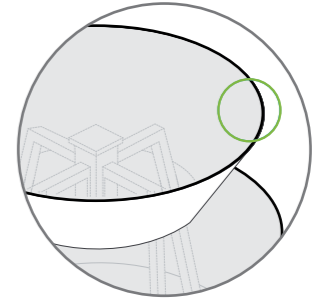

Bei der Gestaltung von Kaskaden-Blumenständerkonstruktionen Terra wurden alle Elemente, die in irgendeiner Weise der Sicherheit ihrer Benutzer gefährden könnten, eliminiert. Zusätzlich sind die Ringkanten mit Gummidichtung ausgestattet. Gleichzeitig schützen sie die Pflanzen vor den mechanischen Beschädigungen.

During designing Flower Tower, we put emphasis on their safe use. Decorations haven't got any sharp fragments or any other elements that could cause danger. The edges of particular rings are finished with rubber gaskets that also minimize the risk of injury and damage to plants.

“Quality and safety cannot be copied

Der größte Vorteil unserer Produkte liegt in ihrer Qualität. Wir beachten auch die Regeln der Sicherheit, Funktionalität und Ästhetik. Präzise Ausführung und Anwendung der hochwertigen Materialien garantieren problemlose, jahrelange Nutzung der Kaskadenkonstruktionen.

Quality is one of the most valuable features of our products. We maintain it on the highest level, caring about safety, functionality and aesthetics at the same time. The precise workmanship and the best materials guarantee trouble-free and safe use of a construction for years

Weronika Filipek

Key Account Specialist | +49 30 12 07 46 90 | weronika.filipek@terra-de.eu



KLEINE KONSTRUKTION, GROSSE MÖGLICHKEITEN
SMALL BUT WITH BIG POSSIBILITIES

www.blumentuerme.de

www.terra-flower-tower.com



KASKADENKONSTRUKTION
FLOWER TOWER

H 750

Niedrige und zugleich ausladende Form der Konstruktion lässt einen einzigartigen Effekt des Blumenhügels erzielen. Dank seiner Höhe passt sich dieses Modell hervorragend an die Mittelfläche von Kreisverkehren, Kreuzungen und Grünanlagen an. Es ist ein ideales Werkzeug zur wirksamen und schnellen Dekoration von Orten, wo traditionelle Bepflanzung unmöglich ist..

This short and branchy construction gives an unusual effect of a mound. Due to its build, it's a suitable decoration for roundabouts, junctions or squares. H750 model is also a perfect tool for effective and fast arrangement of urban space lacking natural ground.

☰ 3 levels



190 - 370 kg



373 l



740 mm







DENKMAL

Denkmäler spielen eine wichtige Rolle im Stadtraum – sie funktionieren als Gedenkstätten, machen wichtige Ereignisse oder Persönlichkeiten unvergesslich. Aus diesem Grund sollten sie ungewöhnlich dekoriert werden. Betonen Sie ihre Bedeutung mit Kaskadenkonstruktionen.

MONUMENT

Monuments are significant elements in urban space. Such places commemorate crucial events and people that are important to the society and the country, so they need to be representative. Underline their value and accentuate them with the help of Flower Towers.

H 750



straße
street





marktplatz
town square



kreisverkehr
roundabout



denkmal
monumen

	Anzahl der Ringe levels	▶	3
	Fassungsvermögen capacity	▶	373 l
	Gesamthöhe total height	▶	740 mm
	Basisdurchmesser bottom diameter	▶	1200 mm
	Gewicht vor Bepflanzung weight before planting	▶	58 kg
	Gewicht nach Bepflanzung weight after planting	▶	190 - 370 kg
	Anzahl der Setzlinge estimated number of plants	▶	40 - 50
	Basisfarbe basic colour	▶	 5
	Farbvarianten available colours	▶	 1  2  3  4

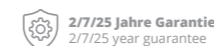
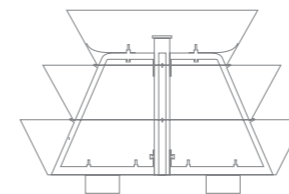
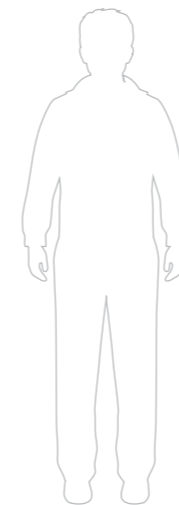

27/25 Jahre Garantie
27/25 year guarantee



Transportmodul
transport module



Bewässerungssystem
watering system



Diebstahlsicherung
anti-theft system



Mobilsystem
mobile system



► LASERGESCHNITTENE RINGE LASER-CUT RINGS

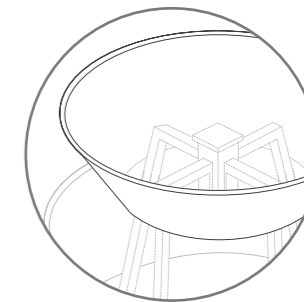

Der Laserschnitt, der bei der Ringherstellung angewendet wurde, ist die modernste Methode der Metallbearbeitung. Dank dieser Technologie zeichnen sich unsere Produkte durch höchste Qualität aus.

Laser cutting of steel that is applied in the production of Flower Towers is the most modern and effective method of metalworking. The application of this technology guarantees that the rings are perfectly even and without any flaws. The constructions are characterised by the highest quality of workmanship and smooth edges.

“ See before deciding! ”

Möchten Sie das Arrangement Ihres Raumes sorgfältig planen? Sind Sie gespannt, wie sich Ihre Stadt nach der Einführung der Kaskadenkonstruktionen präsentieren wird? In wenigen Augenblicken schaffen wir eine kostenlose, an Ihre Bedürfnisse angepasste Visualisierung. Kontaktieren Sie uns per visualisation@terraflowertower.eu und schauen Sie sich an, wie wir zusammen Ihren Raum verändern können.

Do you want to plan the appearance of urban space? Do you wonder how your city will look with Flower Towers? We can create a free visualisation adjusted to your needs. Write to us on wizualizacje@terra-pl.eu and see how we can change public space together.

Katarzyna Bąba

Key Account Specialist | +48 68 455 62 69 | katarzyna.baba@terra-uk.eu



UNIVERSALITÄT ZÄHLT
UNIVERSALITY MATTERS

www.blumentuerme.de

www.terra-flower-tower.com



KASKADENKONSTRUKTION FLOWER TOWER

H 1100

Diese schlanke Kaskade ist als einzige schon in der Basisversion pulverfarbbeschichtet. Sie ist mobil und montagefreundlich. Sie lässt einen großen Effekt in kleinen Räumen wie z. B. Gehwege erreichen. Dieses Modell präsentiert sich am besten in Begleitung anderer Blumentürme.

A slim cascade, which as the only one, is powder coated in basic version. This model is movable and easy to install. It makes a huge impression in narrow places such as pavement or avenue. Its aesthetic qualities are the most seen when you put several constructions next to one another.

☰ 6 levels

⚖ 90 - 120 kg

💧 125 l

⚡ 1010 mm

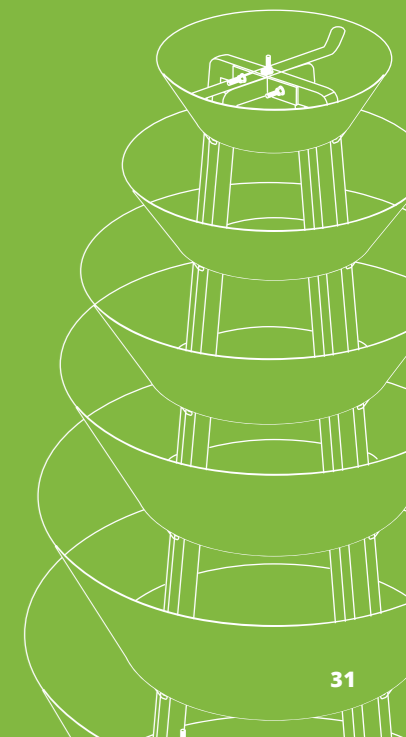



BOHATERSKIM DZIECIOM WRZEŃNINIM
BRONIĄCYM MOWY POLSKIEJ
W STRAJKU SZKOLNYM
1901-1902

SPÓŁKOWOŚĆ
MIASTA I POWIATU
WRZEŃNINIE
W ROKU
1995

WIELKA-ŚWIĘTOJA
DZIECI POLSKI 1940-1945
MIASTO-ŚWIĘTOJA 1945

CENTRUM
GRODMICZE

WC

KWAZC

1700

9.00 - 20.00
10.00 - 14.00



REPRÄSENTATIVER PLATZ

Die wichtigsten Orte in der Stadt brauchen eine besondere Dekoration - nichts bewährt sich so gut wie saisonale Blumen. Pflanzen in Blumentürmen können zusammen mit den Jahreszeiten gewechselt werden, so dass sich die Plätze immer am schönsten präsentieren.

THE REPRESENTATIVE SQUARE

The most important places in the city require special decorations - nothing works as well as seasonal flowers. The plants in the Flower Towers can be changed according to the rhythm of nature so that squares always look as good as possible.

H 1100



gehweg
pavement



markplatz
town square





park
park

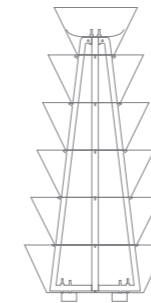
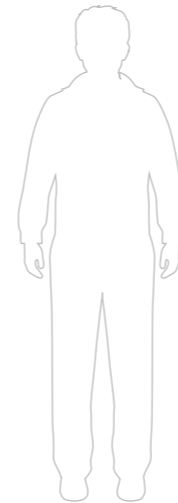

denkmal
monumen

	Anzahl der Ringe levels	▶	6
	Fassungsvermögen capacity	▶	125 l
	Gesamthöhe total height	▶	1010 mm
	Basisdurchmesser bottom diameter	▶	600 mm
	Gewicht vor Bepflanzung weight before planting	▶	30 kg
	Gewicht nach Bepflanzung weight after planting	▶	90 - 120 kg
	Anzahl der Setzlinge estimated number of plants	▶	32 - 50
	Basisfarbe basic colour	▶	 4
	Farbvarianten available colours	▶	 1  2  3



 2/7/25 Jahre Garantie
2/7/25 year guarantee

 Bewässerungssystem
watering system

 Mobilsystem
mobile system





► BEWÄSSERUNGSSYSTEM WATERING SYSTEM

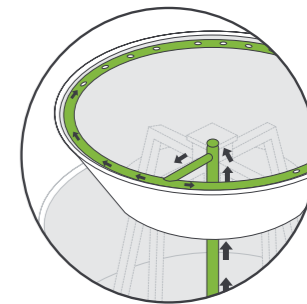

TERRA CLICK TIF ist ein integriertes, an Kaskaden Blumenständer-konstruktionen Terra speziell angepasstes System. Es garantiert eine hohe Präzision bei der Bewässerung, reduziert sowohl die Kosten (dank der Anpassung der Wassermenge an die Pflanzenbedürfnisse) als auch den Zeitaufwand, der mit der Pflege verbunden ist.

TERRA CLICK TIF watering installation is an integrated system specially designed for Terra Flower Towers. It provides a high precision of watering, reduces time required for maintenance and saves money thanks to adjusting watering to plant needs.

Go green!

Seit fast 2 Jahren unterstützt der Weblog greenspired.de die Städte, die bunte, natürliche Akzente in Ihre Räume einführen. Jedes Jahr organisieren wir den Wettbewerb Terra Flower Power – Die am schönsten bepflanzte Stadt in Polen. Suchen Sie nach Ideen, wie man das Image Ihrer Stadt verbessern kann? Lassen Sie sich unter www.greenspired.de inspirieren!

We notice the advantages of urban greenery when we miss it... This is why we've supported on our blog "Inspirowani Naturą" ("Inspired by Nature") any activities regarding flowers and nature in cities since three years. If you look for inspirations for your place, visit our site www.inspirowaninatura.pl

Piotr Skubiszewski

Landschaftsarchitekt | +48 513 041 847 | piotr.skubiszewski@terra-uk.eu



ERSTKLASSIGE BLUMENKONSTRUKTION

THE EXCELLENT FLOWER TOWER

www.blumentuerme.de

www.terra-flower-tower.com



KASKADENKONSTRUKTION FLOWER TOWER

H 1150/750

Das neueste Modell unserer Kaskadenkonstruktionen ist eine perfekte Lösung für alle, die nach dem goldenen Mittelweg zwischen den höchsten Blumentürmen und unseren kleinsten Vorschlägen suchen. Dieser Blumenturm ermöglicht die Einführung von blumigen Akzenten in jeden Ort.

The latest model of the Flower Towers was created as a compromise between the largest and the smallest decorations. This compact model allows to launch nature almost into any location.

☰ 6 levels

📊 160 - 230 kg

💧 272 l

📏 1190 mm







H1150/750

H 1150/750



GEHWEG

Um die Gehwege zu verzieren, verwenden Sie schmale Konstruktionen H1150/750. Dank ihrer Form stören sie den Verkehr nicht und zugleich trennen sie die Fußgängerzone von belebter Straße ab.

PAVEMENT

If you want to decorate pavements, use constructions H1050. Thanks to their form, they don't make moving difficult for pedestrians. They also separate them from a busy street.

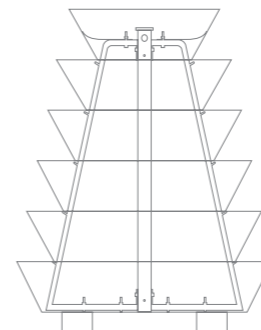
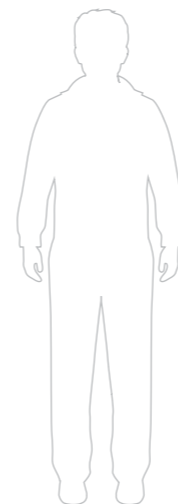

	Anzahl der Ringe levels	▶	6
	Fassungsvermögen capacity	▶	272 l
	Gesamthöhe total height	▶	1190 mm
	Basisdurchmesser bottom diameter	▶	750 mm
	Gewicht vor Bepflanzung weight before planting	▶	53 kg
	Gewicht nach Bepflanzung weight after planting	▶	160 - 230 kg
	Anzahl der Setzlinge estimated number of plants	▶	50 - 70
	Basisfarbe basic colour	▶	5
	Farbvarianten available colours	▶	1 2 3 4

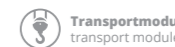
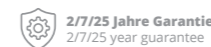



► AUSSERGEWÖHNLICHE STABILITÄT EXCEPTIONAL STABILITY

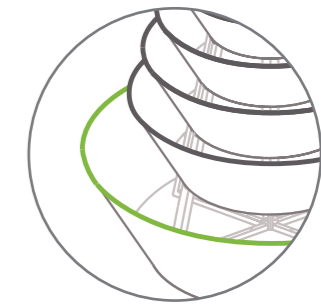

Bei der Gestaltung unserer neuesten Kaskadenkonstruktion haben wir uns zum Ziel gesetzt, eine optimale Höhe mit einer breiten Basis zu verbinden. So entstand eine Dekoration, die sich kaum umkippen lässt. Diese kleine Kaskade bietet hervorragende Gestaltungsmöglichkeiten. Der untere Ring ist so breit, dass er mehrere Setzlinge aufnehmen kann. So können Sie den Effekt eines wunderschönen, blumigen Teppich erreichen.

In our latest model, we focused first of all on combining the optimal height with a wide base, to create a decoration that is almost impossible to fall over. This small Flower Tower offers excellent arrangement possibilities: the bottom ring is wide enough to accommodate more seedlings, making the impression of a floral carpet at the base of the decoration.

Additional possibilities

Das Modell 1050 wurde so konzipiert, um die maximale Anzahl von Setzlingen schnell. Dort, wo eine ungestörte Sicht und Stabilität der Infrastruktur im Vordergrund stehen, müssen sorgfältig durchdachte Lösungen verwendet werden. Wir sind uns bewusst, dass obwohl auch an solchen Stellen grüne Akzente äußerst wertvoll sind, hat die Sicherheit oberste Priorität.

The design of the H1050 model was created to give the opportunity to easily and efficiently bring in the maximum number of seedlings. Street greenery, roundabouts, stairs by the squares - we are aware that also in these locations the element of greenery is extremely valuable, but safety always comes first.

Monika Zalewska

Key Account Specialist | +49 30 12 07 46 90 | monika.zalewska@terra-de.eu



BESTSELLER UNTER ALLEN KASKADENKONSTRUKTIONEN
THE MOST POPULAR MODEL

www.blumentuerme.de

www.terra-flower-tower.com



KASKADENKONSTRUKTION
FLOWER TOWER

H 1200

Diese große, aber nicht besonders hohe Konstruktion zeichnet sich mit Stabilität aus. Dank ihrer Größe kann sie in der Nähe von Bänken und Abfalleimern gestellt werden und so eine einheitliche Komposition mit anderen Elementen der Kleinarchitektur schaffen. Ihre Universalität ist der wichtigste Grund dafür, dass dieses Modell ein Bestseller wurde und sich immer größerer Popularität in vielen europäischen Städten erfreut.

A big, but not too much, construction is distinguished by stability. Thanks to its size, it doesn't disturb proportions in public space, so it can stand next to benches and bins, creating with them a coherent composition. Its universal application is the reason why H1200 has become our bestseller. It's popular in many European cities.

☰ 6 levels

⚖️ 355 - 660 kg

💧 668 l

⬆️ 1355 mm







MARKTPLATZ

Den Marktplatz kann man in fast allen europäischen Städten finden. Unabhängig von seiner Größe, Bebauung oder Architektur betont die Stadtverwaltung gerne seinen Charme. Oft ist es jedoch unmöglich, Bäume und Sträucher anzupflanzen. Dieses Problem lösen Kaskadenkonstruktionen. Nutzen Sie das Modell H1200 als natürliche Grenze zwischen dem Gehweg und der Straße!

TOWN SQUARE

Almost every city has an old market. Regardless its surface, municipal authorities do their best to accentuate the charm of this place. If traditional planting is impossible, Flower Towers will help. Create natural barriers from traffic thanks to the model H1200.

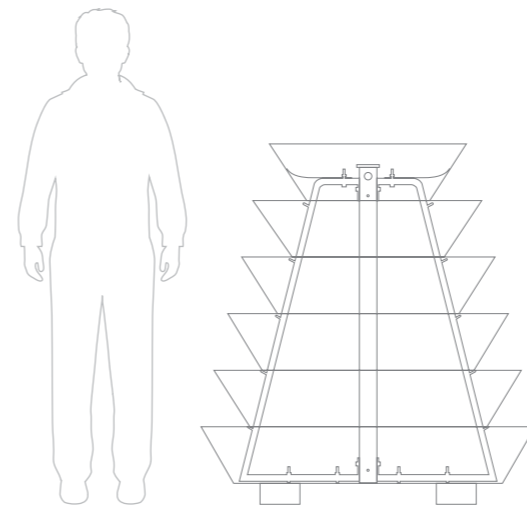

H 1200



	Anzahl der Ringe levels	▶	6
	Fassungsvermögen capacity	▶	668 l
	Gesamthöhe total height	▶	1355 mm
	Basisdurchmesser bottom diameter	▶	1200 mm
	Gewicht vor Bepflanzung weight before planting	▶	86 kg
	Gewicht nach Bepflanzung weight after planting	▶	355 - 660 kg
	Anzahl der Setzlinge estimated number of plants	▶	72 - 90
	Basisfarbe basic colour	▶	 5
	Farbvarianten available colours	▶	 1  2  3  4

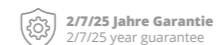

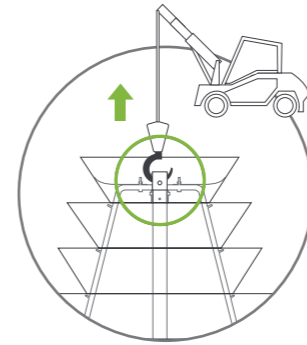

► TRANSPORTMODUL TRANSPORT MODULE

Funktionales System, das bequeme Entladung der bepflanztten Konstruktionen erleichtert und lässt das Risiko der Blumenbeschädigung reduzieren. Der sichere und widerstandsfähige Griff beschleunigt wesentlich den Prozess der Einführung von Produkten in den gewählten Raum.

The transport module consists of a safe and durable handle allowing to provide a decoration into urban space by using a special car. This functional system that makes unloading easier and accelerates the transport of constructions regardless their dimensions. It also guarantees no damage to flowers.



“*Catch it if you can!*”

Jeder mag bequeme und schnelle Lösungen. Jahrelange Erfahrung und wertvolle Hinweise unserer Kunden bilden eine gute Basis, um ein funktionales Transportmodul zu schaffen. Mithilfe eines hydraulischen Fahrzeugskrans kann man schnell und sicher bepflanzen Kaskadenkonstruktionen entladen oder umstellen.

All of us like comfortable and fast solutions. Years of experience and invaluable pieces of advice from our clients gave us foundations to create a functional transport system. Using a HDS crane, we can transport and unload stable and heavy constructions everywhere easily and safely.”

Boguslawa Wojtaszek

Key Account Specialist | +49 30 12 07 46 90 | boguslawa.wojtaszek@terra-de.eu



limpia Fitness Club
ul. P. J. PAWIA 117

Dom Chleba & Słodki Zakątek

PODLASKIE BIURO
NIERUCHOMOŚCI

SZM

WIZYTA NA
ZA DARMO!

Oczyść na
WAGĘ

CODE

ALTERNATIVE ZUR KLASSIK
ALTERNATIVE TO CLASSICS

www.blumentuerme.de

www.terra-flower-tower.com



KASKADENKONSTRUKTION
FLOWER TOWER

H 1200 $\frac{1}{2}$ $\frac{1}{4}$ $\frac{1}{2}$
ROUND

Dank origineller Form dieser Konstruktionen kann man Ecken oder Wände effektiv bepflanzen. Kaskadenkonstruktionen beheben kleine Fehler der Gebäudefassaden, verzieren Treppe, Eingänge oder andere schwer zugängliche Orte. Das ist der größte Vorteil dieser Modelle!

The innovative form of the construction was designed for corners and walls. Flower Towers cover the defects of facade, decorate stairs, gates, entrances and other problematic places. The arrangement of such places is the best advantage of these models.

$\frac{1}{2}$ $\frac{1}{2}$
ROUND

6 levels



180 - 300 kg



314 l



1355 mm

$\frac{1}{4}$

6 levels



96 - 150 kg



157 l



1355 mm







EINGANG

Eine effektvolle Gestaltung des Gebäudeeingangs gehört nicht zu einfachen Aufgaben. Wenn Sie sich für Halbmodelle der Kaskadenkonstruktionen entscheiden, erzielen Sie einen interessanten Dekorationseffekt, ohne viel Platz einzunehmen. Klassische Modelle werden sich auch hervorragend präsentieren – sie ermöglichen die Einführung des natürlichen Elements dort, wo die Blumen von Natur aus nicht wachsen könnten. Bei entsprechender Wahl der Bepflanzung können Sie auch die Einzigartigkeit der Architektur betonen.

ENTRANCE

A proper decoration of an entrance isn't an easy task. You need to remember not to limit its functionality. If you decide for the half models of Flower Towers, you'll need a minimum of space to revive it. Moreover, if you add flowers in matching colours, you can accentuate the architectural style of a building.

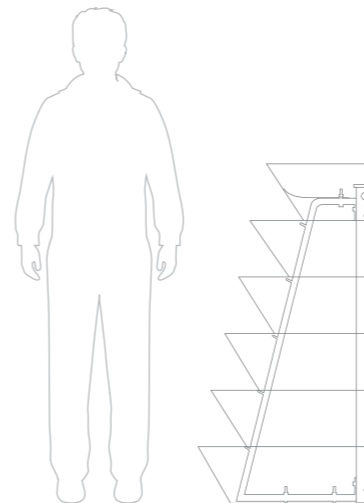

H 1200 ^{1/2}



eingang
entrance



gehweg
pavement



markplatz
town square

	Anzahl der Ringe levels	▶	6
	Fassungsvermögen capacity	▶	314 l
	Gesamthöhe total height	▶	1355 mm
	Basisdurchmesser bottom diameter	▶	½ 1200 mm
	Gewicht vor Bepflanzung weight before planting	▶	60 kg
	Gewicht nach Bepflanzung weight after planting	▶	180 - 300 kg
	Anzahl der Setzlinge estimated number of plants	▶	40 - 50
	Basisfarbe basic colour	▶	5
	Farbvarianten available colours	▶	1 2 3 4

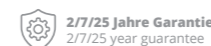

2/7/25 Jahre Garantie
2/7/25 year guarantee



Transportmodul
transport module

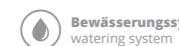

Bewässerungssystem
watering system



Diebstahlsicherung
anti-theft system

H1200 ½ A123

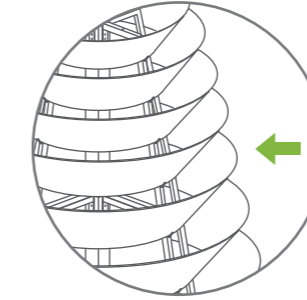

► ZINKSCHICHT HOT DIP GALVANIZING COATING

Das Geheimnis der Witterungsbeständigkeit liegt im Prozess der Verzinkung, dem alle Modelle unterliegen. Zinkschicht schützt die Konstruktionen vor Korrosion und ermöglicht ihre jahrelange Nutzung. Feuerverzinkung bildet auch eine gute Basis für Pulverfarbeschichtung.

The secret of resistance to weather conditions is the process of hot-dip galvanizing that each construction has to go through. Zinc coating protects from corrosion and allows to long-term use at the same time. Hot dip galvanizing coating is also a perfect base for powder coating.

“ For long years... ”

Seit über 15 Jahren verbinden wir sorgfältige Herstellung mit Innovation und bieten unseren Kunden Produkte höchster Qualität. Dank der Verbindung des Wissens von Produktionsexperten, Designern und Landschaftsarchitekten sind Terra-Produkte immer innovative Lösungen von höchster Qualität. Ihr wichtigster Vorteil ist die Beständigkeit, die aus hochwertigen Materialien und fortgeschrittenen Herstellungsmethoden resultiert

We've been offering our clients the products of high quality since over 15 years by combining the workmanship and innovation. Thanks to the integration of the knowledge of production specialists, designers and landscape architects, our products are always innovative solutions of the highest level of safety and quality. Their most important feature is longevity achieved by choosing only the best materials and advanced methods of production.

Julita Sobczyk

Key Account Specialist PL | +48 695 066 666 | julita.sobczyk@terra-pl.eu

H 1200 ^{1/4}



ingang
entrance



gehweg
pavement



markplatz
town square

	Anzahl der Ringe levels	▶	6
	Fassungsvermögen capacity	▶	157 l
	Gesamthöhe total height	▶	1355 mm
	Basisdurchmesser bottom diameter	▶	¼ 1200 mm
	Gewicht vor Bepflanzung weight before planting	▶	17 kg
	Gewicht nach Bepflanzung weight after planting	▶	96 - 150 kg
	Anzahl der Setzlinge estimated number of plants	▶	20 - 25
	Basisfarbe basic colour	▶	030
	Farbvarianten available colours	▶	032 033 034 035

2/7/25 Jahre Garantie
2/7/25 year guarantee

Transportmodul
transport module

Bewässerungssystem
watering system

Diebstahlsicherung
anti-theft system

H 1200 ^{1/2} ROUND



ingang
entrance



gehweg
pavement



markplatz
town square



kreisverkehr
roundabout

	Anzahl der Ringe levels	▶	6
	Fassungsvermögen capacity	▶	307 l
	Gesamthöhe total height	▶	1355 mm
	Basisdurchmesser bottom diameter	▶	½ 1200 mm
	Gewicht vor Bepflanzung weight before planting	▶	60 kg
	Gewicht nach Bepflanzung weight after planting	▶	180 - 300 kg
	Anzahl der Setzlinge estimated number of plants	▶	40 - 50
	Basisfarbe basic colour	▶	030
	Farbvarianten available colours	▶	032 033 034 035

2/7/25 Jahre Garantie
2/7/25 year guarantee

Transportmodul
transport module

Bewässerungssystem
watering system



H1200 1/4



A123

EIN ECHTER BLICKFANG
IMMOVABLE GIANT

www.blumentuerme.de

www.terra-flower-tower.com



KASKADENKONSTRUKTION
FLOWER TOWER

H 2000

Eines der höchsten Modelle, das sich mit sicherer und stabiler Konstruktion auszeichnet. Es bewährt sich als Orientierungspunkt oder bunter Akzent im Stadtraum. Solche Dekoration ist nicht zu übersehen!

One of the biggest models that is distinguished by its safe and stable construction. If you set it in the city centre, it can serve to citizens as an orientation point or a colourful and visible accent in public space. Its charm catches the eye.

☰ 9 levels



600 - 1150 kg



1168 l



1990 mm





SEWU, MUZYKI,
TORSTWA
ZAPISZ SIĘ!

SERVICE CAR

pię

JU
OTWAR



H2000



STRASSE

Verwandeln Sie die Straße in einen bunten, einwohnerfreundlichen Ort! Kaskadenkonstruktionen H2000 bewährten sich dort, wo die Einführung grüner Elemente besonders problematisch ist. Sie beschränken keine Sicht, was für die Autofahrer sehr wichtig ist.

STREET

Turn a street into a colourful and friendly place in a very simple way. Flower Towers H2000 are the best at decorating the surroundings without nature and, what is the most important, they don't reduce visibility for drivers and pedestrians.

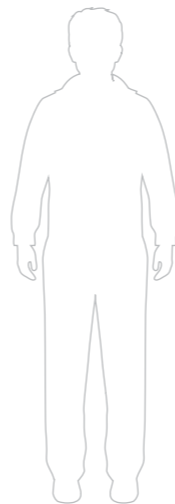

H 2000



park
park



springbrunnen
fountain



marktplatz
town square



kreisverkehr
roundabout



denkmal
monumen

	Anzahl der Ringe levels	▶	9
	Fassungsvermögen capacity	▶	1168 l
	Gesamthöhe total height	▶	1990 mm
	Basisdurchmesser bottom diameter	▶	1200 mm
	Gewicht vor Bepflanzung weight before planting	▶	124 kg
	Gewicht nach Bepflanzung weight after planting	▶	600 - 1150 kg
	Anzahl der Setzlinge estimated number of plants	▶	110 - 130
	Basisfarbe basic colour	▶	5
	Farbvarianten available colours	▶	1 2 3 4



2/7/25 Jahre Garantie
2/7/25 year guarantee



Bewässerungssystem
watering system



Diebstahlsicherung
anti-theft system

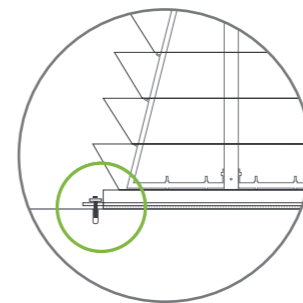

► **DIEBSTAHLSICHERUNG** ANTITHEFT SYSTEM

Sichere und dauerhafte Lösung, die unsere Produkte vor Diebstahl oder Akte des Vandalismus schützt. Dank der stabilen und widerstandsfähigen Bodenbefestigung bleibt die Kaskaden-Blumenständerkonstruktion an ihrem Bestimmungsort.

The safe and solid solution that eliminates losses caused by robbery. The steel element of high quality guarantees effectiveness of anti-theft system. Stable and durable installation to the ground makes constructions immovable.



„*Sleep well!*“

Wir kümmern uns um Ihre Ruhe. Aus diesem Grund haben wir Diebstahlsicherung gestaltet. Nach vielen Jahren der Analyse und zahlreichen Gesprächen mit unseren Kunden schaffen wir Kaskadenkonstruktionen, die sich im Stadtraum bewähren. Beständiges Material und innovative Befestigung schrecken potentielle Vandalen und Diebe ab.

We want all our clients to sleep well, so the anti-theft system is our answer for their fear of vandalism and robbery. After many years of analyses, experience and consultations with clients, we managed to create constructions that are resistant to any threat. The durable material and innovative fixing system discourage potential vandals and thieves.

Agnieszka Piotrowska

Key Account Specialist PL | +48 667 107 777 | agnieszka.piotrowska@terra-pl.eu

H 2000 ^{1/2}



ingang
entrance



gehweg
pavement



denkmal
monumen



Anzahl der Ringe
levels

▶ 9



Fassungsvermögen
capacity

▶ 584 l



Gesamthöhe
total height

▶ 1990 mm



Basisdurchmesser
bottom diameter

▶ ½ 1200 mm



Gewicht vor Bepflanzung
weight before planting

▶ 62 kg



Gewicht nach Bepflanzung
weight after planting

▶ 300 - 575 kg



Anzahl der Setzlinge
estimated number of plants

▶ 55 - 65







Basisfarbe
basic colour

▶  030



Farbvarianten
available colours

▶  032  033
 034  035



27/25 Jahre Garantie
27/25 year guarantee



Bewässerungssystem
watering system



Diebstahlsicherung
anti-theft system

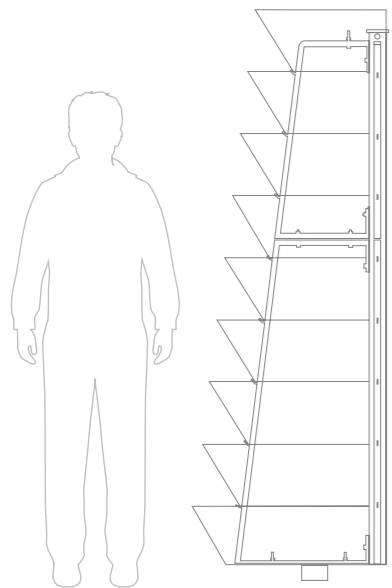

 H2000 1/2

 A116

BLÜHENDE PYRAMIDE
FLORAL PYRAMID

www.blumentuerme.de

www.terra-flower-tower.com



KASKADENKONSTRUKTION
FLOWER TOWER

H 2400

In dieser riesigen Konstruktion passen bis 200 Setzlingen hinein. Sie lassen den Effekt der blühenden Kugel erzielen. Dank der großen Fläche können die angepflanzten Blumen verschiedene Muster wie z.B. Spirale oder Schachbrett annehmen.

This huge construction contains even up to 200 plants that create a beautiful flower tower after blooming. Thanks to such big surface, flowers can form various patterns, for example check or spiral. It depends only on your imagination. This huge volcano of flowers is immovable.

☰ 12 levels



710 - 1300 kg



1335 l



2610 mm







H2400

PARK

Parks spielen die Rolle der grünen Lungen der Stadt. Das ist auch ein perfekter Ort für Blumensäulen. Sorgfältig gewählte Bepflanzung lässt die wichtigsten Elemente der Komposition betonen. Wenn Sie nicht sicher sind, welche Blumen sich am besten bewähren, schauen Sie sich unsere Vorschläge an.

PARK

Park is considered green lung of the city. Despite the omnipresent greenery, it's also a great place for Flower Towers. If you match flowers and models properly, you can decorate park avenues and accentuate the most significant points.

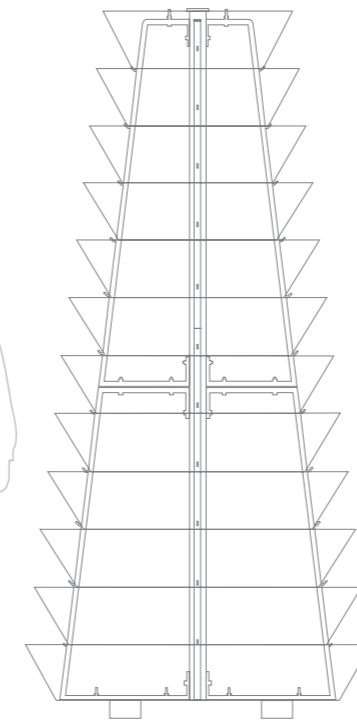
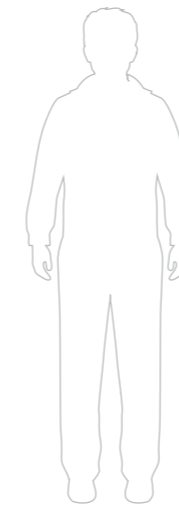

H 2400



straße
street



springbrunnen
fountain



marktplatz
town square



park
park



denkmal
monumen

	Anzahl der Ringe levels	▶	12
	Fassungsvermögen capacity	▶	1335 l
	Gesamthöhe total height	▶	2610 mm
	Basisdurchmesser bottom diameter	▶	1200 mm
	Gewicht vor Bepflanzung weight before planting	▶	147 kg
	Gewicht nach Bepflanzung weight after planting	▶	710 - 1300 kg
	Anzahl der Setzlinge estimated number of plants	▶	145 - 180
	Basisfarbe basic colour	▶	5
	Farbvarianten available colours	▶	1 2 3 4

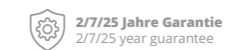

2/7/25 Jahre Garantie
2/7/25 year guarantee

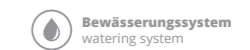

Bewässerungssystem
watering system

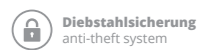

Diebstahlsicherung
anti-theft system



H2400

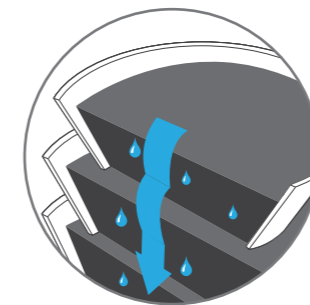

► KASKADENSYSTEM CASCADE SYSTEM

Mit Patent geschütztes System offener Ringe. Als Basis jedes Modells dient die Bodenschale. Diese innovative Lösung erhöht wesentlich Effektivität und Qualität des Pflanzenanbaus. Da die einzelnen Schichten der Blumenständerkonstruktion keinen Boden besitzen, haben die Pflanzenwurzeln optimale Wachstumsbedingungen sowie entsprechende Wasser- und Luftmenge. Im Endeffekt entsteht eine üppige Bepflanzung, die die Stahlkonstruktion völlig bedeckt.

The patent system of open rings that creates a Flower Tower. The base of each model is a large bowl. This innovative solution gives plants unrestrained growth conditions, appropriate access to water and nutrients and also an optimal air circulation in root system. The effect is the improvement of effectiveness and quality of plants and the reduction of their loss. In result, the whole construction is covered with luxuriant flowers.

“ *Let your city flourish...* ”

Was ist ein Kaskadensystem? Das ist viel mehr als nur charakteristische Form unserer Produkte. Wir schufen das System, das den Setzlingen freie Entwicklung garantiert. Diese innovative, patentgeschützte Lösung erhöht Effektivität der Anpflanzungen. Diese Methode sichert den Pflanzen optimale Wasser- und Luftmenge und dem Wurzelsystem – freies Wachstum. Vertrauen Sie unserem Wissen und lassen Sie Ihre Stadt aufblühen...

What is a cascade system? It's something more than a characteristic shape of our products. We're the authors of a unique idea that guarantees unrestrained growth conditions of plants. This innovative and patent solution increases the quality of flowers. Thanks to the cascade arrangement of rings, an optimal amount of water and air is distributed to plants, and their root system can develop freely. Trust us and let your city flourish...

Katarzyna Śliwińska

Key Account Specialist PL | +48 605 065 555 | katarzyna.sliwinska@terra-pl.eu

IHRE HOHEIT NATUR
ITS HIGHNESS NATURE

www.blumentuerme.de

www.terra-flower-tower.com



KASKADENKONSTRUKTION FLOWER TOWER

H 3000

Eine der höchsten Konstruktionen, die mit ihren Möglichkeiten begeistert. In 15 Stufen kann man über 200 Setzlinge anpflanzen, was einen originellen Dekorationseffekten erzielen lässt. Das ist ein interessanter, bunter Akzent und zugleich eine jahrelange Garantie der Sicherheit und Stabilität.

One of the biggest constructions with huge possibilities. 15 levels can contain over 200 seedlings. It allows to achieve an interesting and colourful decoration which is safe and stable. The construction will last many years.

☰ 15 levels



1400 - 1600 kg



1390 l



3105 mm





H3000 A116



PLATZ IM STADTZENTRUM

Das Herz vieler europäischer Städte bildet ein riesiger, oft gepflasterter Platz. So ausgedehnte Fläche ohne natürlichen Boden ist eine große Herausforderung! Ihre Eintönigkeit können blumige Dekorationen brechen. Nur so große Blumenkonstruktionen wie H3000 können diese Aufgabe bewältigen.

COBBLESTONE SQUARE

A cobblestoned square is the heart of almost every Polish city. Such a big place without trees or flowers could be a real challenge! This monotony can be broken with floral decorations. The model H3000 will come up to your expectations.

H 3000

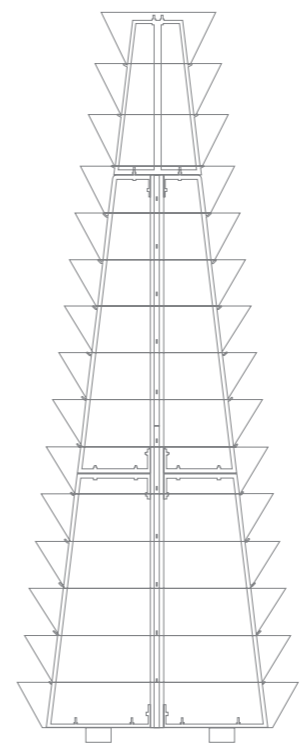
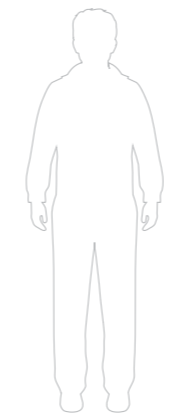

	Anzahl der Ringe levels	▶	15
	Fassungsvermögen capacity	▶	1390 l
	Gesamthöhe total height	▶	3105 mm
	Basisdurchmesser bottom diameter	▶	1200 mm
	Gewicht vor Bepflanzung weight before planting	▶	175 kg
	Gewicht nach Bepflanzung weight after planting	▶	1400 - 1600 kg
	Anzahl der Setzlinge estimated number of plants	▶	165 - 215
	Basisfarbe basic colour	▶	5
	Farbvarianten available colours	▶	1 2 3 4

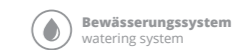
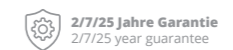



H3000



AT16

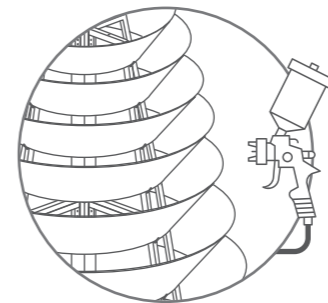

► **PULVERFARBESCHICHTUNG (DUPLEX)**
LACQUER COLOUR DUPLEX SYSTEM

Attraktives Aussehen und interessanter Dekorationseffekt gehören zu den größten Vorteilen der Kaskadenkonstruktionen. Über ihre Ästhetik entscheidet in hohem Maße die Pulverfarbe, die Stahlelemente der Konstruktion beschichtet. Ihre Anwendung resultiert aber nicht aus ästhetischen Gründen – die Pulverfarbeschicht, die das Auge erfreut, bildet zugleich ein zusätzlicher Korrosionsschutz.

The biggest advantages of the Flower Towers are a good appearance and an impressive effect. Such a result is possible thanks to a lacquered layer that covers our constructions. Its application also gives a long lasting protection against corrosion.



“ **Big can do more!** ”

In unser Angebot haben wir noch größere Modelle der Kaskadenkonstruktionen eingeführt. 3 Meter hoher Blumenturm eröffnet viele Arrangementsmöglichkeiten und lässt die Farben beliebig komponieren. Wichtig ist, dass das Modell H3000 trotz seiner Größe stabil bleibt. Aus diesem Grund ist er eine sichere Dekoration für jeden Stadtraum.

We have recently added even larger Flower Towers. Despite its size, the model H3000 is stable but still a very safe decoration perfect for urban space arrangement.

Iwona Podlewska

Key Account Specialist PL | +48 513 041 846 | iwona.podlewska@terra-pl.eu

BLUMIGER BERG
A PILE OF FLOWERS

www.blumentuerme.de

www.terra-flower-tower.com



KASKADENKONSTRUKTION
FLOWER TOWER

H 3400

Die größte unter allen unseren Kaskadenkonstruktionen. Die aus 17 Ringen bestehende Konstruktion bietet gestalterische Freiheit und ermöglicht eine Dekoration aus sogar 230 Setzlingen zu schaffen. Das ist die einzige Lösung, welche so eine riesige Menge an Pflanzen in den Raum gleichzeitig einführen lässt. Ihr größter Vorteil liegt in ihrer Stabilität und Sicherheit.

The largest of all Flower Tower constructions. The H3400 Flower Tower, containing 17 rings, gives unlimited compositional possibilities and allows to create decorations of up to 230 seedlings. This is the only solution that let you bring so many plants into the space at the same time. Stability and reliability are its great advantages!

☰ 17 levels



1800 - 2000 kg



1490 l



3435 mm





H3400



A117



GRÜNANLAGE VOR DEM RATHAUS

Der Raum direkt vor den Verwaltungsgebäuden verdient eine besondere Aufmerksamkeit.

Blumige Akzente können das Image der Stadtverwaltung positiv beeinflussen, sie werten auch die Gebäude ästhetisch auf. Natürliche Elemente sind eine bewährte Methode, um diesen Effekt zu verstärken. Der riesige Blumenturm H3400 verwandelt jeden Ort in eine blühende Oase!

THE SQUARE IN FRONT OF THE OFFICE

The space directly in front of the administrative buildings is a place especially worth emphasizing. Properly arranged surroundings of the city hall or town hall have a positive effect on its reception among residents, and also improves the aesthetics of the buildings. The presence of nature also contributes to a friendly image, and there is never too much of it: the large H3400 Flower Tower will turn the surroundings into a blooming oasis!

H 3400



springbrunnen
fountain



marktplatz
town square



park
park



denkmal
monumen

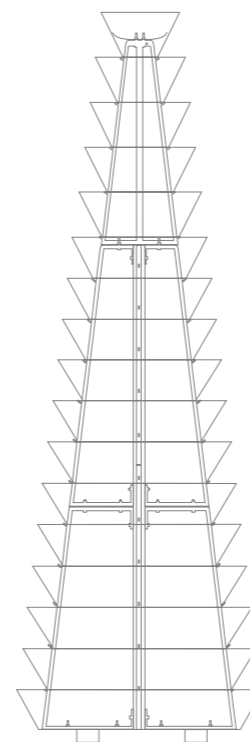

	Anzahl der Ringe levels	▶	17
	Fassungsvermögen capacity	▶	1490 l
	Gesamthöhe total height	▶	3435 mm
	Basisdurchmesser bottom diameter	▶	1200 mm
	Gewicht vor Bepflanzung weight before planting	▶	190 kg
	Gewicht nach Bepflanzung weight after planting	▶	1800 - 2000 kg
	Anzahl der Setzlinge estimated number of plants	▶	185 - 230
	Basisfarbe basic colour	▶	5
	Farbvarianten available colours	▶	1 2 3 4

2/7/25 Jahre Garantie
2/7/25 year guarantee

Bewässerungssystem
watering system

Diebstahlsicherung
anti-theft system

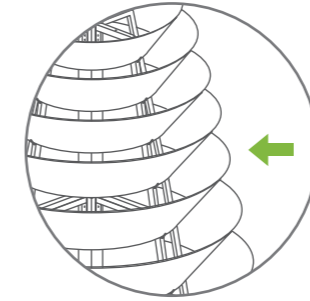

► ROSTFREIER STAHL STAINLESS STEEL

Die aus Edelstahl gefertigten Elemente überzeugen durch eine glatte Oberfläche und einen charakteristischen Glanz. Ihr größter Vorteil liegt aber in einer besonders hohen Robustheit, Korrosionsbeständigkeit und Säureresistenz. Die Verwendung dieser Materialvariante garantiert einen sicheren Einsatz unserer Kaskadenkonstruktionen unter beinahe allen Bedingungen: in der Nähe von belebten Straßen, an Orten mit starken Regenfällen oder in einer salzhaltigen Umgebung.

The elements made of stainless steel are smooth and shiny, which improves the aesthetics. However, above all, they are extremely durable and resistant to corrosion, and even the destructive effects of acids. The use of this material in the production of Flower Towers allows for safe display of the decorations near crowded streets, in places exposed to heavy rainfall or in a salty environment.

“ Rise to the challenge

Es liegt uns sehr daran, damit unsere Kunden an der Gestaltung neuer Kaskadenkonstruktionen aktiv teilnehmen. Ihre Bemerkungen und Hinweise sind für uns besonders wertvoll, weil sie als zukünftige Benutzer unserer Kaskadenkonstruktionen am besten wissen, welche Bedürfnisse die Stadtdenkmäler erfüllen sollten. Als Antwort auf einen der Vorschläge haben wir das Modell H3400 entwickelt - die größte Kaskade, die ca. 230 Setzlinge aufnehmen kann. Dies ist die einzige so riesige und gleichzeitig so stabile Dekoration, die speziell für den öffentlichen Raum konzipiert wurde.

We strive to ensure that our clients have their share in creating the offer of The Flower Towers. The remarks and tips of future users are the most valuable to us, because they know best what is missing in their surroundings. As a response to one of these suggestions, we created H3400 - the largest Flower Tower that can hold up to 230 seedlings. It is the only construction of this size on the market and at the same time, it is a stable decoration dedicated to public spaces.”

Daniela Domjenová

Key Account Specialist CZ/SK | +420 731 060 219 | daniela.domjenova@terra-cz.eu

Wussten Sie, dass...

► ANBAU-EINLAGE

mehr Info: S. 106

Jetzt ist der Bepflanzungswechsel ohne Demontage der Blumenampeln möglich! Das ist ein spezieller Pflanzbehälter, welcher einen blitzschnellen, kinderleichten Bepflanzungswechsel ohne Demontage der Blumenampeln ermöglicht.

► EFFEKT EINER BLÜHENDEN KUGEL

Um die Bedürfnisse der Stadtarchitektur zu befriedigen, hat die Firma Terra Kaskaden-Blumenampeln geschaffen. Diese mit Patent geschützten Produkte sind einzige Blumenbehälter dieser Art in Europa. Voll bepflanzt lassen sie einen ungewöhnlichen Effekt einer blühenden Kugel erzielen.

► BEWÄSSERUNGSSYSTEM + DOPPELTER BODEN

Spezielles Modul der Kontrolle und Versorgung entsprechender Wassermenge direkt zum Wurzelsystem von Pflanzen. Die Überlauföcher regulieren optimale Wassermenge im Behälter – gleichzeitig verhindern sie das Verwesen der Pflanzen beim Wasserüberfluss. Zusätzliches Bewässerungssystem garantiert nicht nur den Nutzungskomfort, sondern auch lässt die Pflegekosten reduzieren.

► BEFESTIGUNGEN FÜR JEDE STRASSENLATERNE

Breite Befestigungspalette ermöglicht die Montage der Blumenampel an fast jede Straßenlaterne. Spezielle Konstruktion und zur Herstellung der Griffe verwendetes Material garantieren sichere Nutzung und schützen die Außenschicht der Straßenlaterne.

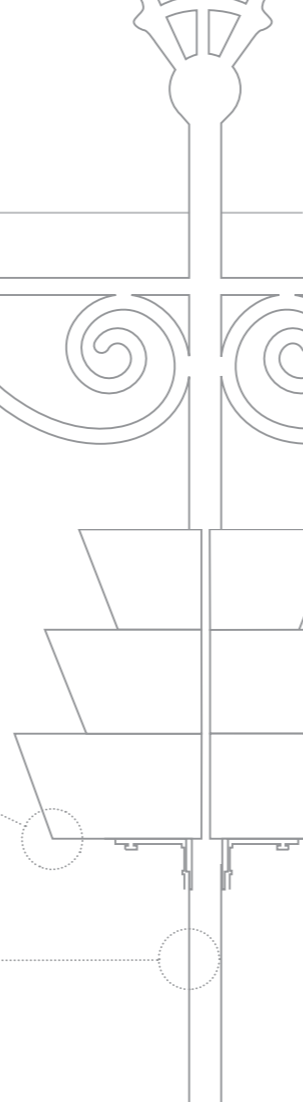
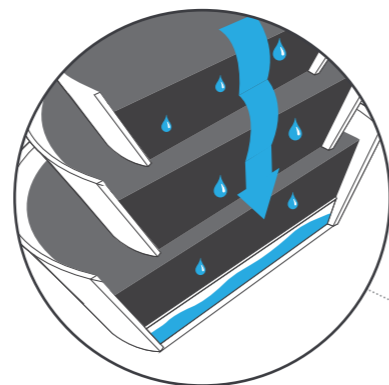

Wählen Sie Ihr Modell



W600/1

Erreichen Sie den Effekt einer blumigen Schüssel über den Köpfen der Passanten.



W600/2

Schaffen Sie eine blumige Dekoration mit kleinerer Menge der Setzlinge.



W600/3

Schaffen Sie eine effektvolle, blühende Kugel auf Straßenlaternen.

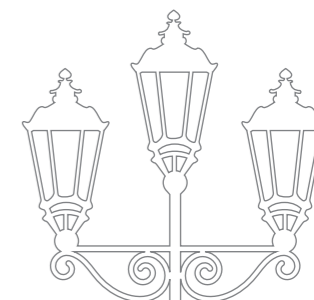

W800/1

Noch mehr Blumen auf Straßenlaternen.

NEUES MODELL

1/2

Auch in halbkreisförmiger Version erhältlich

NEUES MODELL

1/2

Auch in halbkreisförmiger Version erhältlich

NEUES MODELL

Do you know that...

► CULTIVATION INSERT

more info: s. 110

Change of plantings without dismantling the whole construction! It is a special plant container, which makes it possible to change plantings without disassembling the decoration – fast and without any complicated works.

► THE EFFECT OF FLORAL SPHERE

Thinking about small urban architecture, we created the models designed for lamps. These patent products are the only such containers for flowers in Europe. When they are fully planted, they look like floral spheres.

► WATERING SYSTEM + DOUBLE BOTTOM

A special module that controls and supplies water directly to the root system of plants. Overflow holes regulate optimal amount of water a container, preventing flowers from rotting if there's too much of it. Additional watering system provides comfort and reduces money spent on maintenance.

► FIXING SUITABLE FOR EVERY LAMP

A wide range of grips enables a fixing of a construction on almost every street lamp. A special structure and material used in grip production guarantees safe use and the lamp coat protection at the same time.

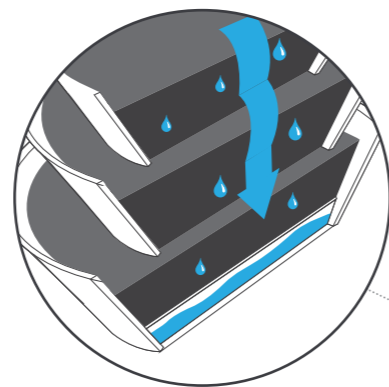

Choose your model

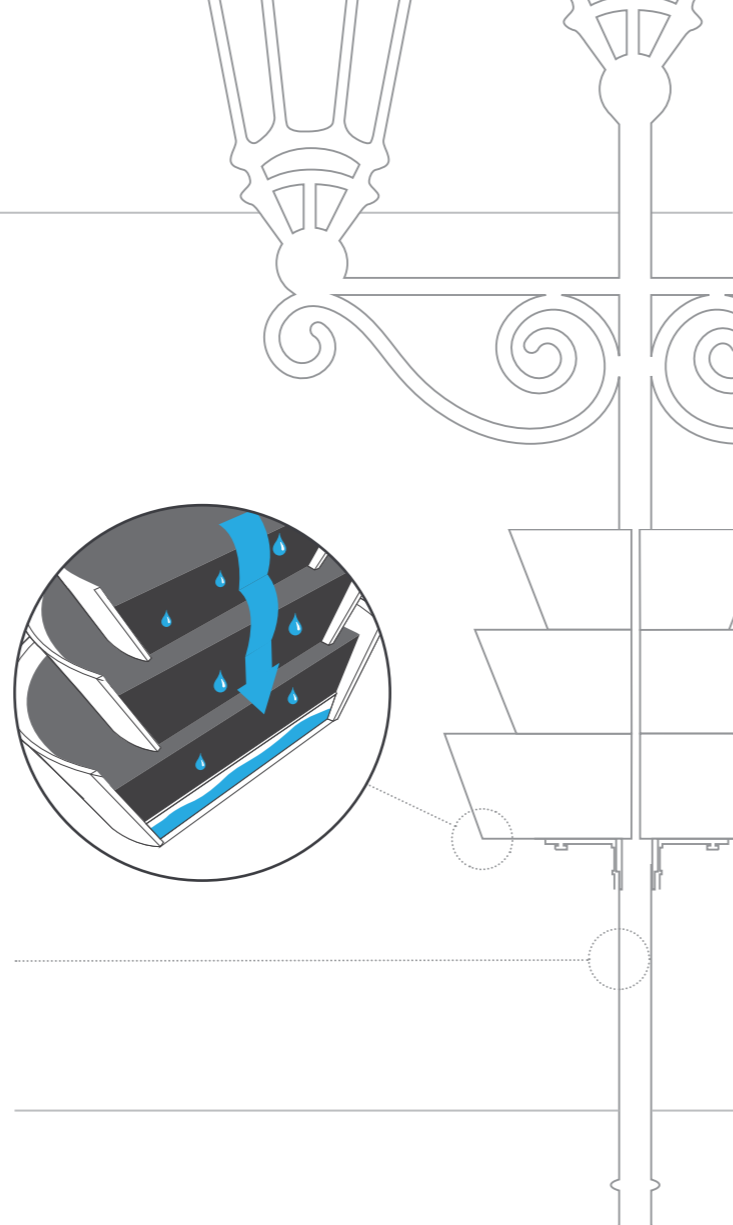

W600/1

Get an interesting effect of a floral bowl above pedestrians' heads.



W600/2

Built an impressive floral decoration with a smaller amount of plants.



W600/3

Create a beautiful floral sphere on street lamp lamps.

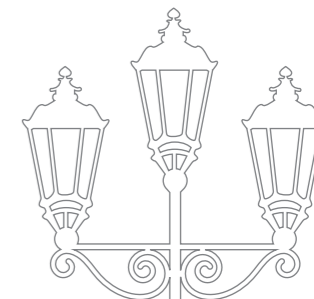

W800/1

Even more flowers on street lamps.

NEW MODEL

NEW MODEL

1/2

The 1/2 Flower Tower version available.

NEW MODEL

1/2

The 1/2 Flower Tower version available.

ANBAU-EINLAGE **CULTURE TUB**

Jetzt ist der Bepflanzungswechsel ohne Demontage der Blumenampeln möglich!

Wie funktioniert die Einlage?

Das ist ein spezieller Pflanzbehälter, welcher einen blitzschnellen, kinderleichten Bepflanzungswechsel ohne Demontage der Blumenampeln ermöglicht.

Entdecken Sie Ihre Vorteile:

1. WENIGER ARBEITSAUFWAND

Der Bepflanzungswechsel nimmt deutlich weniger Zeit in Anspruch.

2. KEIN RISIKO DER BESCHÄDIGUNG

Die Blumenampel bleibt auf der Straßenlaterne. Sie wechseln nur die leichte, mobile Einlage.

Die Einlage ist mit einem System von Überlauföchern ausgestattet. Solche Lösung verhindert das Verwesen der Pflanzen auch bei heftigen Regenfällen.

MIT DER ANBAU-EINLAGE
CULTURE TUB BEPFLANZEN
SIE DIE STRASSENLATERNEN
IN
60 SEKUNDEN!

Die Anbau-Einlage Culture Tub wird aus Polypropylen hergestellt. Dieses Material ist beständig gegen mechanische Beschädigungen und zugleich ökologisch, weil es durch Recycling wiedergewonnen wird. Das hilft das Image einer umweltfreundlichen Stadt aufzubauen.

DER BEPFLANZUNGSWECHSEL WAR
NOCH NIE SO EINFACH!

SOFORTIGER EFFEKT 3.

Der Bepflanzungswechsel dauert nur wenige Augenblicke und die Blumen in einer neuen Einlage sind völlig aufgeblüht.

LAGERPLATZERSPARNIS 4.

Sie wechseln nur die Einlage und müssen nicht die ganze Blumenampel demontieren oder lagern.

KEINE WARTUNG 5.

Bei der Bepflanzung kann eventuell nur die Einlage beschädigt werden – und sie kostet deutlich weniger als die Blumenampel.

BESSERE WACHSTUMSBEDINGUNGEN UND SCHÖNERE PFLANZEN 6.

Die doppelte Wand schafft eine zusätzliche Isolierungsschicht – die Temperatur des Bodens steigt viel langsamer.

BLUMENAMPPEL
MUSS DAS GANZE
JAHR ÜBER NICHT
DEMONTIERT
WERDEN



BLUMENAMPPEL W800/1

ANBAU-EINLAGE CULTURE TUB

DAS IST **SO EINFACH!**



1. Frühlingsbepflanzung

Wählen Sie Stiefmütterchen oder Gänseblümchen? Vergessen Sie nicht, dass die erste Anpflanzungen schon im März beginnen!



2. Sommerbepflanzung

Nach der Blütezeit der Frühlingsblumen entfernen Sie die Einlage mit dem Pflanzenmaterial und ersetzen Sie diese mit einer früh vorbereiteten Sommerkomposition. Surfinien und Geranien bewähren sich perfekt im Stadtraum!



3. Herbstbepflanzung

Auch in der Herbstzeit können die Straßenlaternen in Ihrer Stadt in wenigen Augenblicken aufblühen! Es reicht, die Einlage mit verblühten Sommerpflanzen gegen die Einlage voller Heidekraut auszutauschen.



4. Winterzeit

Vergessen Sie nicht, dass Sie im Winter die Blumenampeln nicht demontieren müssen. Es reicht, die Konstruktionen mit einem Weihnachtsüberzug aus Fichtennadeln zu bedecken. So gewinnen Sie eine wunderschöne Weihnachtsdekoration und sparen Sie den Lagerplatz und die Lagerkosten.

mehr erfahren:
www.terrachristmas.de

CULTIVATION INSERT **CULTURE TUB**

Change of plantings without dismantling the whole construction!

What and how?

It is a special plant container, which makes it possible to change plantings without disassembling the decoration – fast and without any complicated works.

Check what you can gain:

1. SAVE WORKING TIME

Less operating hours for assembly and disassembly of plantings

2. NO DAMAGE TO THE CONTAINER

The hanging Flower Tower stays on a lamp. Just change a culture tub for new one, full of flowers

Culture Tub is equipped with an overflow hole system, preventing rotting of plants due to excess water, (for example after heavy rain).

WITH CULTURE TUB YOU WILL PLANT A STREET LAMP IN 60 SECONDS!

NO NEED TO DISASSEMBLY THE CONTAINER ALL YEAR ROUND

Culture Tub is made of polypropylene - a material extremely resistant to any damage, and at the same time ecological, because obtained through recycling. It's an idea for building the image of an environmentally friendly city.

CHANGING OF PLANTINGS **HAS NEVER BEEN EASIER!**

IMMEDIATE VISUAL **3. EFFECT**

Changing the flowering takes a few moments, the flowers in the new insert are in full bloom right away

NO CONTAINER STORAGE **4.**

While changing the insert, you do not have to disassembly the whole container and store it. Just change the planted insert

SAVING ON SERVICE **5.**

Possible damage while planting can happen only to the insert, which is much cheaper than the hanging Flower Tower itself

BETTER GROWING CONDITIONS FOR **6. PLANTS AND THEIR BEAUTIFUL LOOK**

Double wall are an insulator - the soil in the container does not heat up so quickly

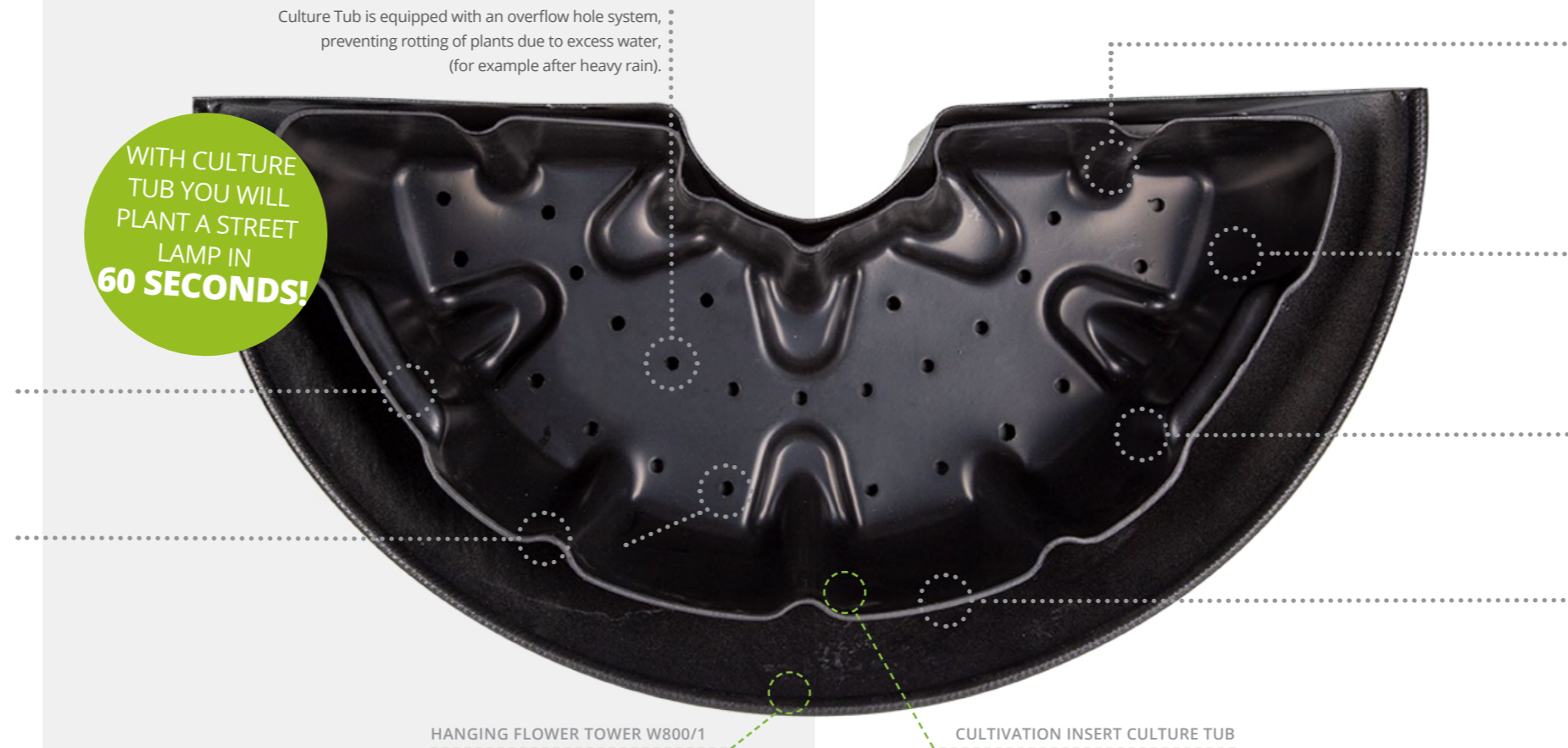

HANGING FLOWER TOWER W800/1

CULTIVATION INSERT CULTURE TUB

FIND OUT **HOW SIMPLE IT IS**



1. Spring Flowers

Will you choose pansies or daisies? Remember that spring plantings start already in March!



2. Summer Flowers

After the flowering period of spring specimens, remove the insert with plants and replace it with a previously prepared summer composition. Surfinia and geranium are a sure choice for your city.



3. Autumn planting

In autumn, street lamps in your city can also flourish ... and in a blink of an eye! In this period of the year replace the insert with fading summer plants with a previously prepared heather insert.



4. Winter time

Remember that in winter you do not have to disassemble the hanging Flower Towers. All you need to do is cover them with a Christmas Spruce Cover. You gain a Christmas decoration, and at the same time, you protect the container, saving costs and space for its traditional storage.

BLUMIGE SCHÜSSEL
FLOWER BOWLS

www.blumentuerme.de

www.terra-flower-tower.com

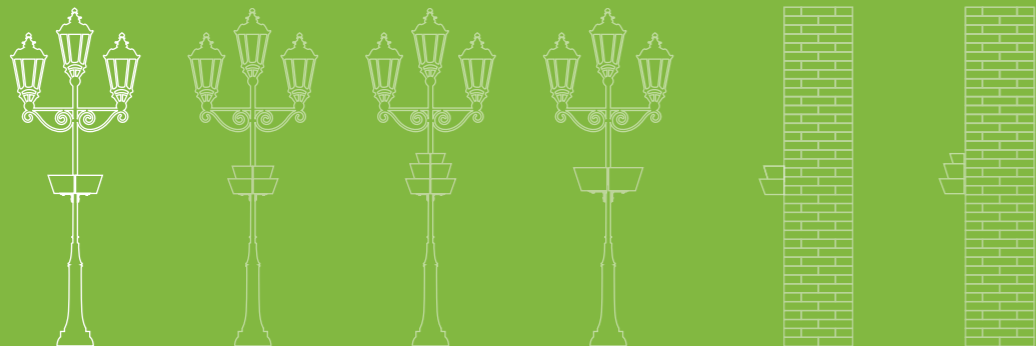

KASKADENKONSTRUKTION
FLOWER TOWER

W 600/1

Diese hängende Kaskadenkonstruktion bringt mit sich viele Vorteile. Das ist eine Garantie der schön bepflanzten Straßenlaternen und ein einzigartiger Effekt einer bunten Schüssel über den Köpfen der Passanten. Die Blumenampeln sichern den Pflanzen entsprechende Wachstumsbedingungen und ermöglichen die Einführung blumiger Akzente auch dort, wo es an natürlichem Boden fehlt.

This hanging container provides a number of benefits: beautifully flowered street lamps, and in addition, a unique effect of a colorful bowl over the heads of passersby. The flowers planted in it have the best conditions for growth and in a short time they create colorful compositions also in places without natural ground.

☰ 1 level

👤 2 x 12-21 kg

💧 46 l

⚡ 220 mm

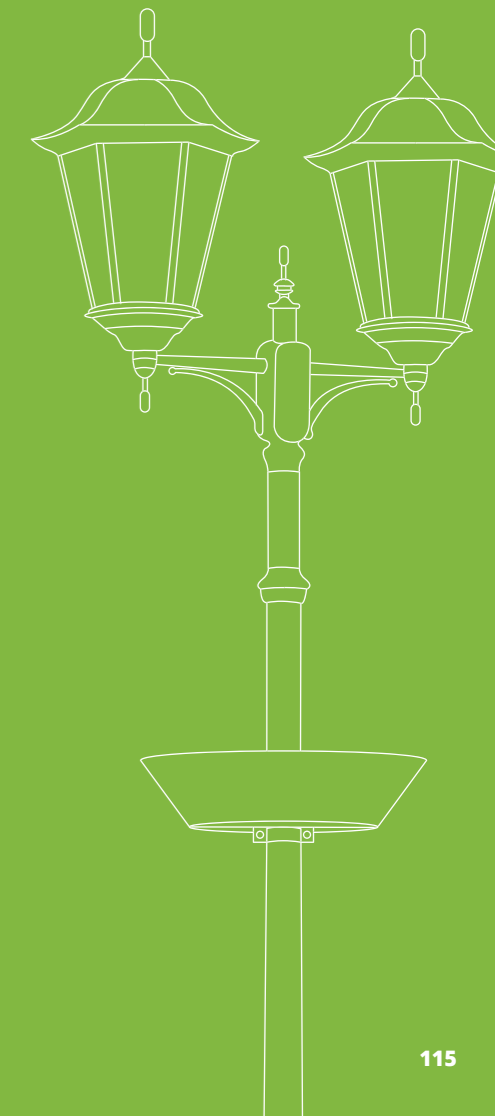



SOMMERGARTEN

Die Sommergärten gehören zu den populärsten Orten für Treffen und Erholung. Es lohnt sich, diesen Raum von dem Marktplatz abzutrennen.

Die Blumenampeln W600/1 bewähren sich hervorragend in dieser Rolle. Dank der Montage an die Straßenlaternen sind sie sehr platzsparend und können auch dort, wo jeder Zentimeter zählt, erfolgreich eingesetzt werden.

GARDEN CAFE

Summer cafe gardens are popular places to meet and relax. Their space should be separated from the market square - for this purpose, it is worth choosing hanging Flower Towers W600 / 1, which, thanks to their installation on street lamps, also work well in less extensive locations.

W 600/1

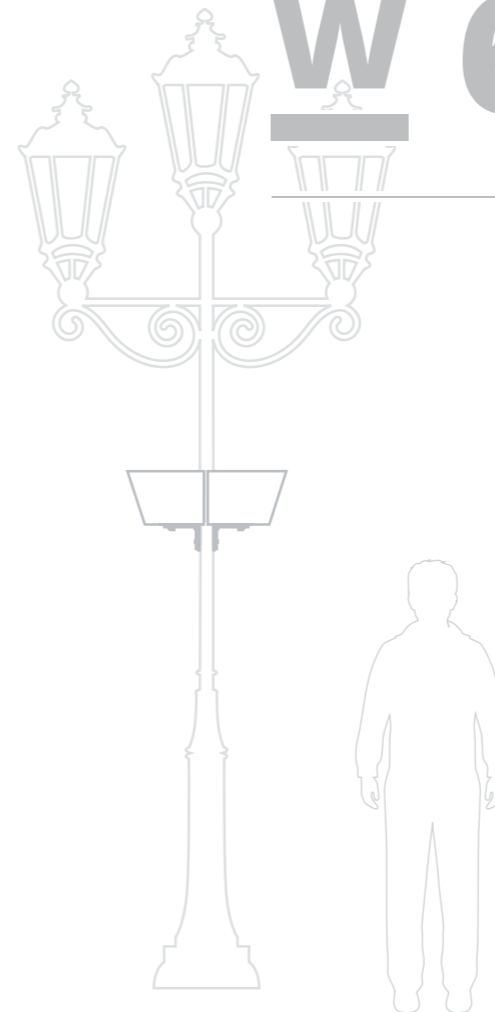

	Anzahl der Ringe levels	▶	1
	Fassungsvermögen capacity	▶	46 l
	Gesamthöhe total height	▶	220 mm
	Basisdurchmesser bottom diameter	▶	400 mm
	Gewicht vor Bepflanzung weight before planting	▶	2 x 6 kg
	Gewicht nach Bepflanzung weight after planting	▶	2 x 12-21 kg
	Anzahl der Setzlinge estimated number of plants	▶	2 x 5 - 7
	Basisfarbe basic colour	▶	4
	Farbvarianten available colours	▶	1 2 3

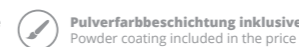
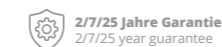

WENIGER IST MEHR
LESS IS MORE

www.blumentuerme.de

www.terra-flower-tower.com

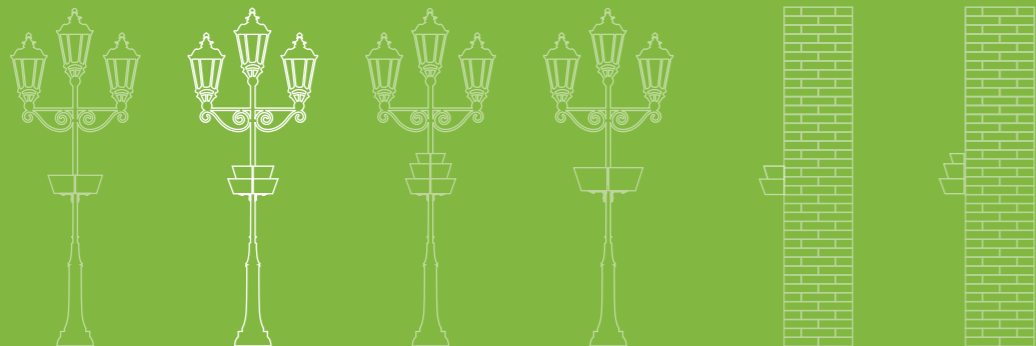

KASKADENKONSTRUKTION
FLOWER TOWER

W 600/2

Diese hängende Blumenkaskade bietet den Platz für eine maximale Anzahl von Setzlingen. Es reichen 35 Jungpflanzen, um mit geringem Geldaufwand einen interessanten Effekt zu erreichen. Das ist eine bewährte Methode, um die Straßenlaternen zu bepflanzen – besonders auf kleineren Flächen, wo traditionelle Anpflanzungen unmöglich sind.

You can put many seedlings in the small space of this hanging Flower Tower. Even 35 young plants allow you to obtain a satisfactory visual effect, and with less financial expenditure. It is an effective tool for decorating street lamps, especially in less extensive spaces without any substrate.

☰ 2 levels

🏠 2 x 16-35 kg

💧 58 l

⚡ 330 mm

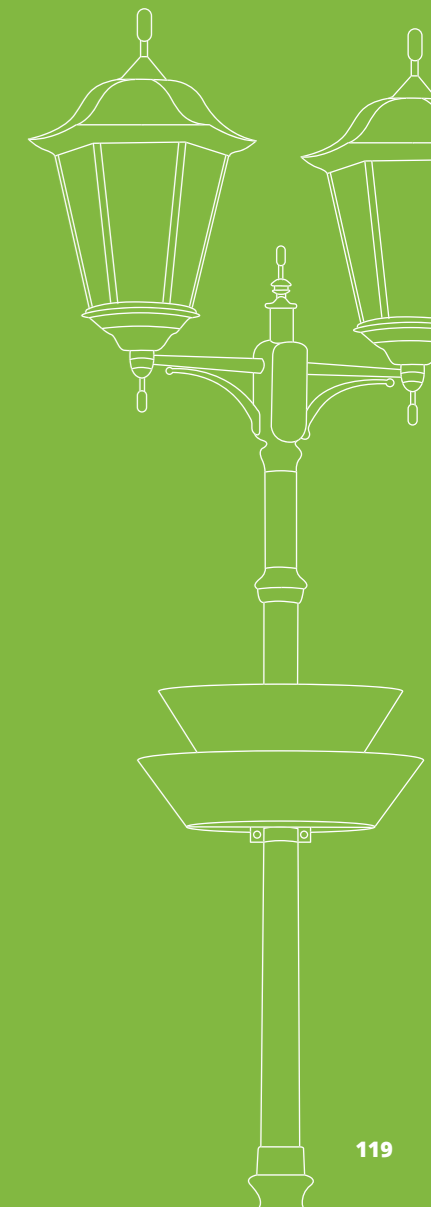



PASSAGE

Das ist in der Regel eine schmale Stelle zum Durchgehen oder ein pulsierender Ort mit Geschäften. An solchen Orten bewähren sich ideal hängende Blumenampeln, die in einer Linie montiert sind. Stehende Dekorationen, die ähnlich bepflanzt werden, vervollständigen das Image der Gegend.

THE ARCADE

The arcade is most often a passage between buildings, it is a lively place with shops and service points. There are plenty of them all over Poland! In such locations suspended flower containers, mounted in one line on street lamps, will work great. The standing decorations, with a similar set of flowers, will complete the image of the area.

W 600/2

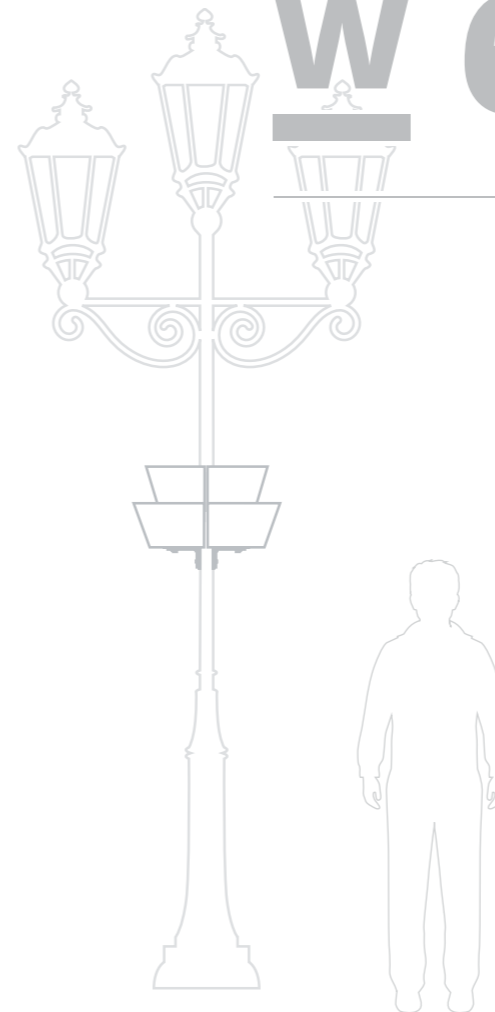

	Anzahl der Ringe levels	▶	2
	Fassungsvermögen capacity	▶	58 l
	Gesamthöhe total height	▶	330 mm
	Basisdurchmesser bottom diameter	▶	400 mm
	Gewicht vor Bepflanzung weight before planting	▶	2 x 7 kg
	Gewicht nach Bepflanzung weight after planting	▶	2 x 16-35 kg
	Anzahl der Setzlinge estimated number of plants	▶	2 x 8-12
	Basisfarbe basic colour	▶	4
	Farbvarianten available colours	▶	1 2 3

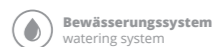
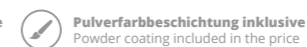
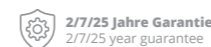

EFFEKT EINER BLUMIGEN KUGEL
THE FLOWER BALL EFFECT

www.blumentuerme.de

www.terra-flower-tower.com

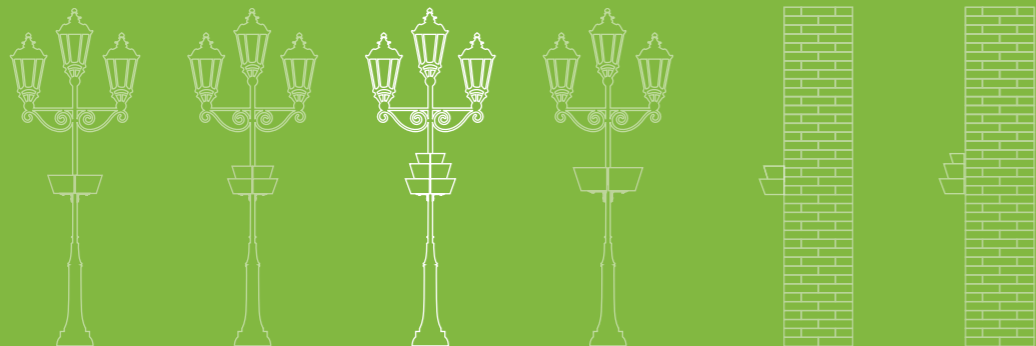

KASKADENKONSTRUKTION
FLOWER TOWER

W 600/3

Dank innovativem Kaskadensystem mit doppeltem Boden sowie der Pulverfarbschicht unterscheiden sich diese Konstruktionen von anderen Blumenampeln. Verschiedene Befestigungsarten ermöglichen die Anpassung des Modells W600/3 an jede Straßenlaterne. Im Endeffekt entsteht eine einzigartige, blumige Kugel.

The innovative system of the Flower Tower with a double bottom and painting in the standard version distinguish it from other lamp decorations. Additionally, various types of fixings make W600 / 3 suitable for all types of street lamps. The result of this unique patented hanging Flower Tower system is a flower ball effect.

☰ 3 levels

🏠 2 x 22-45 kg

💧 70 l

⚡ 475 mm

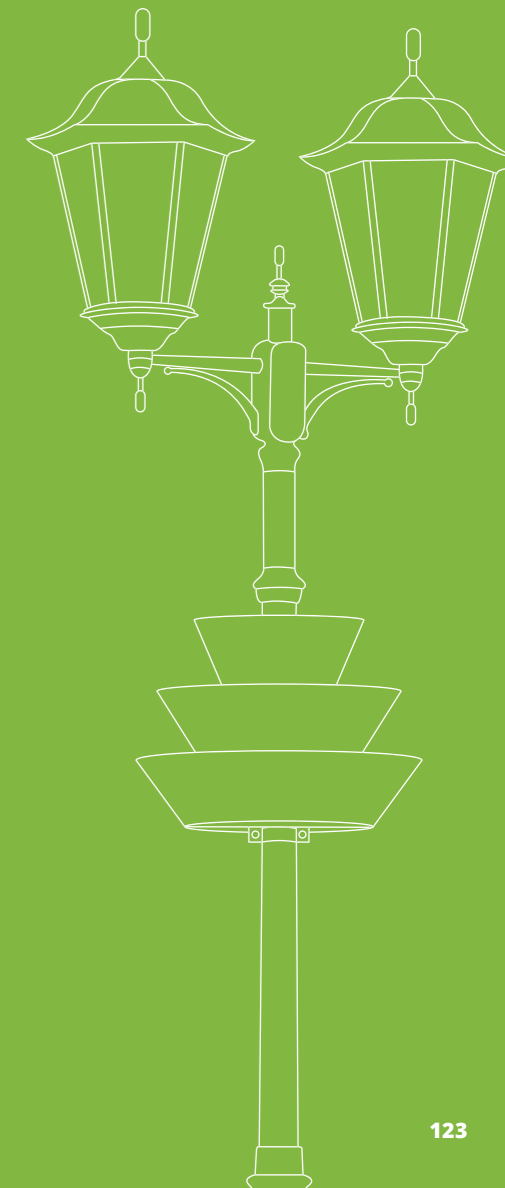



PLATZ IN DER STADTMITTE

In jeder Stadt befinden sich zahlreiche Grünanlage, die man auf verschiedene Art und Weise arrangieren kann. Wenn Sie den Platz auf dem Bürgersteig sparen wollen, verwenden Sie als Basis der Dekoration die Straßenlaternen. Betonnen Sie ihre Schönheit mit blumigen Kaskadenkonstruktionen W600/3 schaffen können.

THE SQUARE IN THE CENTRE

The heart of many Polish cities is a paved square. Such a large surface, devoid of natural ground, is a challenge! Its monotony can be effectively overcome by using floral decorations. If you don't want to take up space on the sidewalk, use street lamps. Emphasize them with floral balls created by Hanging Flower Towers W600/3.

W 600/3



	Anzahl der Ringe levels	▶	3
	Fassungsvermögen capacity	▶	70 l
	Gesamthöhe total height	▶	475 mm
	Basisdurchmesser bottom diameter	▶	400 mm
	Gewicht vor Bepflanzung weight before planting	▶	2 x 9 kg
	Gewicht nach Bepflanzung weight after planting	▶	2 x 22-45 kg
	Anzahl der Setzlinge estimated number of plants	▶	2 x 10-14
	Basisfarbe basic colour	▶	4
	Farbvarianten available colours	▶	1 2 3

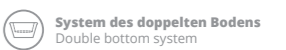
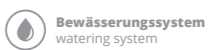
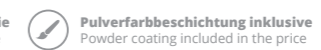
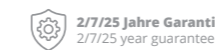
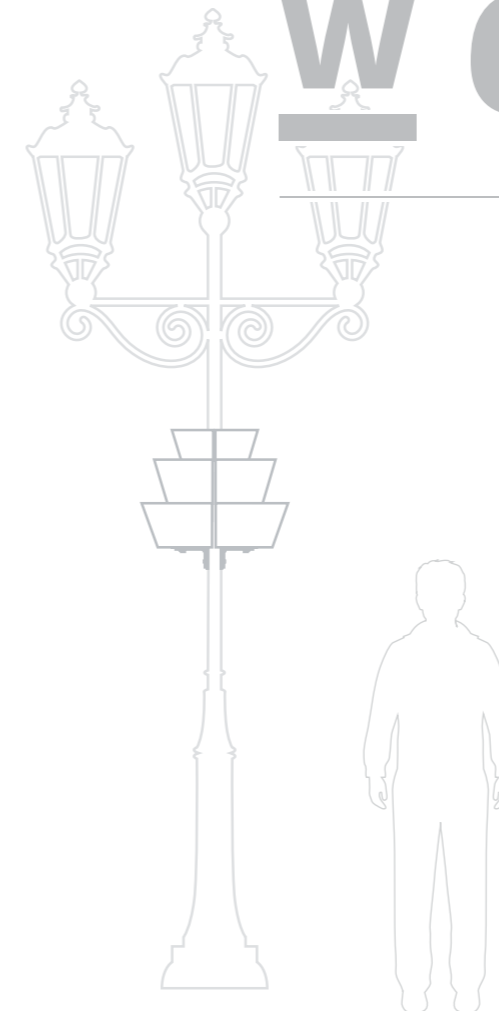

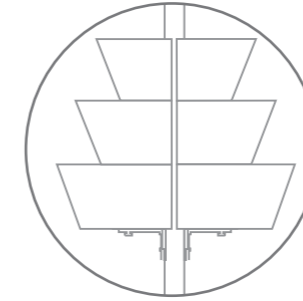

► BEFESTIGUNGEN FÜR JEDE ART DER STRASSENLATERNEN

SUITABLE FIXINGS FOR ANY STREET LAMP

Breite Befestigungspalette ermöglicht die Montage der Blumenampel an fast jede Straßenlaterne. Dank der speziellen Konstruktion sind hängende Dekorationen eine sichere Lösung, die Ästhetik des Raumes verbessern lässt.

Hanging Flower Towers have a wide range of fixings, so they can be easily placed on almost any street lamp. A carefully designed construction makes the decorations a safe solution that effectively improves the aesthetics of the space.

With a head in flowers...

Spezielles Befestigungssystem lässt die Blumenampeln an beliebige Straßenlaternen mit verschiedenen Formen und Größen montieren. Es garantiert die Sicherheit und schützt die Außenschicht der Laternen.

The advanced mounting system guarantees that the hanging containers can go on any street lamp, regardless of its shape and size. The use of dedicated fixings guarantees safety of use and protection of the lamp surface.

Weronika Wojciechowska

Sales Office Assistant | +48 68 455 62 69 | veronika.wojciechowska@terra-pl.eu





NOCH MEHR BLUMEN
EVEN MORE FLOWERS

www.blumentuerme.de

www.terra-flower-tower.com

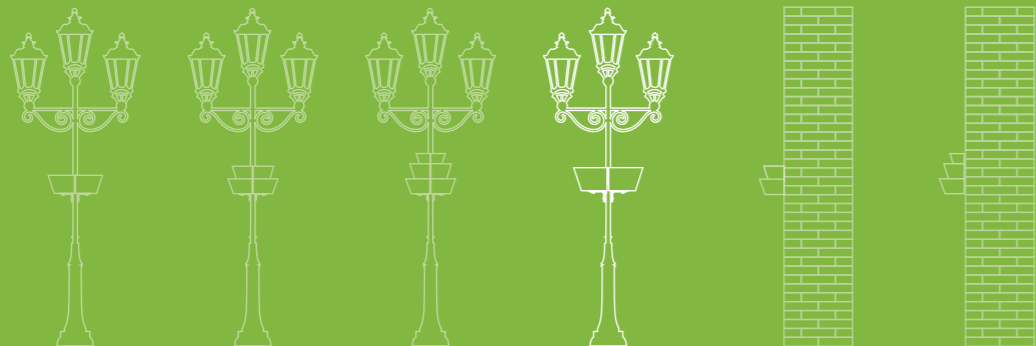

NEW

KASKADENKONSTRUKTION
FLOWER TOWER

W 800/1

Das neueste Modell der hängenden Kaskadenkonstruktion, welches speziell für repräsentative Räume geschaffen wurde. Diese geräumige Blumenschale ermöglicht die Einführung von bis zu zwanzig Setzlingen auf einmal. Das ist eine ideale Lösung für Straßenlaternen und Masten auf repräsentativen Plätzen.

The latest model of the hanging Flower Tower, which was created to meet the challenges of the most prestigious spaces. This capacious flower bowl gives possibility to bring up to twenty seedlings at the same time - an ideal solution for street lamps and poles on representative squares.

☰ 1 level

🏠 2 x 18-42 kg

💧 75 l

⚡ 270 mm

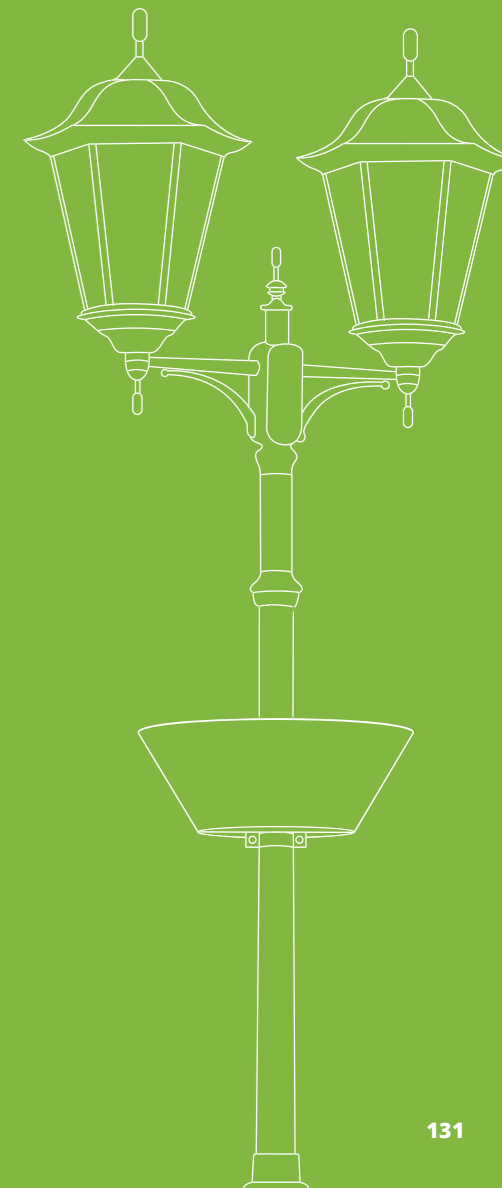



PLATZ VOR DEM MIETSHAUS

Besonderer Effekt für einen repräsentativen Raum! Hängende Blumenampel W800/1 betont die unmittelbare Umgebung der repräsentativen Gebäude. Sie garantiert eine so erfolgreiche, beeindruckende Wirkung, dass sie sich vor den Museen, Rathäusern oder anderen öffentlichen Gebäuden perfekt bewährt.

THE SQUARE IN FRONT OF THE TENEMENT HOUSE

A prestigious place - prestigious decorations! The hanging Flower Tower W800/1 will add splendor to the immediate vicinity of representative buildings. It guarantees so marvellous effect that it will effectively emphasize the doors of museums, town halls and other public buildings.

W 800/1

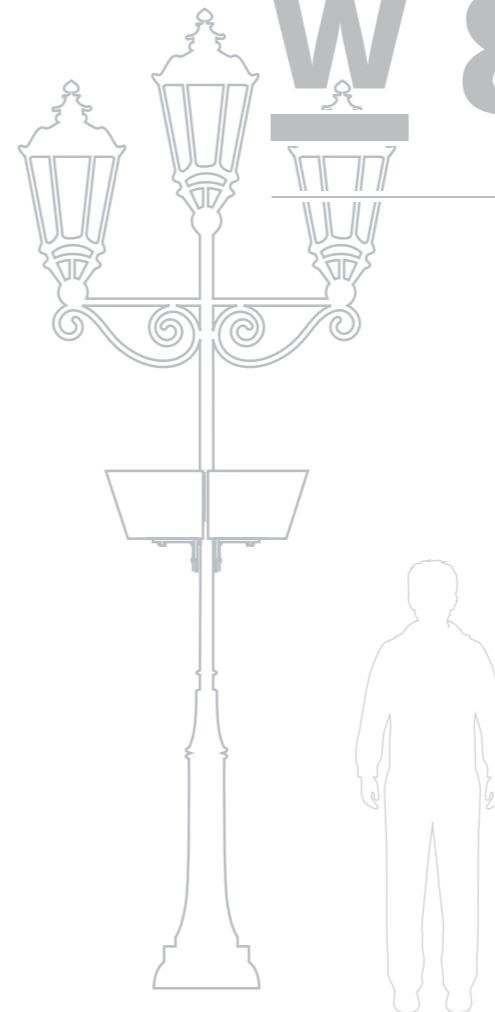

	Anzahl der Ringe levels	▶	1
	Fassungsvermögen capacity	▶	75 l
	Gesamthöhe total height	▶	270 mm
	Basisdurchmesser bottom diameter	▶	490 mm
	Gewicht vor Bepflanzung weight before planting	▶	2 x 11 kg
	Gewicht nach Bepflanzung weight after planting	▶	2 x 18-42 kg
	Anzahl der Setzlinge estimated number of plants	▶	2 x 8-10
	Basisfarbe basic colour	▶	4
	Farbvarianten available colours	▶	1 2 3

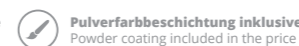
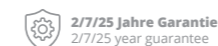



MASSGESCHNEIDERTE LÖSUNG
A TAILOR-MADE SOLUTION

www.blumentuerme.de

www.terra-flower-tower.com

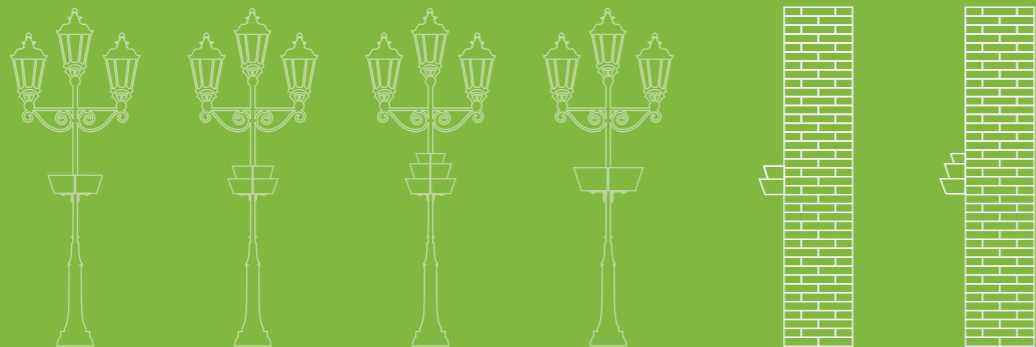

NEW

KASKADENKONSTRUKTION
FLOWER TOWER

W 600/2/3^{1/2}

Die halbkreisförmige Blumenampel ist der neueste Vorschlag aus der breiten Palette von Blumentürmen. Diese kompakte Dekoration mit solider Befestigung kann an Fassaden montiert werden. Mit bis zu 14 Setzlingen kann man leicht eine wirklich beeindruckende Komposition schaffen. Diese Lösung bewährt sich besonders gut dort, wo die Bepflanzung der Gehwege oder Straßenlaternen unmöglich ist.

The half model of a hanging Flower Tower is the latest one among numerous Flower Towers. This compact, solidly mounted decoration can be installed on facades. By planting up to 14 seedlings in it, you can easily get a really effective composition. This solution is recommended for places where it is impossible to decorate sidewalks or street lamps.

W 600/2^{1/2}

≡ 2 levels  16 - 35 kg  29 l  330 mm

W 600/3^{1/2}

≡ 3 levels  22 - 45 kg  35 l  475 mm





FASSADE DER STADTBIBLIOTHEK

Öffentliche Gebäude sind nicht nur Rathäuser oder Ämter. Bei der Gestaltung der blumigen Kompositionen lohnt es sich, auch die Stadtbibliotheken zu berücksichtigen. Ihre Fassaden sind ein großartiger Ort für hängende, halbkreisförmige Kaskadenkonstruktionen - auf diese Weise wird das gesamte Gebäude noch attraktiver.

THE FACADE OF THE CITY LIBRARY

Public buildings are not only town halls and district authority offices. When arranging a floral setting, it is also worth taking care of municipal libraries. Their facades are a great place for ½ hanging Flower Towers - in this way the entire building will seem even more attractive and worth visiting.

NEW

W 600/2 ^{1/2}

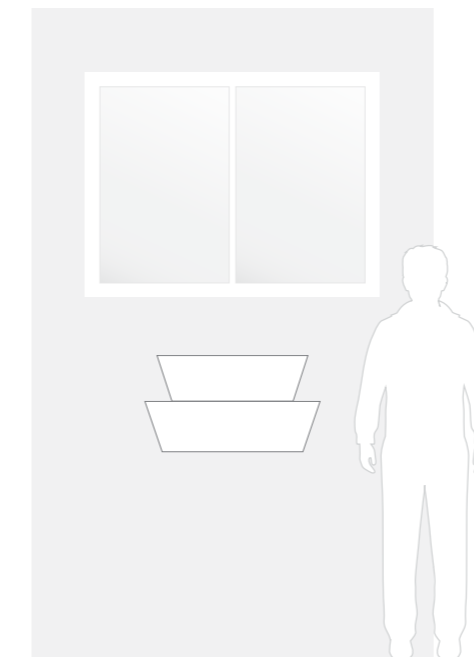

Vorderansicht
Front view

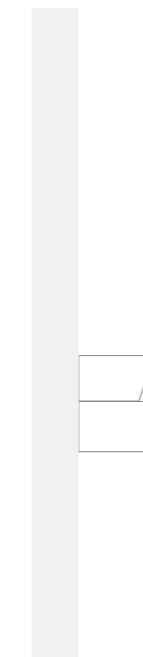

Seitenansicht
Side view

	Anzahl der Ringe levels	▶	2
	Fassungsvermögen capacity	▶	29 l
	Gesamthöhe total height	▶	330 mm
	Basisdurchmesser bottom diameter	▶	400 mm
	Gewicht vor Bepflanzung weight before planting	▶	7 kg
	Gewicht nach Bepflanzung weight after planting	▶	16-35 kg
	Anzahl der Setzlinge estimated number of plants	▶	8-12
	Basisfarbe basic colour	▶	4
	Farbvarianten available colours	▶	1 2 3

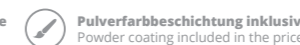
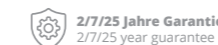



FASSADE DES RATHAUSES

Vor den Rathäusern gibt es in der Regel wunderschöne Blumendekorationen. Und was wäre, wenn auch ihre Fassaden blühen würden? Eine halbkreisförmige, dreistufige Blumenampel wird zu einer interessanten Fortsetzung für stehende Kaskadenkonstruktionen, wodurch die gesamte Komposition kohärenter und harmonischer wird.

THE FACADE OF THE TOWN HALL

There are usually some floral decorations in front of town halls. What if their facades were also decorated? An extensive, three-level hanging Flower Tower with a half structure will become an interesting continuation for the standing elements, making the whole composition more coherent and harmonious.

NEW

W 600/3 ^{1/2}

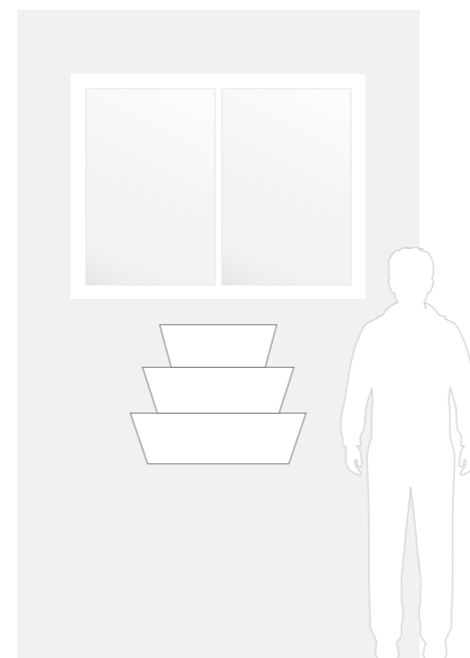

Vorderansicht
Front view

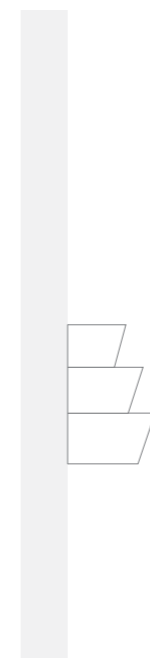

Seitenansicht
Side view

	Anzahl der Ringe levels	▶	3
	Fassungsvermögen capacity	▶	35 l
	Gesamthöhe total height	▶	475 mm
	Basisdurchmesser bottom diameter	▶	400 mm
	Gewicht vor Bepflanzung weight before planting	▶	9 kg
	Gewicht nach Bepflanzung weight after planting	▶	22-45 kg
	Anzahl der Setzlinge estimated number of plants	▶	10-14
	Basisfarbe basic colour	▶	4
	Farbvarianten available colours	▶	1 2 3

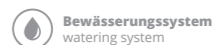
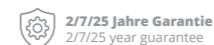



Kaufen Sie keine Katze im Sack



Bestellen Sie eine kostenlose Visualisierung und schauen Sie sich an, wie sich Ihre Stadt ändern kann.

Wir wissen, wie schwer das entsprechende Arrangement des Stadtraumes ist. Um Ihre Arbeit zu erleichtern, schlagen wir Ihnen eine kostenlose Visualisierung vor. Unsere Ideen helfen Ihnen bei der Wahl der Produkte und der Bepflanzung.

Schicken Sie uns per visualisation@terraflowertower.eu die Fotos der Orte, die Sie verändern möchten. Unsere Landschaftsarchitekten finden optimale Lösungen für Ihren Raum und schaffen eine kostenlose Visualisierung. Im Endeffekt bekommen Sie ein komplexes Projekt, dank dessen Sie sich das Ausmaß der geplanten Änderungen anschauen. Die Entscheidung liegt bei Ihnen!

Piotr Skubiszewski

Landschaftsarchitekt / Landscape architect
+48 68 455 62 69 | piotr.skubiszewski@terra-uk.eu



Don't buy sight unseen

Order a free visualisation and see how your city could change.

We know how hard is to prepare an urban space arrangement that will be outstanding and interesting. We want to make your work easier, so we offer you a free visualisation of changes in given places. Prepared projects and ideas facilitate the later selection of products and flowers..

Send the photos of places you want to change to us on visualisation@terraflowertower.eu. Our landscape architects will suggest you the best solutions and create an individual project. The result of our work will be the brand new design of your city. Now it's time for you decision...

Paulina Buczyńska

Graphic Designer
+48 669 200 020 | paulina.buczynska@terra-pl.eu



Stilvolles Weihnachtsambiente

Bereiten Sie Ihre Stadt auf Weihnachten vor

Im Sommer schmücken die Blumentürme viele Städte. Mit dem Ende der warmen Tage beginnt ihr Charme jedoch zu verblassen. Sie können sich aber auch im Winter als Dekoration der öffentlichen Plätze bewahren. Eine Lösung dafür sind die Terra-Weihnachtsüberzüge. Einerseits verschönern sie die Umgebung, andererseits lösen sie das Problem der Lagerung der Konstruktionen in der Winterzeit.



HOHE WIDERSTANDSFÄHIGKEIT

Dank der Feuerverzinkung sind die Weihnachtsüberzüge gegen niedrige Temperatur und Feuchtigkeit beständig.



HÖCHSTE QUALITÄT

Hochwertige Materialien, die zur Herstellung des Weihnachtsüberzuges verwendet wurden, gewährleisten eine lange Lebensdauer des Produktes.



EINFACHE MONTAGE

Der modulare Aufbau erleichtert die Montage und die Lagerung des Weihnachtsüberzuges.



HALTBAR UND STABIL

Die Befestigung an der Kaskade garantiert Stabilität des Überzuges und schützt vor dem Diebstahl.

Weronika Filipek

Key Account Specialist
+49 30 12 07 46 90
weronika.filipek@terra-de.eu

Terra[®]
Christmas

www.terrachristmas.de



Terra Christmas Tree

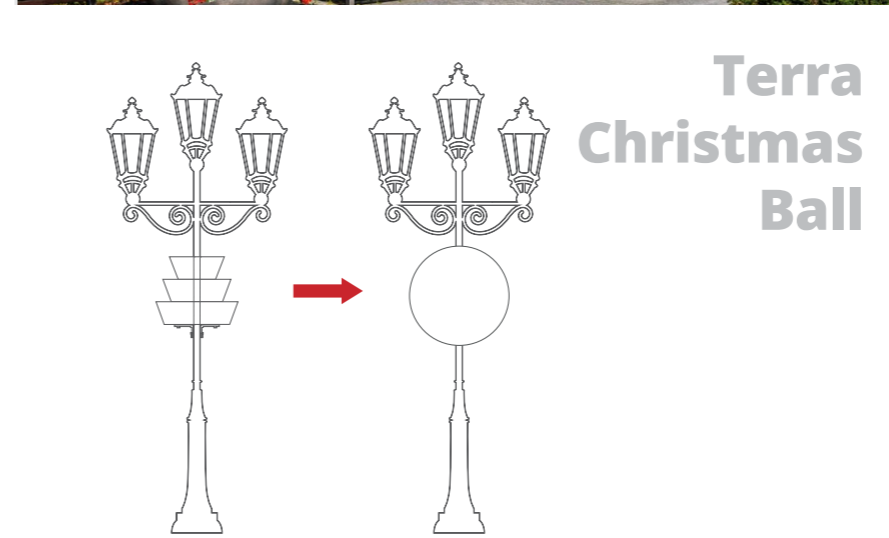
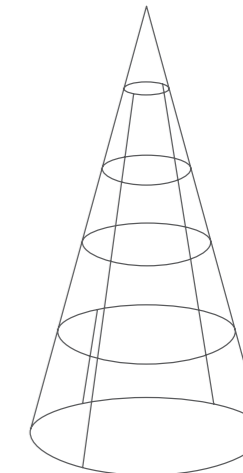
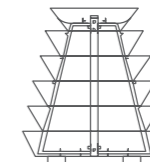

Terra Christmas Ball

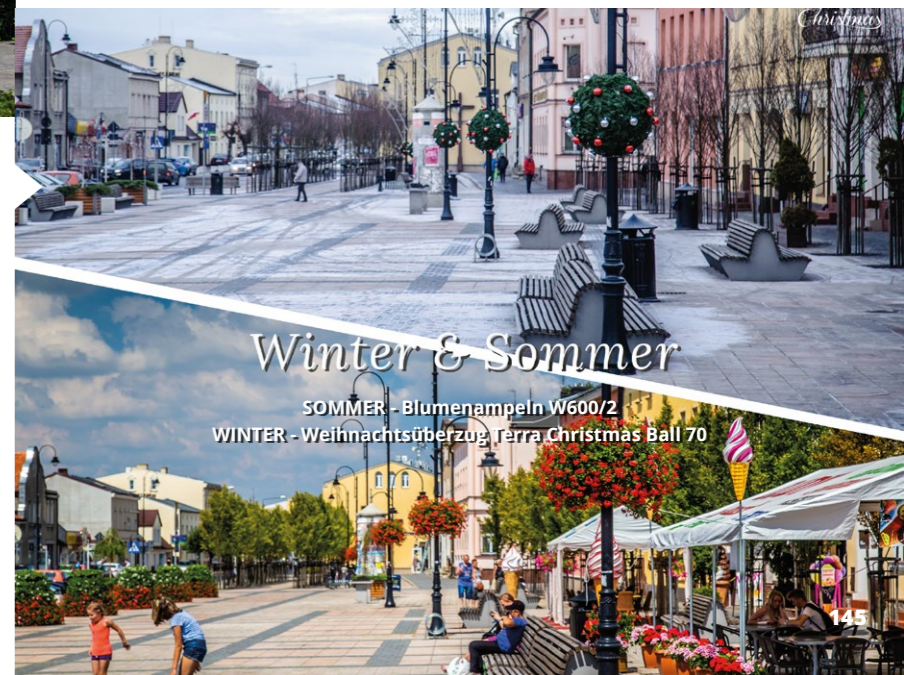
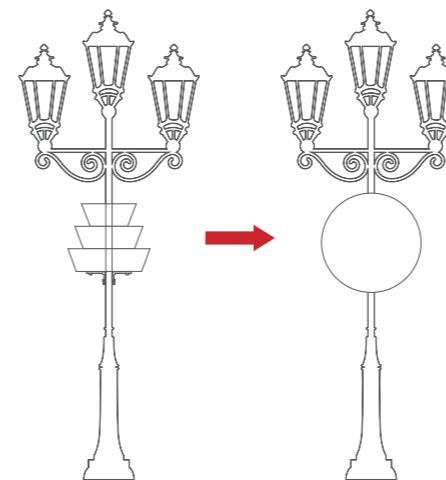

Christmas atmosphere

Get the city ready for Christmas

In summer, the Flower Towers decorate the cities, but at the end of warm days their charm begins to fade. However, there is nothing to prevent them from decorating city squares also in winter. If you want to bring the Christmas mood to your residents and decorate the Flower Towers, it is worth using the Terra Christmas covers. They will make the surroundings beautiful and modern, and at the same time eliminate the problem of arranging the Flower Towers in winter.



HIGH RESISTANCE

The highest quality hot-dip galvanized coating makes the covers resistant to low temperatures and moisture.



THE HIGHEST QUALITY

The highest quality materials used for the production of the cover ensure a long product life.



EASY INSTALLATION

The modular design facilitates the assembly and storage of the cover.



STRONG AND STABLE

Fixing to the structure ensures stability and protects against theft.

Katarzyna Bąba

Key Account Specialist
+48 68 455 62 69
katarzyna.baba@terra-uk.eu

Terra
Christmas

www.terrachristmas.com



Winter & Summer

SUMMER - Flower Towers H1200
WINTER - Terra Christmas Tree 300 Covers

Terra Christmas Tree

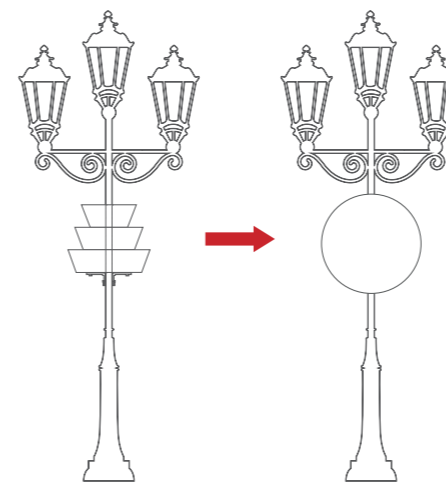
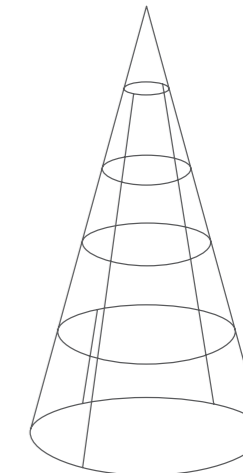
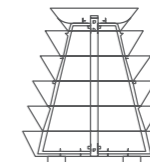















Terra Christmas Ball



Winter & Summer















SUMMER - Hanging Flower Towers W600/2
WINTER - Terra Christmas Ball 70 Cover

s.14 H 700

-  **Anzahl der Ringe**
levels ▶ 3
-  **Fassungsvermögen**
capacity ▶ 167 l
-  **Gesamthöhe**
total height ▶ 720 mm
-  **Basisdurchmesser**
bottom diameter ▶ 750 mm
-  **Gewicht vor Bepflanzung**
weight before planting ▶ 35 kg
-  **Gewicht nach Bepflanzung**
weight after planting ▶ 105 - 160 kg
-  **Anzahl der Setzlinge**
estimated number of plants ▶ 30 - 40
-  **Basisfarbe**
basic colour ▶  5
-  **Farbvarianten**
available colours ▶  1  2
 3  4







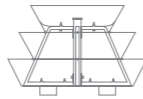





s.22 H 750

-  **Anzahl der Ringe**
levels ▶ 3
-  **Fassungsvermögen**
capacity ▶ 373 l
-  **Gesamthöhe**
total height ▶ 740 mm
-  **Basisdurchmesser**
bottom diameter ▶ 1200 mm
-  **Gewicht vor Bepflanzung**
weight before planting ▶ 58 kg
-  **Gewicht nach Bepflanzung**
weight after planting ▶ 190 - 370 kg
-  **Anzahl der Setzlinge**
estimated number of plants ▶ 40 - 50
-  **Basisfarbe**
basic colour ▶  5
-  **Farbvarianten**
available colours ▶  1  2
 3  4







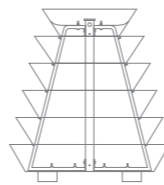







s.46 H 1200

-  **Anzahl der Ringe**
levels ▶ 6
-  **Fassungsvermögen**
capacity ▶ 668 l
-  **Gesamthöhe**
total height ▶ 1355 mm
-  **Basisdurchmesser**
bottom diameter ▶ 1200 mm
-  **Gewicht vor Bepflanzung**
weight before planting ▶ 86 kg
-  **Gewicht nach Bepflanzung**
weight after planting ▶ 355 - 660 kg
-  **Anzahl der Setzlinge**
estimated number of plants ▶ 72 - 90
-  **Basisfarbe**
basic colour ▶  5
-  **Farbvarianten**
available colours ▶  1  2
 3  4











s.56 H 1200 1/2

-  **Anzahl der Ringe**
levels ▶ 6
-  **Fassungsvermögen**
capacity ▶ 314 l
-  **Gesamthöhe**
total height ▶ 1355 mm
-  **Basisdurchmesser**
bottom diameter ▶ 1/2 1200 mm
-  **Gewicht vor Bepflanzung**
weight before planting ▶ 60 kg
-  **Gewicht nach Bepflanzung**
weight after planting ▶ 180 - 300 kg
-  **Anzahl der Setzlinge**
estimated number of plants ▶ 40 - 50
-  **Basisfarbe**
basic colour ▶  5
-  **Farbvarianten**
available colours ▶  1  2
 3  4



s.30 H 1100

-  **Anzahl der Ringe**
levels ▶ 6
-  **Fassungsvermögen**
capacity ▶ 125 l
-  **Gesamthöhe**
total height ▶ 1010 mm
-  **Basisdurchmesser**
bottom diameter ▶ 600 mm
-  **Gewicht vor Bepflanzung**
weight before planting ▶ 30 kg
-  **Gewicht nach Bepflanzung**
weight after planting ▶ 90 - 120 kg
-  **Anzahl der Setzlinge**
estimated number of plants ▶ 32 - 50
-  **Basisfarbe**
basic colour ▶  5
-  **Farbvarianten**
available colours ▶  1  2
 3  4

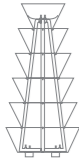

s.38 H 1150/750

-  **Anzahl der Ringe**
levels ▶ 6
-  **Fassungsvermögen**
capacity ▶ 275 l
-  **Gesamthöhe**
total height ▶ 1190 mm
-  **Basisdurchmesser**
bottom diameter ▶ 750 mm
-  **Gewicht vor Bepflanzung**
weight before planting ▶ 53 kg
-  **Gewicht nach Bepflanzung**
weight after planting ▶ 160 - 230 kg
-  **Anzahl der Setzlinge**
estimated number of plants ▶ 50 - 70
-  **Basisfarbe**
basic colour ▶  5
-  **Farbvarianten**
available colours ▶  1  2
 3  4

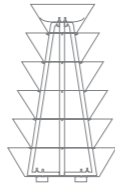

s.56 H 1200 1/4

-  **Anzahl der Ringe**
levels ▶ 6
-  **Fassungsvermögen**
capacity ▶ 157 l
-  **Gesamthöhe**
total height ▶ 1335 mm
-  **Basisdurchmesser**
bottom diameter ▶ 1/4 1200 mm
-  **Gewicht vor Bepflanzung**
weight before planting ▶ 17 kg
-  **Gewicht nach Bepflanzung**
weight after planting ▶ 96 - 150 kg
-  **Anzahl der Setzlinge**
estimated number of plants ▶ 20 - 25
-  **Basisfarbe**
basic colour ▶  5
-  **Farbvarianten**
available colours ▶  1  2
 3  4











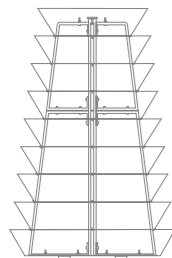





s.56 H 1200 1/2 ROUND

-  **Anzahl der Ringe**
levels ▶ 6
-  **Fassungsvermögen**
capacity ▶ 307 l
-  **Gesamthöhe**
total height ▶ 1355 mm
-  **Basisdurchmesser**
bottom diameter ▶ 1/2 1200 mm
-  **Gewicht vor Bepflanzung**
weight before planting ▶ 60 kg
-  **Gewicht nach Bepflanzung**
weight after planting ▶ 180 - 300 kg
-  **Anzahl der Setzlinge**
estimated number of plants ▶ 40 - 50
-  **Basisfarbe**
basic colour ▶  5
-  **Farbvarianten**
available colours ▶  1  2
 3  4

















s.68 **H 2000**



-  **Anzahl der Ringe**
levels ▶ 9
-  **Fassungsvermögen**
capacity ▶ 1168 l
-  **Gesamthöhe**
total height ▶ 1990 mm
-  **Basisdurchmesser**
bottom diameter ▶ 1200 mm
-  **Gewicht vor Bepflanzung**
weight before planting ▶ 124 kg
-  **Gewicht nach Bepflanzung**
weight after planting ▶ 600 - 1150 kg
-  **Anzahl der Setzlinge**
estimated number of plants ▶ 110 - 130
-  **Basisfarbe**
basic colour ▶  5
-  **Farbvarianten**
available colours ▶  1  2
 3  4

s.76 **H 2000** ^{1/2}



-  **Anzahl der Ringe**
levels ▶ 9
-  **Fassungsvermögen**
capacity ▶ 584 l
-  **Gesamthöhe**
total height ▶ 1990 mm
-  **Basisdurchmesser**
bottom diameter ▶ ½ 1200 mm
-  **Gewicht vor Bepflanzung**
weight before planting ▶ 62 kg
-  **Gewicht nach Bepflanzung**
weight after planting ▶ 300 - 575 kg
-  **Anzahl der Setzlinge**
estimated number of plants ▶ 55 - 65
-  **Basisfarbe**
basic colour ▶  5
-  **Farbvarianten**
available colours ▶  1  2
 3  4

s.86 **H 3000**



-  **Anzahl der Ringe**
levels ▶ 15
-  **Fassungsvermögen**
capacity ▶ 1390 l
-  **Gesamthöhe**
total height ▶ 3105 mm
-  **Basisdurchmesser**
bottom diameter ▶ 1200 mm
-  **Gewicht vor Bepflanzung**
weight before planting ▶ 175 kg
-  **Gewicht nach Bepflanzung**
weight after planting ▶ 1400 - 1600 kg
-  **Anzahl der Setzlinge**
estimated number of plants ▶ 165 - 215
-  **Basisfarbe**
basic colour ▶  5
-  **Farbvarianten**
available colours ▶  1  2
 3  4

s.94 **H 3400**

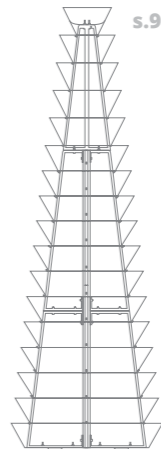

-  **Anzahl der Ringe**
levels ▶ 17
-  **Fassungsvermögen**
capacity ▶ 1490 l
-  **Gesamthöhe**
total height ▶ 3435 mm
-  **Basisdurchmesser**
bottom diameter ▶ 1200 mm
-  **Gewicht vor Bepflanzung**
weight before planting ▶ 190 kg
-  **Gewicht nach Bepflanzung**
weight after planting ▶ 1800 - 2000 kg
-  **Anzahl der Setzlinge**
estimated number of plants ▶ 185 - 230
-  **Basisfarbe**
basic colour ▶  5
-  **Farbvarianten**
available colours ▶  1  2
 3  4

H 2400 ^{1/2}



-  **Anzahl der Ringe**
levels ▶ 12
-  **Fassungsvermögen**
capacity ▶ 667 l
-  **Gesamthöhe**
total height ▶ 2610 mm
-  **Basisdurchmesser**
bottom diameter ▶ ½ 1200 mm
-  **Gewicht vor Bepflanzung**
weight before planting ▶ 103 kg
-  **Gewicht nach Bepflanzung**
weight after planting ▶ 355 - 650 kg
-  **Anzahl der Setzlinge**
estimated number of plants ▶ 80 - 100
-  **Basisfarbe**
basic colour ▶  5
-  **Farbvarianten**
available colours ▶  1  2
 3  4

s.78 **H 2400**



-  **Anzahl der Ringe**
levels ▶ 12
-  **Fassungsvermögen**
capacity ▶ 1335 l
-  **Gesamthöhe**
total height ▶ 2610 mm
-  **Basisdurchmesser**
bottom diameter ▶ 1200 mm
-  **Gewicht vor Bepflanzung**
weight before planting ▶ 147 kg
-  **Gewicht nach Bepflanzung**
weight after planting ▶ 710 - 1300 kg
-  **Anzahl der Setzlinge**
estimated number of plants ▶ 145 - 180
-  **Basisfarbe**
basic colour ▶  5
-  **Farbvarianten**
available colours ▶  1  2
 3  4

s.114 **W 600/1**

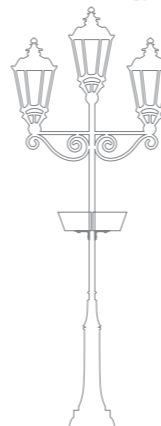

-  **Anzahl der Ringe**
levels ▶ 1
-  **Fassungsvermögen**
capacity ▶ 46 l
-  **Gesamthöhe**
total height ▶ 220 mm
-  **Basisdurchmesser**
bottom diameter ▶ 400 mm
-  **Gewicht vor Bepflanzung**
weight before planting ▶ 2 x 6 kg
-  **Gewicht nach Bepflanzung**
weight after planting ▶ 2 x 12 - 21kg
-  **Anzahl der Setzlinge**
estimated number of plants ▶ 2 x 5 - 7
-  **Basisfarbe**
basic colour ▶  5
-  **Farbvarianten**
available colours ▶  1  2
 3  4



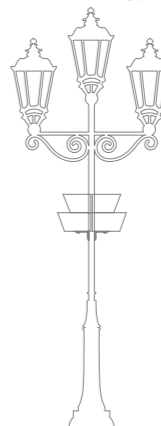







s.118 **W 600/2**



-  **Anzahl der Ringe**
levels ▶ 2
-  **Fassungsvermögen**
capacity ▶ 58 l
-  **Gesamthöhe**
total height ▶ 330 mm
-  **Basisdurchmesser**
bottom diameter ▶ 400 mm
-  **Gewicht vor Bepflanzung**
weight before planting ▶ 2 x 7 kg
-  **Gewicht nach Bepflanzung**
weight after planting ▶ 2 x 16 - 35 kg
-  **Anzahl der Setzlinge**
estimated number of plants ▶ 2 x 8 - 12
-  **Basisfarbe**
basic colour ▶  5
-  **Farbvarianten**
available colours ▶  1  2
 3  4

s.122 **W 600/3**

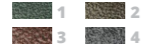

-  **Anzahl der Ringe**
levels ▶ 3
-  **Fassungsvermögen**
capacity ▶ 70 l
-  **Gesamthöhe**
total height ▶ 475 mm
-  **Basisdurchmesser**
bottom diameter ▶ 400 mm
-  **Gewicht vor Bepflanzung**
weight before planting ▶ 2 x 9 kg
-  **Gewicht nach Bepflanzung**
weight after planting ▶ 2 x 22 - 45 kg
-  **Anzahl der Setzlinge**
estimated number of plants ▶ 2 x 10 - 14
-  **Basisfarbe**
basic colour ▶ 
-  **Farbvarianten**
available colours ▶ 









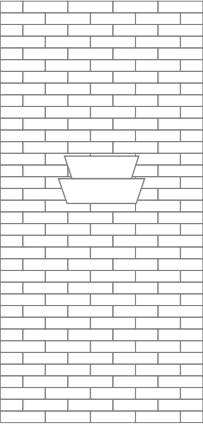

s.130 **W 800/1** **NEW**



-  **Anzahl der Ringe**
levels ▶ 1
-  **Fassungsvermögen**
capacity ▶ 75 l
-  **Gesamthöhe**
total height ▶ 275 mm
-  **Basisdurchmesser**
bottom diameter ▶ 490 mm
-  **Gewicht vor Bepflanzung**
weight before planting ▶ 2 x 11 kg
-  **Gewicht nach Bepflanzung**
weight after planting ▶ 2 x 18 - 42 kg
-  **Anzahl der Setzlinge**
estimated number of plants ▶ 2 x 8 - 10
-  **Basisfarbe**
basic colour ▶ 
-  **Farbvarianten**
available colours ▶ 





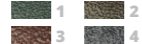



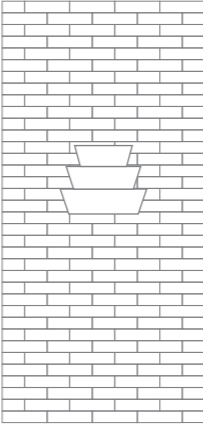

s.136 **W 600/2** **1/2** **NEW**



-  **Anzahl der Ringe**
levels ▶ 2
-  **Fassungsvermögen**
capacity ▶ 29 l
-  **Gesamthöhe**
total height ▶ 330 mm
-  **Basisdurchmesser**
bottom diameter ▶ 400 mm
-  **Gewicht vor Bepflanzung**
weight before planting ▶ 7 kg
-  **Gewicht nach Bepflanzung**
weight after planting ▶ 16 - 35 kg
-  **Anzahl der Setzlinge**
estimated number of plants ▶ 8 - 12
-  **Basisfarbe**
basic colour ▶ 
-  **Farbvarianten**
available colours ▶ 

s.136 **W 600/3** **1/2** **NEW**

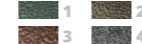

-  **Anzahl der Ringe**
levels ▶ 3
-  **Fassungsvermögen**
capacity ▶ 70 l
-  **Gesamthöhe**
total height ▶ 550 mm
-  **Basisdurchmesser**
bottom diameter ▶ 600 mm
-  **Gewicht vor Bepflanzung**
weight before planting ▶ 17 kg
-  **Gewicht nach Bepflanzung**
weight after planting ▶ 45 - 90 kg
-  **Anzahl der Setzlinge**
estimated number of plants ▶ 20 - 30
-  **Basisfarbe**
basic colour ▶ 
-  **Farbvarianten**
available colours ▶ 



Dort wo die Natur nicht reicht... | www.blumentuerme.de

Where nature doesn't reach... | www.terra-flower-tower.com



Unser Markenportfolio
Brands Terra Group



Unser Markenportfolio
Brands Terra Group



Terra[®]
Group

*TerraKaskaden - Marke von Terra Group
Terra Flower Towers - a brand of Terra Group*

Terra Group

*Gemeinsam sorgen wir für eine
noch schönere Zukunft!*

Mahlsdorfer Straße 61B
15366 Hoppegarten
bei Berlin

T: +49 (0) 30.12 07 46 90
F: +49 (0) 30.12 07 46 909
E: info@terra-de.eu

www.terra-de.eu

www.tblumentuerme.de

Terra Group

*create more
beautiful tomorrow!*

ul. Gen. Józefa Sowińskiego 42a
65-419 Zielona Góra

T: +48 68 455 62 69
F.: +48 68 414 54 25

E: info@terra-uk.eu
www.terra-uk.eu

www.terra-flower-tower.com