

TYPES OF RACKS

Triangle Stand for 3 Eggs

Application:
ground with the
possibility of fixing

Compatibility:
1x T75, 1xT100, 1xT120

Standard Color:
black

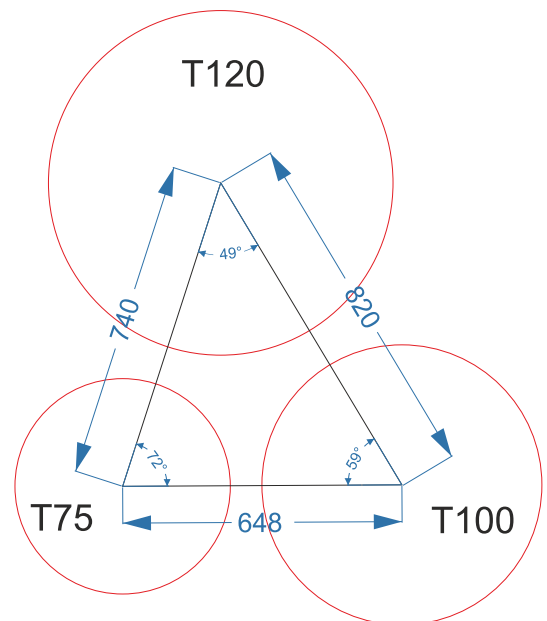
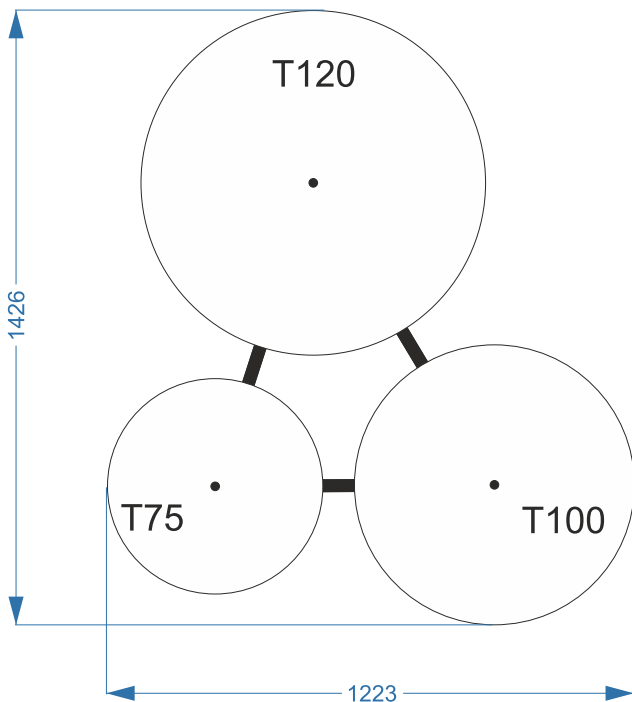
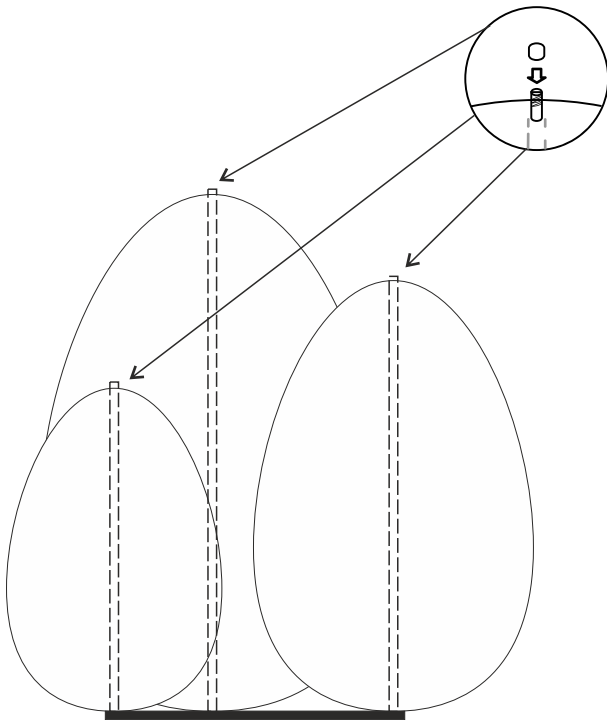
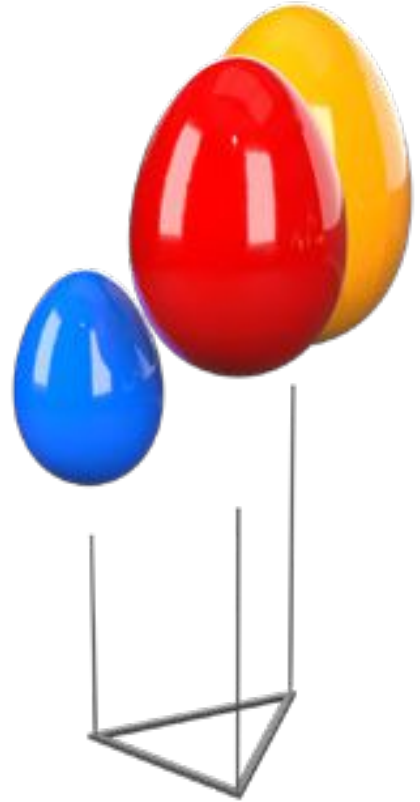

TYPES OF RACKS

Rack Square for 4 Eggs

Application:
ground with the
possibility of fixing

Compatibility:
2x T75, 1xT100, 1xT120

Standard Color:
black

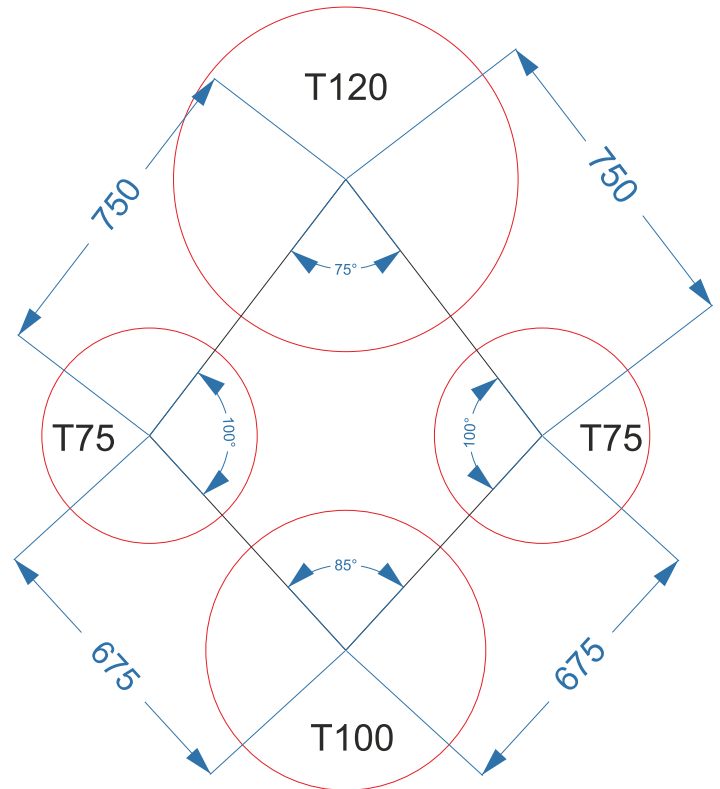
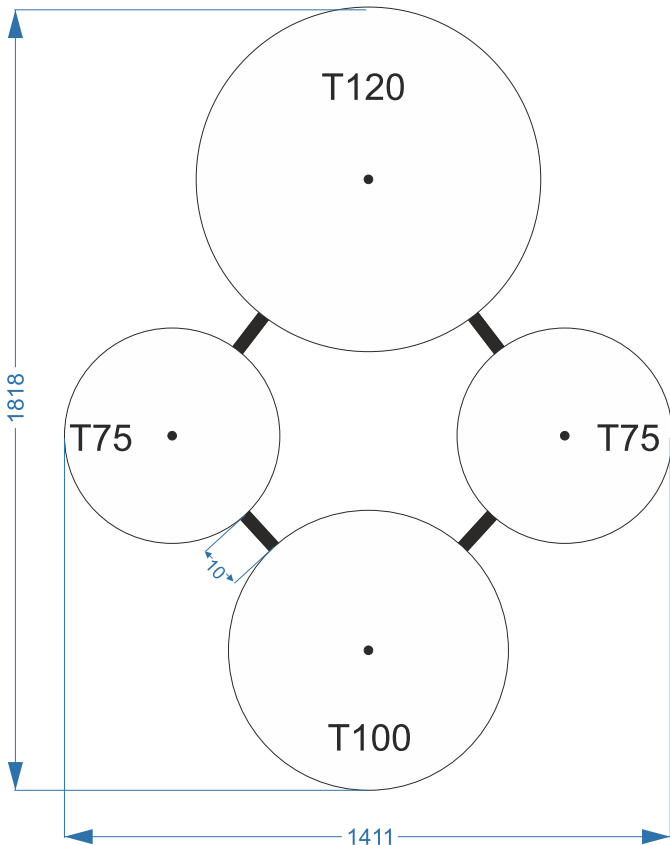
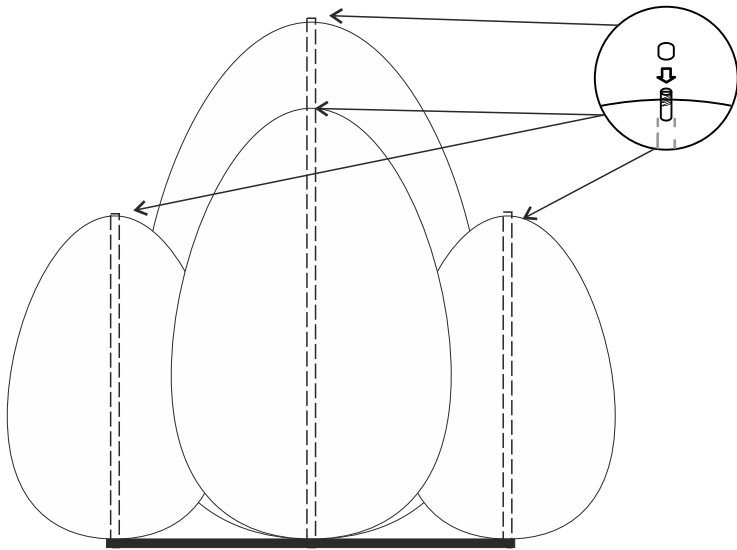

TYPES OF RACKS

Rack Square for 5 Eggs

Application:
ground with the
possibility of fixing

Compatibility:
5xT100

Standard Color:
black

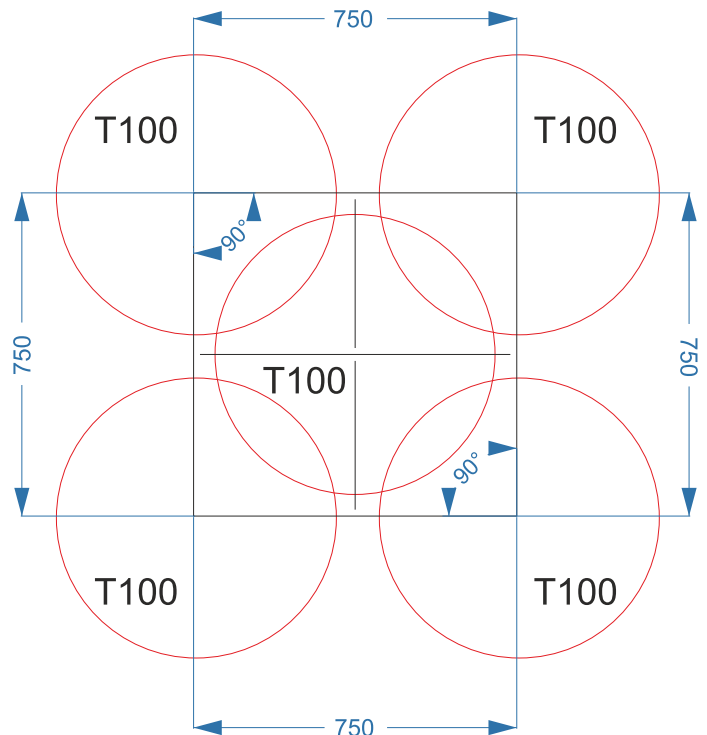
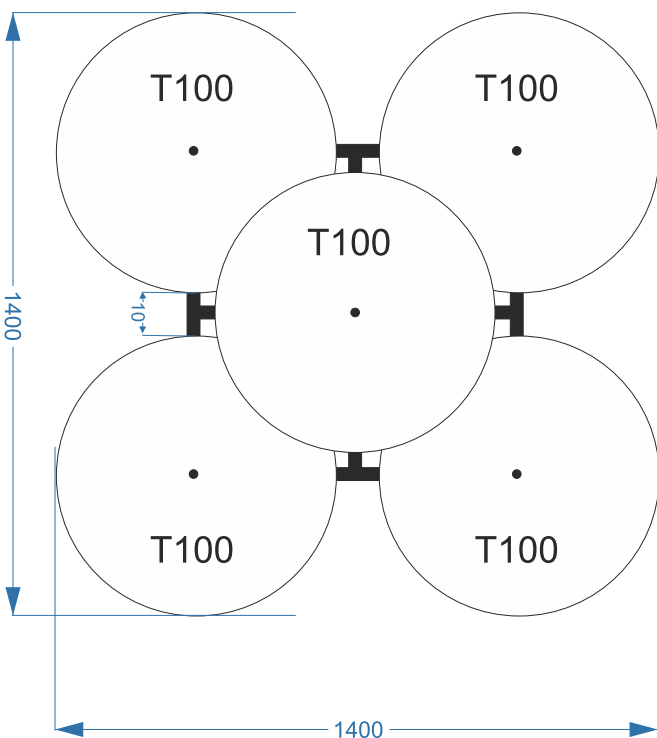
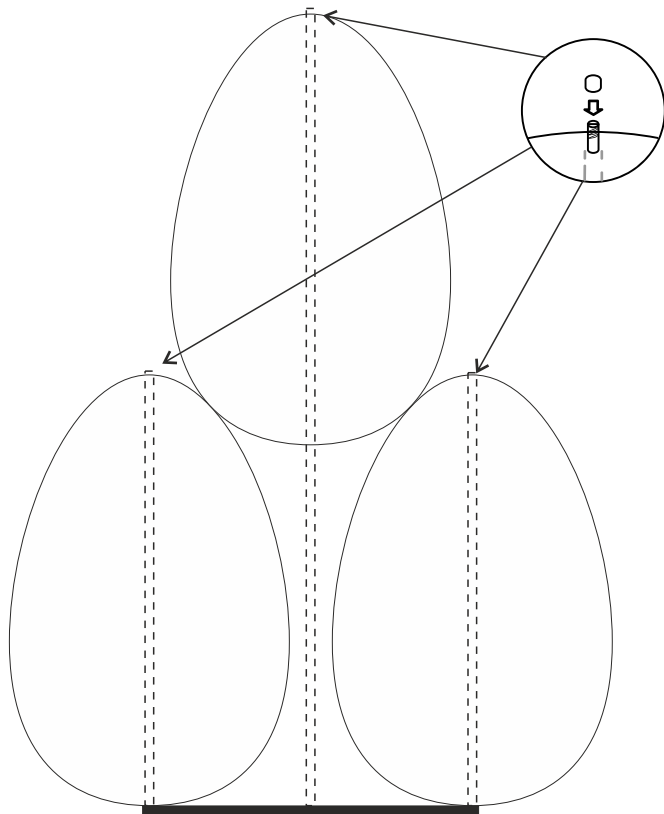

TYPES OF RACKS

Rack „C+”

Application:
ground with the
possibility of fixing

Compatibility:
1x T75, 2xT30
1xT100, 2xT30

Standard Color:
black

