

TeraPlast™
italian beauty



PLANT YOUR VISION

CATALOGUE / CATALOGO 2023

INDEX
INDICE

INTRO / INTRO2

ELEMENTS.....13

COLOUR.....29

CLEAR45

ESSENTIAL55

TRAMA.....73

CHIC79

BOLD89

EVER103

TOOLS / ATTREZZI 117

SAUCERS / SOTTOVASI 121

ACCESSORIES / ACCESSORI 125



Follow us on our social media / Seguici sui nostri social media



WWW.TERAPLAST.COM

ABOUT / CHI SIAMO

Teraplast is a solid reality in pots panorama, which has been present for years all over the world to enrich with green public spaces, premises and private homes.

In our company tradition and innovation are united by an indissoluble bond.

Our **experience in plastic moulding**, combined with our desire to improve our products and user experience through **training, analysis** and **constant research**, allow us to identify new trends and respond to emerging needs.



Teraplast è una solida realtà nel panorama dei vasi, da anni presente in ogni parte del mondo per arricchire con il verde spazi pubblici, locali e abitazioni private.

Nella nostra realtà aziendale tradizione e innovazione sono uniti da un legame indissolubile.

La nostra **esperienza** nello **stampaggio della plastica**, unita alla volontà di migliorare i nostri prodotti e le esperienze di utilizzo attraverso **formazione, analisi** e una **ricerca costante**, ci permettono di individuare le nuove tendenze e di rispondere alle necessità emergenti.

PLANT YOUR VISION

We are manufacturers of plant pots. As such, we rely on **state-of-the-art technology** and the skill and **expertise** of our departmental staff, who are constantly striving to perfect our work.

The introduction of various innovations, including **new all-electric molding machines**, help us to **reduce environmental impact** while maintaining high levels of product quality and durability. All this because we aim to satisfy green enthusiasts by offering products that last and can be transformed into new resources at the end of their lives.



Siamo produttori di vasi per piante. Come tali ci avvaliamo di **tecnologie d'avanguardia** e della manualità e **professionalità** del nostro personale di reparto, risorse fondamentali impegnate costantemente per perfezionare il nostro lavoro.

L'introduzione di diverse innovazioni, tra cui le nuove **presse totalmente elettriche**, ci aiutano a **ridurre l'impatto ambientale** mantenendo alti i livelli di qualità e resistenza dei prodotti.

Tutto questo perchè miriamo a soddisfare gli appassionati del verde offrendo articoli che **durino nel tempo** e che, a fine vita, possano essere trasformati in **nuove risorse**.

OUR MISSION / LA NOSTRA MISSIONE

We translate the actions we take into concrete results.

Certifications help us to demonstrate the quality of our products, to recognise our commitment to sustainability and to identify the traceability of the raw materials we use.

White certificates or Energy Savings Certificates (ESC) attest to the achievement of savings in the final use of energy, **"Plastics Second Life"** identifies goods made of recycled plastics, **ISO 9001** recognizes the quality, effectiveness and efficiency of our internal processes and **the Organizational Model D. Lgs. 231/2001** which regulates and defines the corporate structure and management of sensitive processes.

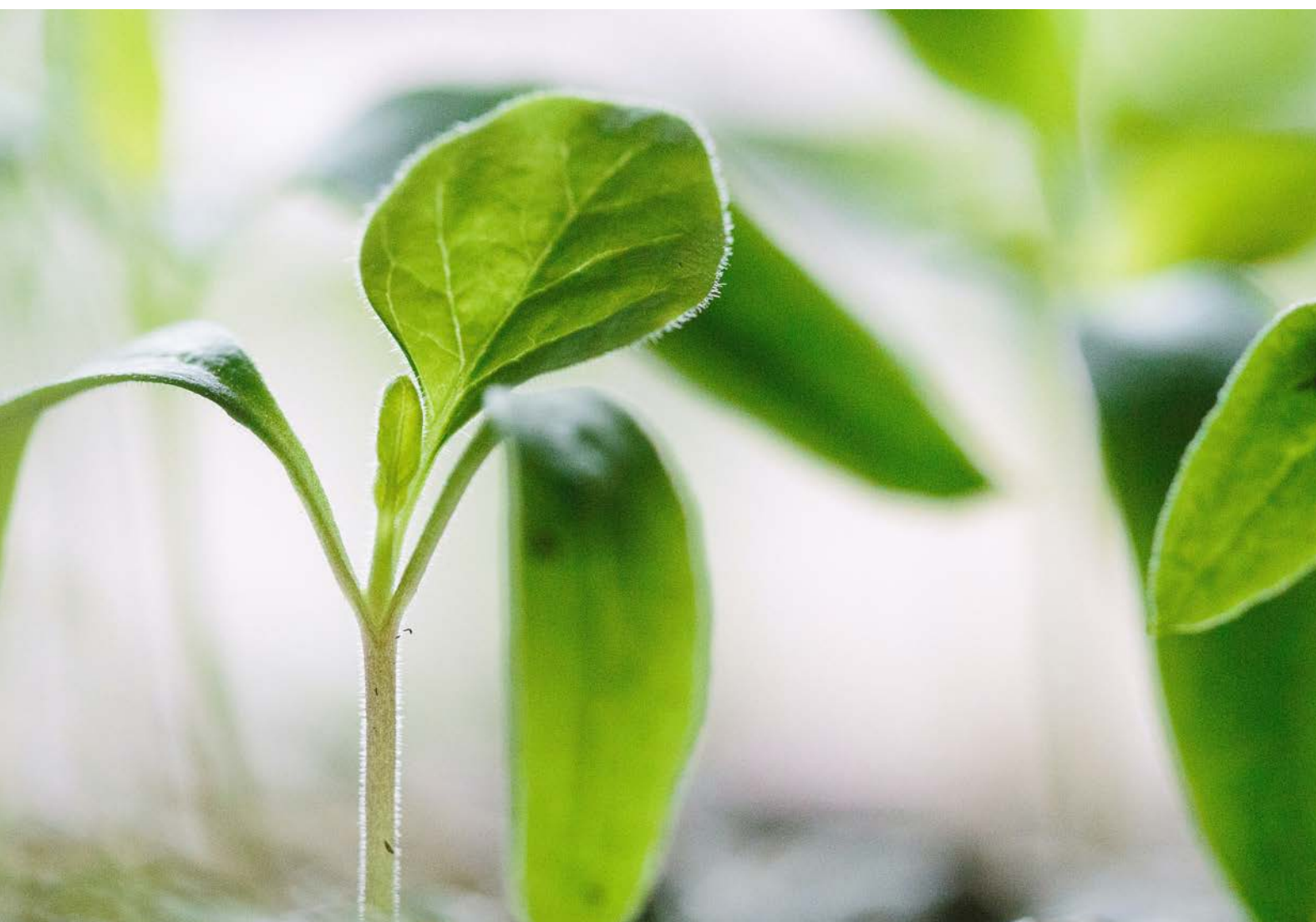

Traduciamo le azioni intraprese in risultati concreti.

Le certificazioni ci aiutano per dimostrare la qualità dei nostri prodotti, per riconoscere il nostro impegno in termini di sostenibilità e per identificare la tracciabilità delle materie prime che utilizziamo.

I certificati bianchi o Titoli di Efficienza Energetica (TEE) attestano il conseguimento di risparmi nell'utilizzo finale di energia, **"Plastica Seconda Vita"** identifica i beni realizzati in materie plastiche da riciclo, **ISO 9001** riconosce la qualità, l'efficacia e l'efficienza dei nostri processi interni e **il Modello Organizzativo D. Lgs. 231/2001** che regola e definisce la struttura aziendale e la gestione dei processi sensibili.

SERVICE / IL SERVIZIO

Teraplast is oriented towards **experimentation** and **research** beyond the limits of materials, technologies and shapes to create innovative and effective products and display solutions.

The production of a **wide range of articles** together with the design of display models allows us to **assist the customer** in a complete way with the aim of **improving performance** within the point of sale. We offer display solutions and communication tools designed to provide consumers with all the information they need to choose a product. A service aimed at enhancing and enriching the collaboration with our **partners** through constant dialogue and research.



Teraplast è orientata alla **sperimentazione** e alla **ricerca** al di là dei limiti dei materiali, delle tecnologie e delle forme, per arrivare a creare prodotti e soluzioni espositive innovativi ed efficaci.

La produzione di una **vasta gamma di articoli** assieme alla progettazione di modelli espositivi ci permette di **assistere il cliente** in maniera completa con l'obiettivo di **migliorare le prestazioni** all'interno del punto vendita. Offriamo soluzioni di allestimento e strumenti di comunicazione pensati per fornire al consumatore tutte le informazioni utili per la scelta del prodotto. Si tratta di un servizio volto a valorizzare ed arricchire la collaborazione con i nostri **partner** attraverso un dialogo e una ricerca costante.

tera[®]

 plastic
second life



**the new
raw-material
that comes
from waste**

*la nuova materia
che nasce
dal rifiuto urbano*

www.teraitaly.com



ALTÈRA

design made for you

NEW SPACE TO LIVE

From the study of everyday spaces comes the need of Teraplast S.p.A. to introduce a new line of furniture items to integrate complements in perfect balance with the environments, without relegating them to a marginal role.

The choice of shapes, colors and textures aims to demonstrate the versatility of products in different contexts, in order to enhance the space around us.

The experience of a solid company combined with the passion for innovation, the research for original and functional design, the curiosity for new possibilities and the interest in proposing diversified solutions, guided by superior aesthetics, have given birth to Altèra.

Dallo studio degli spazi del quotidiano nasce l'esigenza di Teraplast S.p.A. di introdurre una nuova linea di articoli di arredo per integrare complementi in perfetto equilibrio con gli ambienti, senza relegarli ad un ruolo marginale.

La scelta delle forme, dei colori e della texture vuole dimostrare la versatilità dei prodotti in contesti differenti, allo scopo di impreziosire lo spazio che ci circonda.

L'esperienza di un'azienda solida unita alla passione per l'innovazione, la ricerca per il design originale e funzionale, la curiosità verso nuove possibilità e l'interesse di proporre soluzioni diversificate, guidate da un'estetica superiore, hanno dato vita ad Altèra.



www.altera.design

NEWS
NOVITÁ

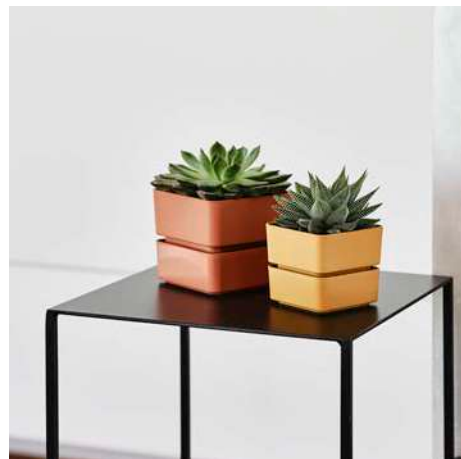

VELETA

Pg. 32



SIERRA

Pg. 33



VILA

Pg. 41



ARES

Pg. 93



EOS

Pg. 108



CIRCUM

Pg. 110



LITHOS & PETRAM

Pg. 90



TRAMA 01

Pg. 74



TRAMA 02

Pg. 75



TRAMA 03

Pg. 76

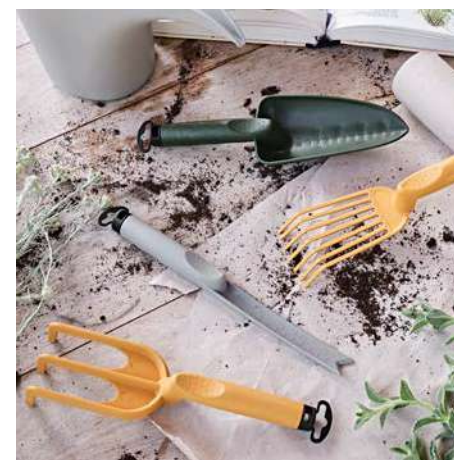

GAIA

Pg. 119



BELEM

Pg. 118



ELEMENTS

INJECTION / INIEZIONE

Lightness and resistance are characteristics present in every product of the Elements collection. The clean and modern style, the solidity and the remarkable capacity make the vase an article of inexhaustible functionality and simple style that never gets old.

Saucer included:

The functionality of these items is also defined by the included, interlocking saucer. This system is designed to collect excess water that will be transmitted to the plant by osmosis when it needs it again.

Leggerezza e resistenza sono caratteristiche presenti in ogni prodotto della collezione Elements. Lo stile pulito e moderno, la solidità e la notevole capienza rendono il vaso un articolo dalle funzionalità inesauribili e dallo stile semplice che non stanca mai.

Sottovaso incluso:

La funzionalità di questi articoli è definita anche grazie al sottovaso incluso e fissato ad incastro. Questo sistema è stato progettato per raccogliere l'acqua in eccesso che verrà trasmessa alla pianta per osmosi quando questa ne avrà nuovamente bisogno.



HYDRAL



more resistant
thanks to
the reinforced structure

piu' resistente
grazie alla
struttura rinforzata



Water diffusion through osmosis effect
-
Diffusione dell'acqua per osmosi

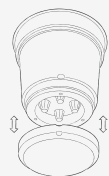

The saucer is included and is fitted into
-
Il sottovaso è incluso e viene fissato ad incastro



code without color codice senza colore	cm	cm	cm	L	min. q.ty q.tà min.
28 107 018	18	13	16	2,5	20
28 107 023	23	16	21	5	10
28 107 028	28	20	25	9	10
28 107 033	32,5	24	29,5	15	10
28 107 038	38	27	34	23	10
28 107 048	48	34	42,5	46,5	5
28 107 058	57,5	41	49	77	5
28 107 068	67,5	49	55	120	5
28 107 078	78	56	61	175,5	5

Colours

001	005	022	404	406	414	314
001	005	022	404	406	414	314
001	005	022	404	406	414	314
001	005	022	404	406	414	314
005	022		406	414		
005	022		406	414		
005	022		406	414		
005	022		406	414		

DISPLAY SOLUTIONS

SOLUZIONI ESPOSITIVE

The display in photo, for demonstration purposes only, contains:
L'espositore in foto, a puro titolo dimostrativo, contiene:

code without color codice senza colore	item description descrizione articolo	q.ty per color q.tà per colore			
		005	022	414	314
28 107 018	Hydral 18	5	5	5	5
28 107 023	Hydral 23	5	5	5	5
28 107 028	Hydral 28	5	5	5	5
28 107 033	Hydral 33	5	5	5	5
28 107 038	Hydral 38	5	5	5	5

For further information on display solutions, contact the sales team.
Per avere ulteriori informazioni sulle soluzioni espositive contattare la squadra commerciale.



IRON DISPLAY HYDRAL



KIT HYDRAL

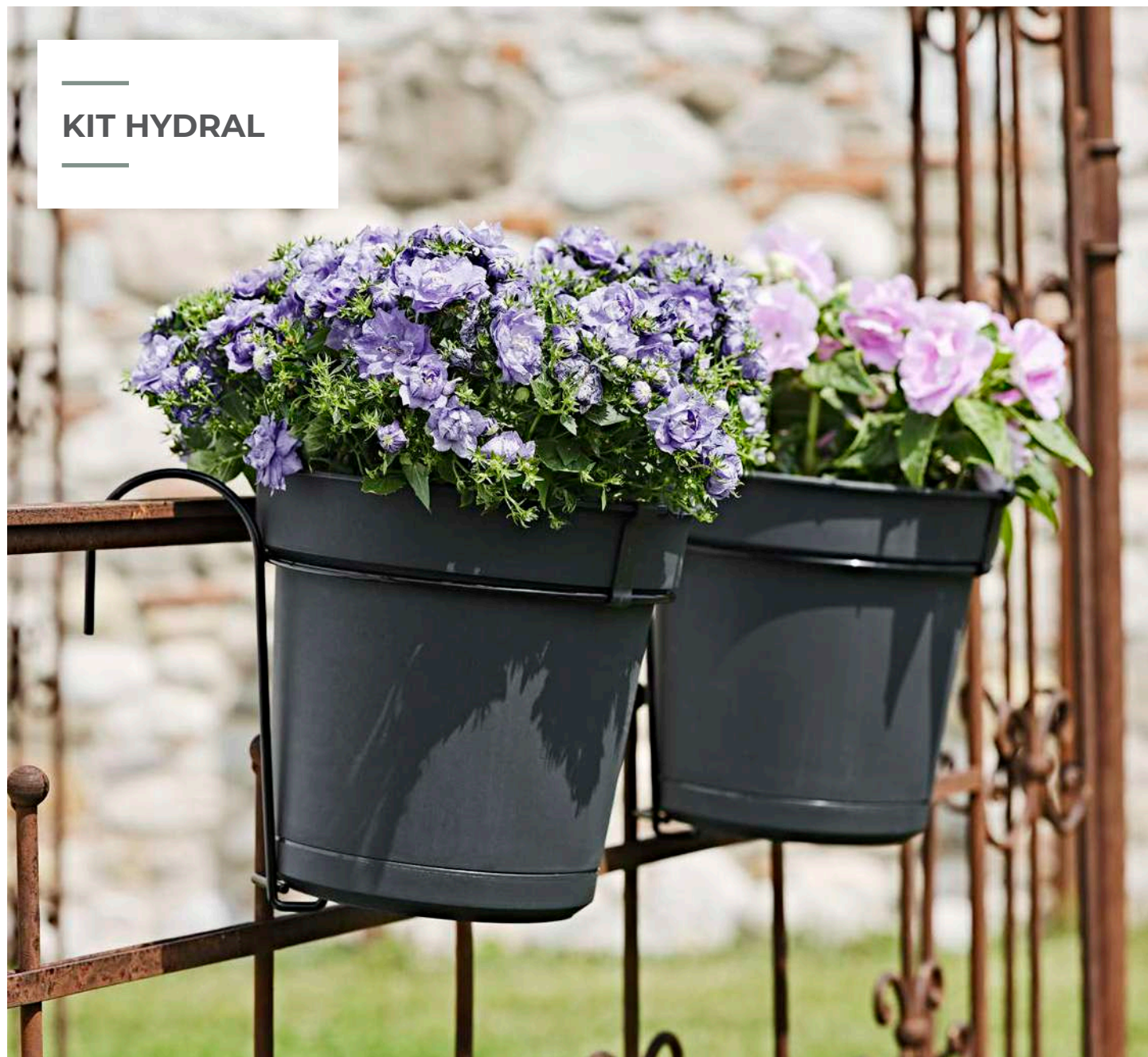

Water diffusion through osmosis effect
-
Diffusione dell'acqua per osmosi

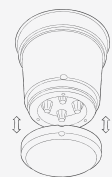

The saucer is included and is fitted into
-
Il sottovaso è incluso e viene fissato ad incastro



314 **001** **005** **022** **404** **406** **414**



code without color
codice senza colore



cm



cm



cm



L

min. q.ty
q.tà min.

28 130 023

23

27

22,5

5

15

AIR

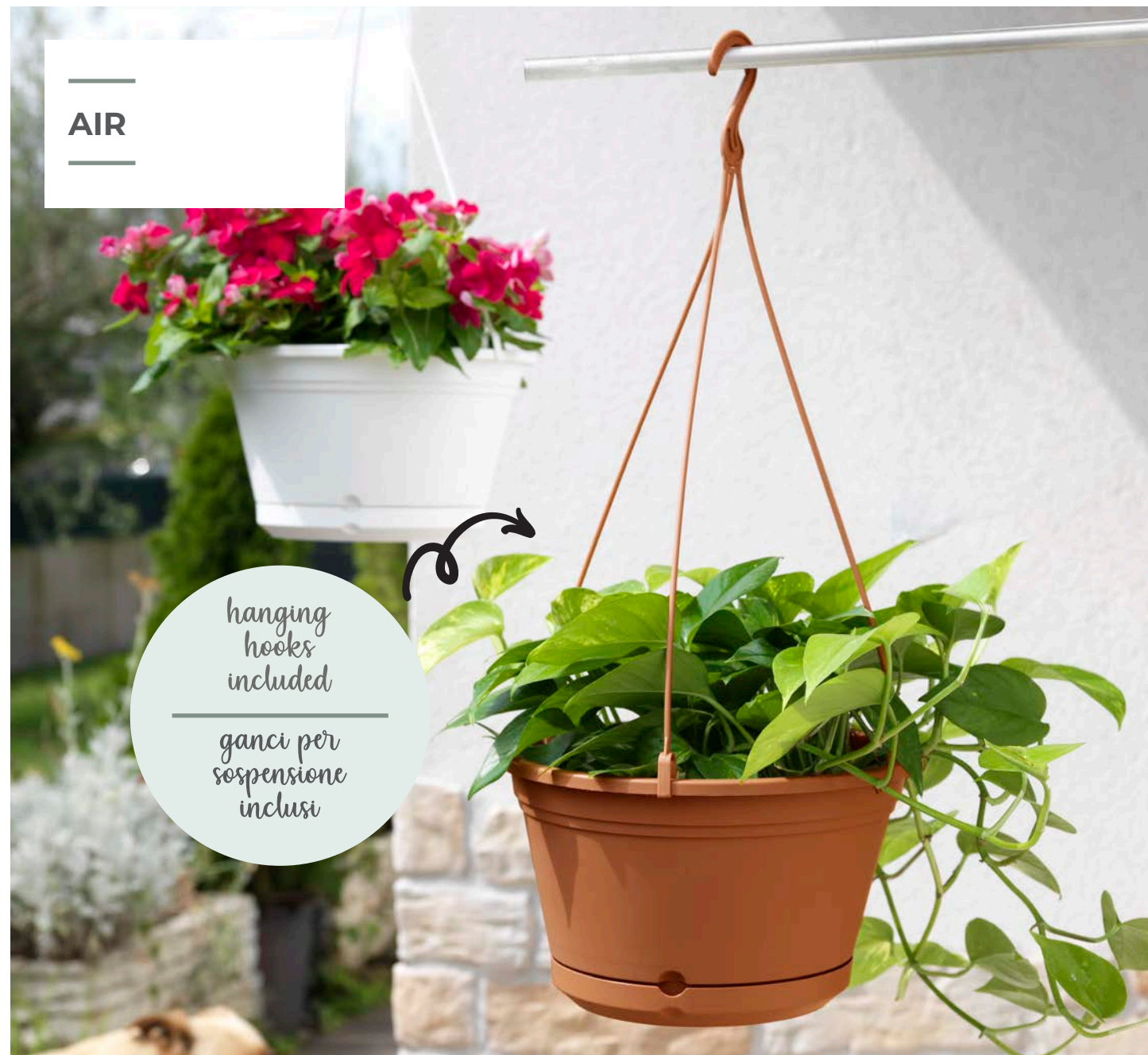

hanging
hooks
included

ganci per
sospensione
inclusi



Water diffusion through osmosis effect
-
Diffusione dell'acqua per osmosi



The saucer is included and is fitted into
-
Il sottovaso è incluso e viene fissato ad incastro



001 **005** **022** **406** **414**



code without color
codice senza colore



cm

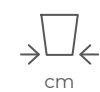

cm



cm



L

min. q.ty
q.tà min.

28 125 029

28,5

20

17

6,3

12

STILL



Water diffusion through osmosis effect
-
Diffusione dell'acqua per osmosi

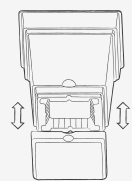

The saucer is included and is fitted into
-
Il sottovaso è incluso e viene fissato ad incastro



more resistant
thanks to the
reinforced structure

piu' resistente
grazie alla
struttura rinforzata



314 005 022 406 414
New!



code without color
codice senza colore
28 111 038
28 111 047

cm
38,5
47

cm
34
43,5

L
29
55

min. q.ty
q.tà min.
5
5

AQUA



Water reserve
Riserva d'acqua



UV resistant
UV resistente



Very light
Leggero



Stackable
Impilabile



code without color
codice senza colore

28 109 078
28 109 098



78,5
99



38,5
47



34
43,5



66
130

min. q.ty
q.tà min.

5
5

more resistant
thanks to the
reinforced structure

piu' resistente
grazie alla
struttura rinforzata



Quick-fit iron brackets included
-
Rinforzi in ferro ad incastro rapido
inclusi



314 005 022 406 414

New!

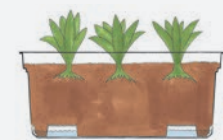

Water diffusion through
osmosis effect
-
Diffusione dell'acqua
per osmosi

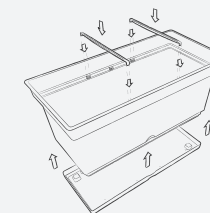

The saucer is included
and is fitted into
-
Il sottovaso è incluso e
viene fissato ad incastro

DISPLAY SOLUTIONS

SOLUZIONI ESPOSITIVE

The display in photo, for demonstration purposes only, contains:
L'espositore in foto, a puro titolo dimostrativo, contiene:

code without color codice senza colore	item description descrizione articolo	q.ty per color q.tà per colore	
		005	406
28 111 038	Still 38	18	18
28 109 078	Aqua 78	18	18

For further information on display solutions, contact the sales team.
Per avere ulteriori informazioni sulle soluzioni espositive contattare la squadra commerciale.



PALBOX 80X120
AQUA 78 + STILL 38

BASILIO

grow your vegetables
with ease and fun
coltivare le tue verdure
è facile e divertente



code
codice

28 113 061 417



cm

34



cm

62,5

min. q.ty
q.tà min.

1

gardening tools
available (pg. 119)
attrezzi da coltivazione
disponibili (pg.119)

Cultivate your passion for the vegetable garden on your terrace. BASILIO will help you do it with ease thanks to its perfect working height. It is simple to install and easy to move thanks to the practical handles.
Fits AQUA 78 and STILL 38.



Coltiva la passione per l'orto anche in terrazzo. BASILIO ti aiuterà a farlo con facilità grazie alla sua altezza perfetta per lavorare. È semplice da montare e facile da spostare grazie alle comode maniglie. Si installa su AQUA 78 e STILL 38.

Screws included.

Note: Holes must be drilled at the time of assembly.



Viteria inclusa.

Nota: il foro deve essere effettuato al momento del montaggio.



DISPLAY SOLUTIONS

SOLUZIONI ESPOSITIVE

The AQUA 78 + BASILIO display contains:

L'espositore AQUA 78 + BASILIO contiene:

code without color codice senza colore	item description descrizione articolo	q.ty per color q.tà per colore
28 109 078	Aqua 78	14
28 113 061	Basilio	14



PALBOX 80X120
AQUA 78 + BASILIO

For further information on display solutions, contact the sales team.

Per avere ulteriori informazioni sulle soluzioni espositive contattare la squadra commerciale.

STEM



Water diffusion through osmosis effect
-
Diffusione dell'acqua per osmosi

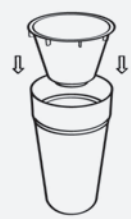

Self watering system included inside the inner vase
-
Riserva d'acqua inclusa nel bicchiere interno



Water reserve
Riserva d'acqua

UV resistant
UV resistente

Very light
Leggero

005 022 406



code without color
codice senza colore

28 124 065
28 124 080



cm



cm



cm



cm



cm



cm



cm

min. q.ty
q.tà min.

5
4

STALK



Water diffusion through osmosis effect
-
Diffusione dell'acqua per osmosi

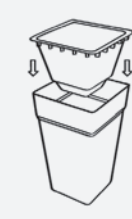

Self watering system included inside the inner vase
-
Riserva d'acqua inclusa nel bicchiere interno

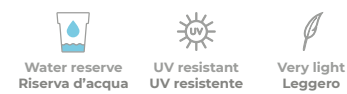

Water reserve
Riserva d'acqua

UV resistant
UV resistente

Very light
Leggero

005 022 406



code without color
codice senza colore

28 123 065
28 123 080



cm



cm



cm



cm



cm



cm



L

min. q.ty
q.tà min.

5
4

STEM LUCE STALK LUCE



- Water reserve
Riserva d'acqua
- UV resistant
UV resistente
- Very light
Leggero
- Lamp
Lampadina



Lamp characteristics: electrical coupling E27, max voltage 220, max electrical power 11 W, LED type lamp.

Caratteristiche lampada: attacco E27, tensione max 220, potenza max 11 W, tipo LED.



022

code without color codice senza colore	cm	cm	cm	cm	cm	L	min. q.ty q.tà min.
32 124 065	38	26,5	65	33	23,5	14	2
32 124 080	38	27	80	33	23,5	14	2



022

code without color codice senza colore	cm	cm	cm	cm	cm	L	min. q.ty q.tà min.
32 123 065	38	26,5	65	33,5	23,5	21	2
32 123 080	38	27	80	33,5	23,5	21	2

DISPLAY SOLUTIONS

SOLUZIONI ESPOSITIVE

The display in photo, for demonstration purposes only, contains:
L'espositore in foto, a puro titolo dimostrativo, contiene:

code without color codice senza colore	item description descrizione articolo	q.ty per color q.tà per colore
28 124 080	Stem 80	9
28 123 080	Stalk 80	9

For further information on display solutions, contact the sales team.

Per avere ulteriori informazioni sulle soluzioni espositive contattare la squadra commerciale.



PALBOX 80X120
STEM 80 + STALK 80

LIGHT BOX STEM + STALK LUCE



Point-of-sale display sample.
Can contain one STALK and one STEM in both sizes 65 and 80. Light Box is a perfect display to emphasise the atmosphere that can be created with the Luce articles from the Elements range.
Available to order.

Campione espositivo per punto vendita.
Può ospitare uno STALK e uno STEM sia nella misura 65 che nella misura 80. Light Box è un perfetto espositore per enfatizzare l'atmosfera che è possibile ricreare con gli articoli Luce della linea Elements.
Disponibile su ordinazione.





COLOUR

INJECTION / INIEZIONE

The new collection that releases all the liveliness of its colors. The choice of different combinations will allow to obtain a surprising and cheerful result, able to enrich even the most anonymous corners of the house.

La nuova collezione che sprigiona tutta la vivacità dei suoi colori. La scelta di combinazioni diverse permetterà di ottenere un risultato sorprendente e allegro, capace di arricchire anche gli angoli più anonimi della casa.



NEW COLOURS NUOVI COLORI

Be inspired by our colour trends!

Give your plants a burst of colour! The new Colour palette is designed to surprise you and bring a breath of fresh colour to your house plants!

Let your imagination run wild. Have fun mixing colours to find a combination that reflects your personality.

Lasciati ispirare dalle nostre tendenze colore!

Dona alle tue piante una sferzata di colori! La nuova palette della linea Colour è nata per sorprendere e portare una ventata di splendide tonalità alle tue piante in casa!

Lascia correre la tua immaginazione. Divertiti a mixare i colori per trovare l'abbinamento che più rispecchia la tua personalità.

enjoy with
new colour palette

divertiti con la nuova
tavolozza di colori

1

OLIVE
COD. 313

2

DENIM
COD. 310

3

CURRY
COD. 308

4

SNOW
COD. 311

5

CORAL
COD. 309

6

OLD ROSE
COD. 312



News
All our inspirations
Tutte le nostre ispirazioni



VELETA

New!



ideal for succulent plants
ideale per piante succulente



Interlocking pot and saucer
- Vaso e sottovaso ad incastro

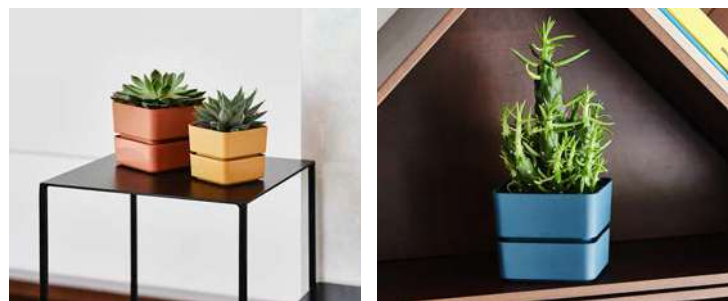

- Matt surface / Superficie opaca
- UV resistant / UV resistente
- Very light / Leggero
- Stackable / Impilabile

- 308
- 309
- 310
- 311
- 312
- 313



code without color
codice senza colore

				min. q.ty q.tà min.
	cm	cm	L	
08 768 009	9,5	8	0,35	14
08 768 012	12	11	0,75	10

SIERRA

New!

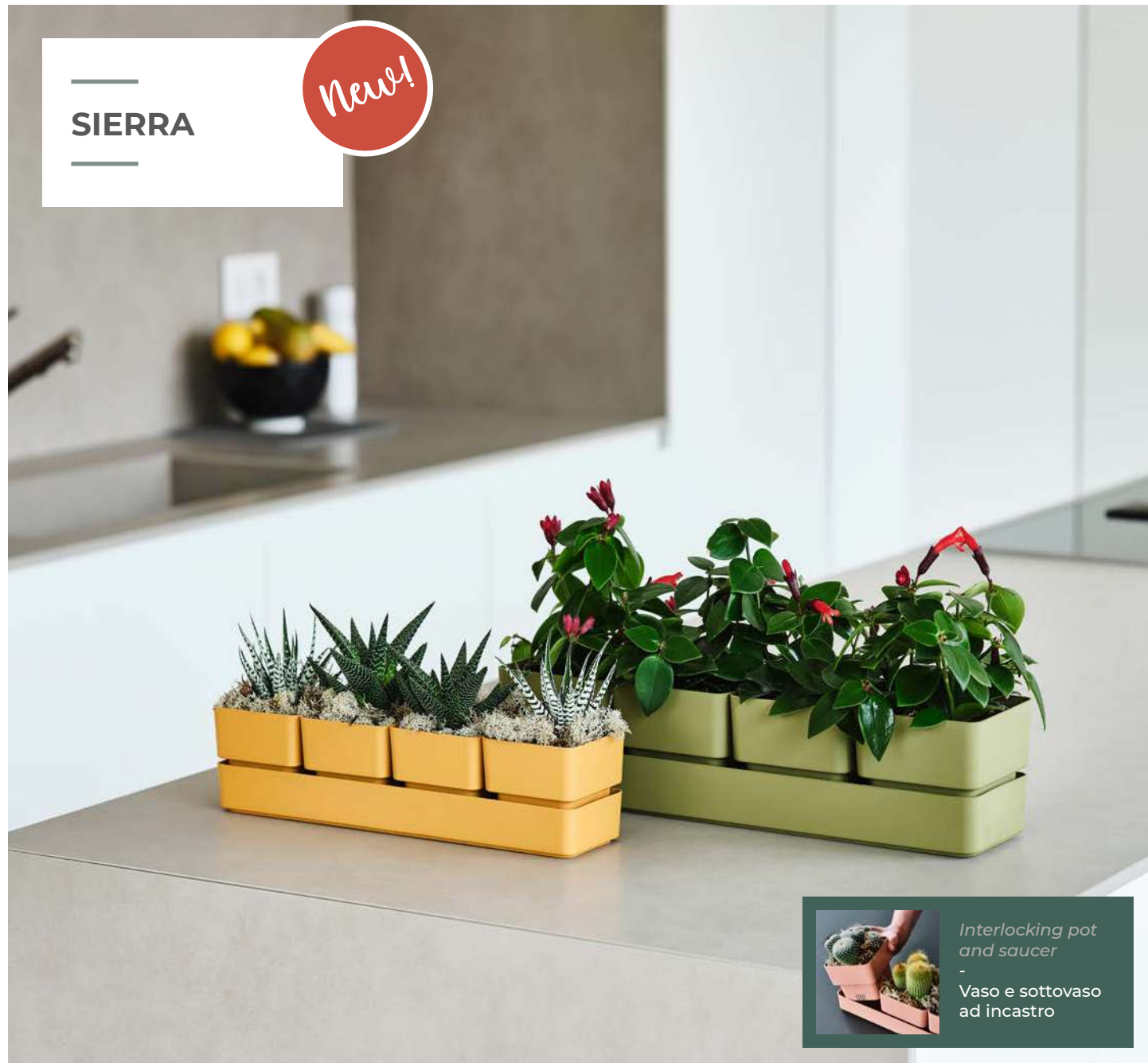

Interlocking pot and saucer
- Vaso e sottovaso ad incastro



- Matt surface / Superficie opaca
- UV resistant / UV resistente
- Very light / Leggero

- 308
- 309
- 310
- 311
- 312
- 313



code without color
codice senza colore

					min. q.ty q.tà min.
	cm	cm	cm	L	
08 769 038	38	9	8	1,4	9
08 769 048	48	12	11	3	6

MADEIRA



308 309 310 311 312 313



code without color
codice senza colore

	cm	cm	cm	L	min. q.ty q.tà min.
08 035 011	11	8	10	0,7	18
08 035 014	13,5	10	12,5	1,4	18
08 035 016	15	11	14	2	18
08 035 018	18	13,5	16	3,3	12
08 035 022	22,5	17	20	6,2	8
08 035 026	24,5	18,5	23	8,8	8

SANTIAGO



308 309 310 311 312 313



code without color
codice senza colore

	cm	cm	L	min. q.ty q.tà min.
08 100 011	11	10,5	1	18
08 100 013	13	12	1,5	18
08 100 015	15	14,5	2,5	12
08 100 020	19	17	5	8

ESTORIL



new
matt finish
nuova finitura
opaca

Water reserve
grid inside
Griglia di riserva
d'acqua all'interno

- Water reserve / Riserva d'acqua
- Matt surface / Superficie opaca
- UV resistant / UV resistente
- Very light / Leggero
- Stackable / Impilabile

- 308
- 309
- 310
- 311
- 312
- 313



code without color codice senza colore	cm	cm	cm	L	min. q.ty q.tà min.
08 037 016	16	10	15,5	1,6	12
08 037 020	20	12	19	3,2	8
08 037 025	25	15	24	6,2	6
08 037 030	30	18	29	11,8	6

PORTO



raised bottom
available in sizes
14 and 16
fondo rialzato
disponibile nelle
misure 14 e 16

- Glossy surface / Superficie lucida
- UV resistant / UV resistente
- Very light / Leggero
- Stackable / Impilabile

- 308
- 309
- 310
- 311
- 312
- 313



code without color codice senza colore	cm	cm	cm	L	min. q.ty q.tà min.
08 083 014	14	8,5	15	1,3	18
08 083 016	16	10	17,5	2	18
08 083 020	20	12,5	21,5	4	12
08 083 025	30	15	27	8	8

ALGARVE





available with
water reserve kit
disponibile con kit
water reserve



308 309 310 311 312 313



code without color
codice senza colore

	 cm	 cm	 L	min. q.ty q.tà min.
08 018 026	14	26	4,4	12
08 018 035	20	35	11	8
08 018 042	24,5	42	20	4

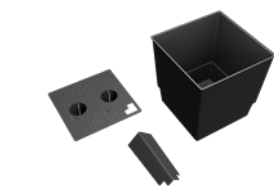

KIT WR
pag. 128





COIMBRA



308 309 310 311 312 313



code without color
codice senza colore

	 cm	 cm	 cm	 L	min. q.ty q.tà min.
08 082 025	26	13	13	3,6	12
08 082 030	30	14,5	15	5,3	12

ORCHIDEA



pot for orchids
with raised bottom
vaso per orchidee
con fondo rialzato

- Glossy surface
Superficie lucida
- UV resistant
UV resistente
- Very light
Leggero
- Stackable
Impilabile

- 308
- 309
- 310
- 311
- 312
- 313



code without color codice senza colore	cm	cm	cm	Lt.	min. q.ty q.tà min.
08 120 014	13	9,5	16	1,3	12
08 120 016	15,5	11	18,5	2,2	12

VILA

New!

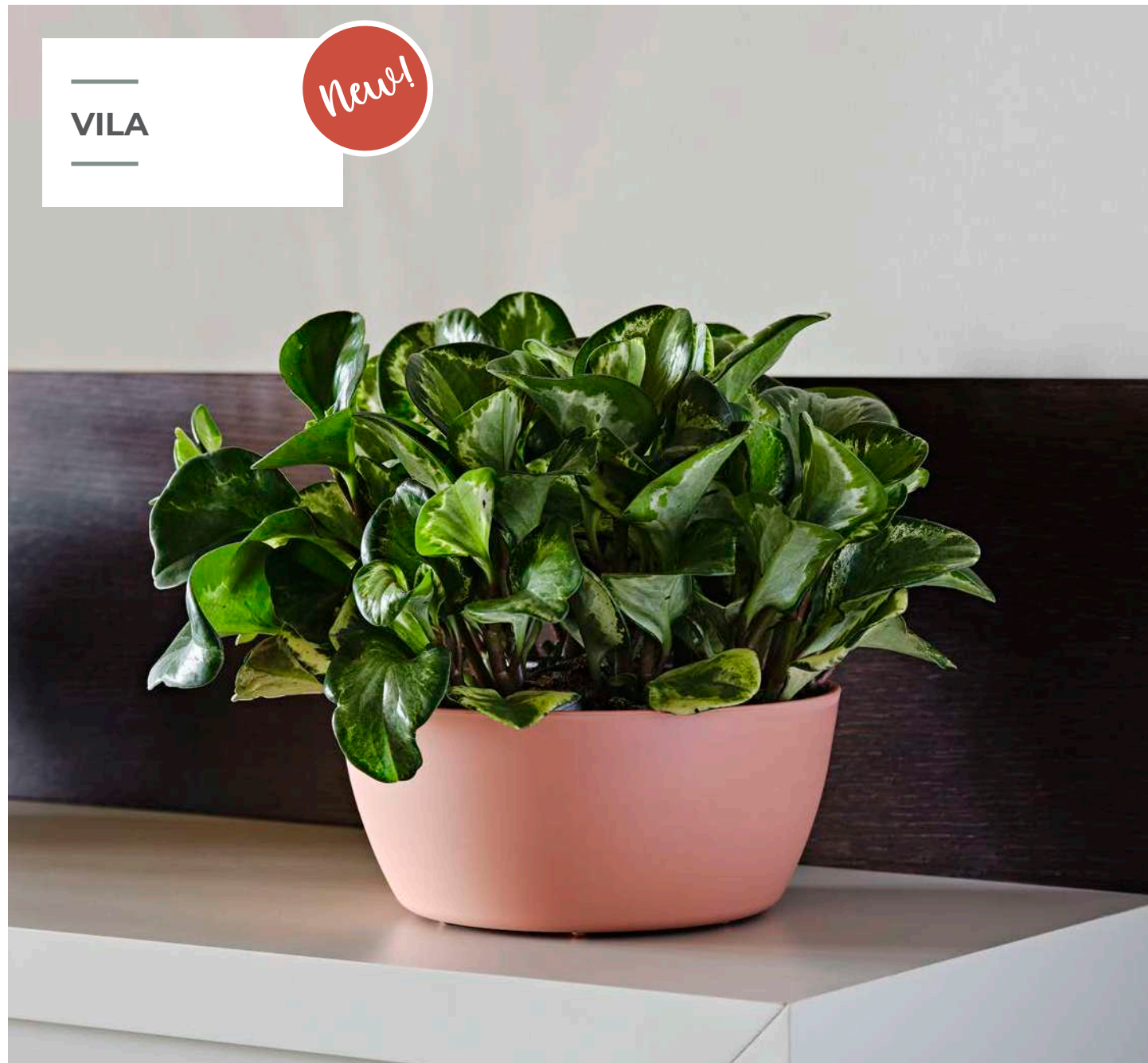

- Matt surface
Superficie opaca
- UV resistant
UV resistente
- Very light
Leggero
- Stackable
Impilabile

- 308
- 309
- 310
- 311
- 312
- 313



code without color codice senza colore	cm	cm	cm	Lt.	min. q.ty q.tà min.
08 770 020	20	15	9	2,1	14
08 770 025	25	19	11	4,2	12
08 770 030	30	22	13,5	7,2	10

SUNRISE



308 309 310 311 312 313



code without color
codice senza colore



cm

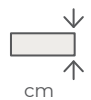

cm



cm



Lt.

min. q.ty
q.tà min.

08 119 036 | 37 | 14,5 | 14 | 5 | 12 |

DISPLAY SOLUTIONS

SOLUZIONI ESPOSITIVE

The display in photo, for demonstration purposes only, contains:
L'espositore in foto, a puro titolo dimostrativo, contiene:

DISPLAY BOX 34X23 VELETA 9



display box code codice display box	item description descrizione articolo	q.ty per box q.tà per box					
1499900599	Veleta 9	308	309	310	311	312	313
		6	6	6	6	6	6

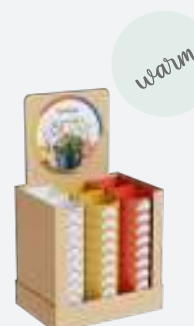

DISPLAY BOX 34X23 MADEIRA 11 + SANTIAGO 11

display box code codice display box	code without color codice senza colore	item description descrizione articolo	q.ty per box q.tà per box		
1499900601	08 035 011 08 100 011	Madeira 11 Santiago 11	308	309	311
			8	8	8
			10	10	10
1499900602	08 035 011 08 100 011	Madeira 11 Santiago 11	310	312	313
			8	8	8
			10	10	10



DISPLAY BOX 42X29 MADEIRA 14 + SANTIAGO 13

display box code codice display box	code without color codice senza colore	item description descrizione articolo	q.ty per box q.tà per box		
1499900605	08 035 014 08 100 013	Madeira 14 Santiago 13	308	309	311
			6	6	6
			10	10	10
1499900606	08 035 014 08 100 013	Madeira 14 Santiago 13	310	312	313
			6	6	6
			10	10	10

DISPLAY BOX 50X34 CLEAR PORTO 16 + ORCHIDEA 16



display box code codice display box	code without color codice senza colore	item description descrizione articolo	q.ty per box q.tà per box	
1499900598	08 083 016 08 120 016	Porto 16 Orchidea 16	024	
			18	
			24	

For further information on display solutions, contact the sales team.
Per avere ulteriori informazioni sulle soluzioni espositive contattare la squadra commerciale.



CLEAR

INJECTION / INIEZIONE

Clear is the perfect transparent line to accommodate all the colors of plants, orchids and small decorative objects for the home. Placed on a table, near a window or mirror the Clear vase is ready to be filled with creativity.

Clear è la linea trasparente perfetta per ospitare tutti i colori delle piante, delle orchidee e di piccoli oggetti decorativi per la casa. Posizionato su un tavolo, vicino ad una finestra o ad uno specchio il vaso Clear è pronto per essere riempito con creatività.



ORCHIDEA



pot for orchids
with raised bottom
vaso per orchidee
con fondo rialzato

- Glossy surface Superficie lucida
- UV resistant UV resistente
- Very light Leggero
- Stackable Impilabile

024 248 249 252 250 251



code without color
codice senza colore

cm	cm	cm	L	min. q.ty q.tà min.	
08 120 014	13	9,5	16	1,3	12
08 120 016	15,5	11	18,5	2,2	12

PORTO



raised bottom
available in sizes
14 and 16

fondo rialzato
disponibile nelle
misure 14 e 16

- Glossy surface Superficie lucida
- UV resistant UV resistente
- Very light Leggero
- Stackable Impilabile

024



code without color
codice senza colore

cm	cm	cm	L	min. q.ty q.tà min.	saucer sottovaso p. 52
08 083 014	14	8,5	15	1,3	12
08 083 016	16	10	17,5	2	14
08 083 020	20	12,5	21,5	4	16
08 083 025	25	15	27	8	20

MADEIRA



MADEIRA

Clear pots are also ideal as multi-purpose container.

I vasi della linea Clear sono ideali anche come contenitore multiuso.

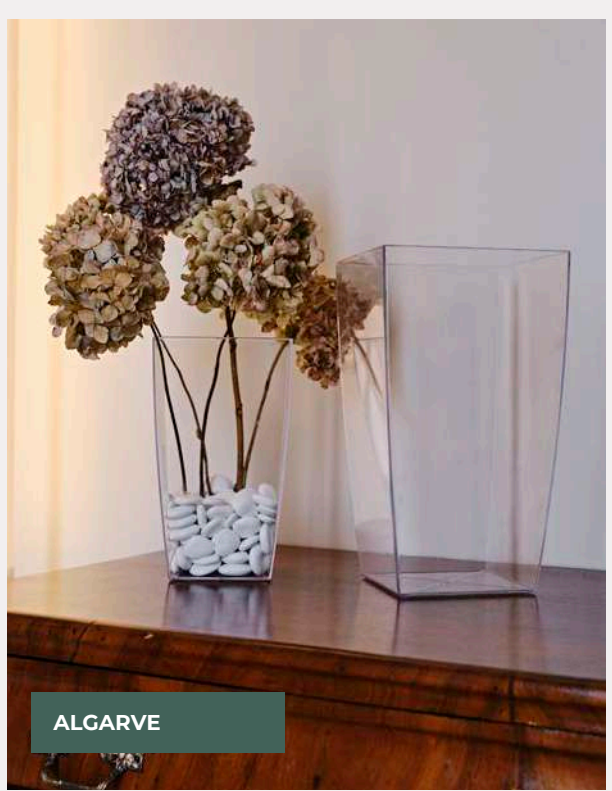

ALGARVE

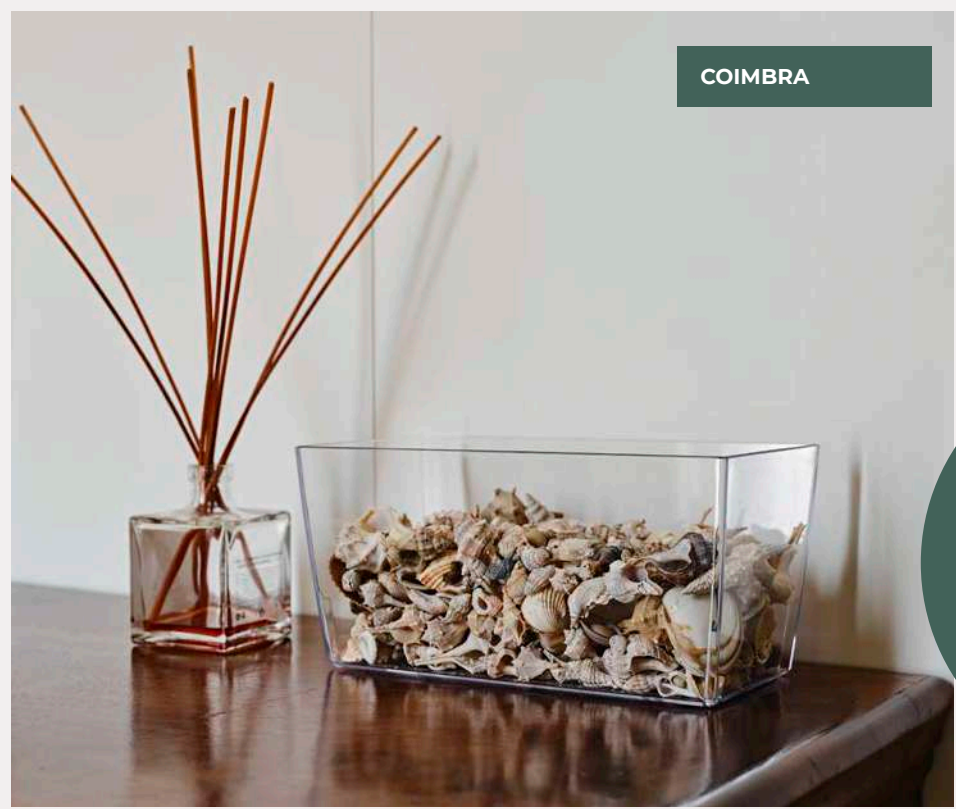

COIMBRA

ideal for compositions and as gift ideas
ideale per composizioni e idee regalo

- Glossy surface Superficie lucida
- UV resistant UV resistente
- Very light Leggero
- Stackable Impilabile



code without color codice senza colore	cm	cm	cm	L	min. q.ty q.tà min.
08 035 011	11	8	10	0,7	18
08 035 014	13,5	10	12,5	1,4	18
08 035 016	15	11	14	2	18
08 035 018	18	13,5	16	3,3	12
08 035 022	22	17	20	6,2	8
08 035 026	24,5	18,5	23	8,8	8

024

COIMBRA



- Glossy surface
Superficie lucida
- UV resistant
UV resistente
- Very light
Leggero
- Stackable
Impilabile

024



code without color codice senza colore	cm	cm	cm	L	min. q.ty q.tà min.
08 082 025	26	13	13	3,6	12
08 082 030	30	14,5	15	5,3	12

ALGARVE



- Glossy surface
Superficie lucida
- UV resistant
UV resistente
- Very light
Leggero
- Stackable
Impilabile

024



code without color codice senza colore	cm	cm	L	min. q.ty q.tà min.
08 018 026	14	26	4,4	12
08 018 035	20	35	11	8
08 018 042	24,5	42	20	4

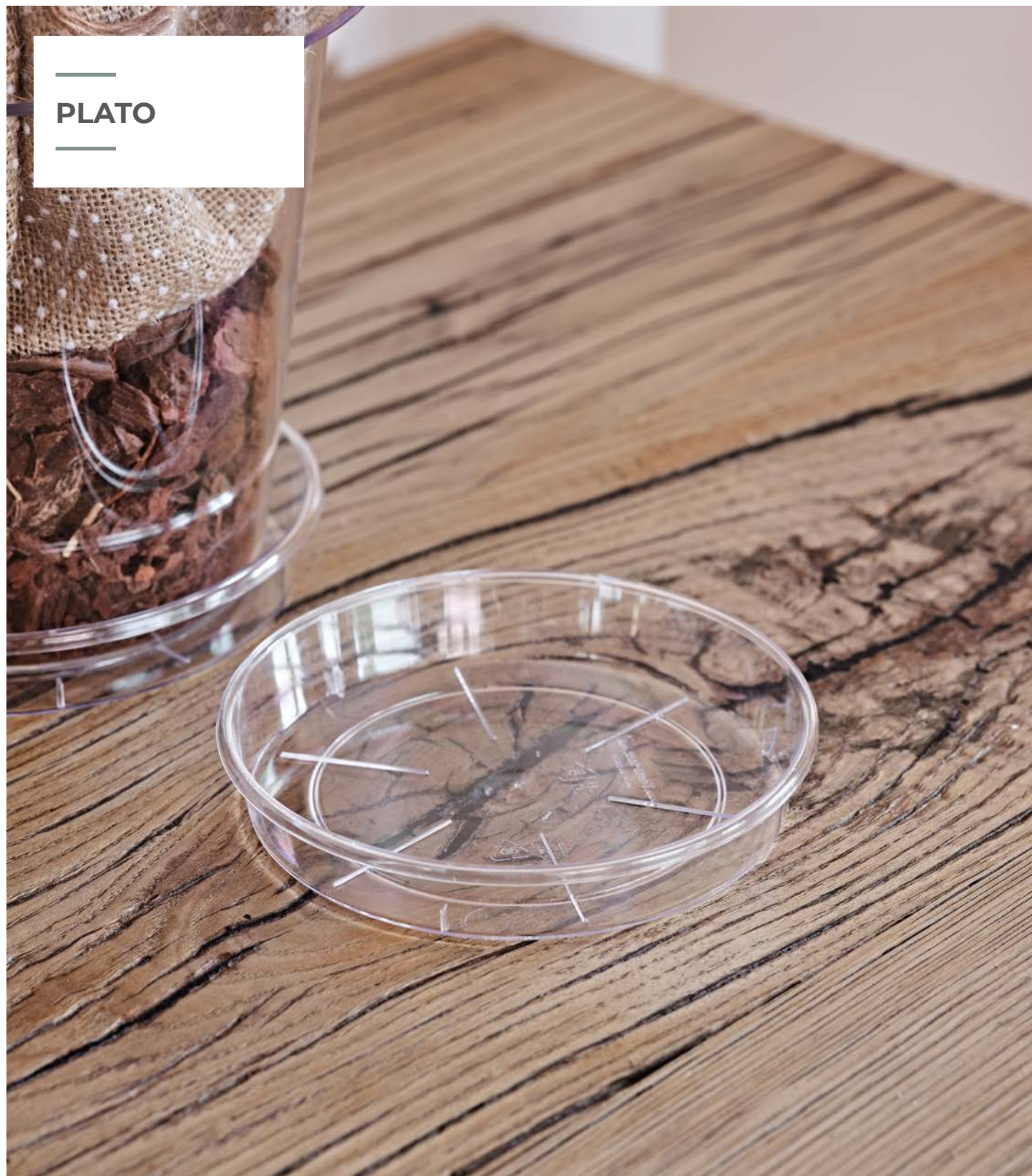

PLATO



024

code without color codice senza colore	cm	cm	min. q.ty q.tà min.
08 086 012	12	3	18
08 086 014	14	2	18
08 086 016	16	3	12
08 086 020	20	3,5	8
08 086 024	24	4	6
08 086 028	28	4,5	4
08 086 032	32	5	2
08 086 036	36,5	5,5	2

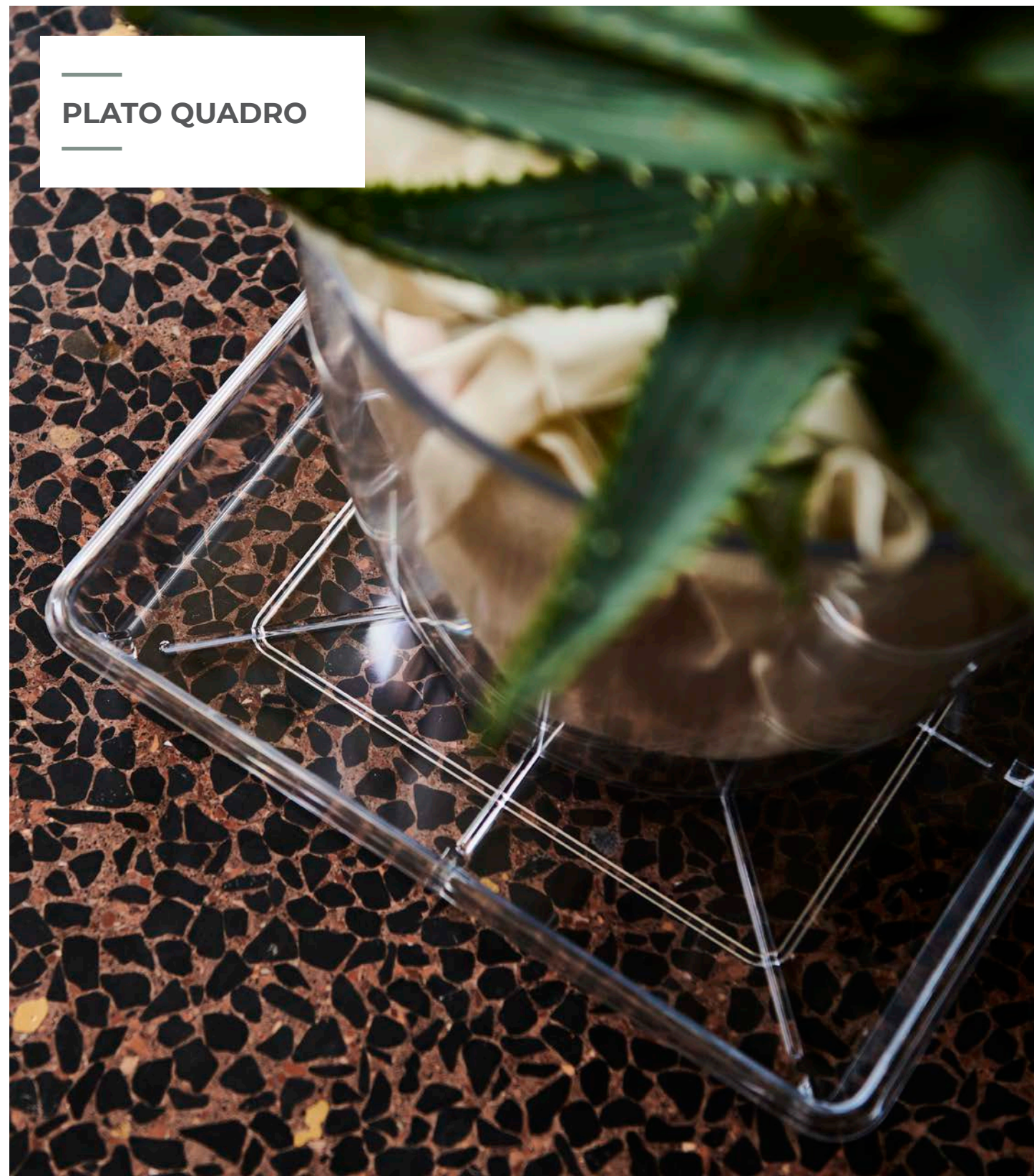

PLATO QUADRO



024

code without color codice senza colore	cm	cm	min. q.ty q.tà min.
08 122 027	27	4	22
08 122 033	33	4	20
08 122 038	38	4,5	20





ESSENTIAL

ROTOMOULD / ROTAZIONALE

Clean surfaces and essential lines make it possible to organise space and furnish in a balanced, minimalist style. The Essential line helps to create an orderly environment by inserting one or more elements while maintaining a uniform style capable of enhancing all the charm of green.

MODULARITY

The simplicity of the lines allows for infinite compositional possibilities. The opportunity to mix pots and planters favours the creation of new corners and personal and welcoming spaces. Different colours and heights give movement and enrich empty walls or bare corners. The perfect combination does not follow precise rules, but relies on creativity and personal taste.

Le superfici pulite e le linee essenziali permettono di organizzare lo spazio e di arredare secondo uno stile equilibrato e minimal.

La linea Essential contribuisce a creare un ambiente ordinato attraverso l'inserimento di uno o più elementi mantenendo uno stile uniforme capace di valorizzare tutto il fascino del verde.

MODULARITÀ

La semplicità nelle linee permette infinite possibilità compositive. L'opportunità di mixare vasi e fioriere favorisce la creazione di nuovi angoli e spazi personali e accoglienti.

Colori e altezze diverse danno movimento e arricchiscono pareti vuote o angoli spogli.

La combinazione perfetta non segue regole precise ma si affida alla creatività e al proprio gusto.



SCHIO CUBO



- Pre-drilled hole / Foro predisposto
- Recyclable / Riciclabile
- UV resistant / UV resistente
- Very light / Leggero

262 032 039 201 235 043 050



code without color codice senza colore	cm	cm	cm	cm	L	min. q.ty q.tà min.	saucer sottovaso p.123
11 425 025	24,5	24,5	24,5	19,5	9	2	x
11 425 030	30	30	30	23,5	15	2	30
11 425 040	40	40	40	30	34	2	40
11 425 050	50	50	50	38	55	2	x
11 425 060	58	60	58	45,5	117	1	x

SCHIO CASSA



- Pre-drilled hole / Foro predisposto
- Recyclable / Riciclabile
- UV resistant / UV resistente
- Very light / Leggero

262 032 039 201 235 043 050



code without color codice senza colore	cm	cm	cm	cm	cm	L	min. q.ty q.tà min.	saucer sottovaso p.123
11 427 060	60	24,5	24,5	54	20	26	2	60
11 427 080	79	30	30	73	24	51	2	80
11 427 100	100	40	40	90	30	108	2	100
11 427 120	115	50	50	103	38	195	1	x

KIT SCHIO CASSA

*stylish, solid
and durable*
*elegante, resistente
e durevole*



Saucer included.
Option of drilling holes in the bottom
for water drainage (pg. 66)

Sottocassetta inclusa.
Possibilità di forare il fondo
per il drenaggio dell'acqua (pg. 66)



Adjustable iron support
The holder can be adjusted according to the thickness
of the railing (55 mm - 132 mm)

Supporto in ferro regolabile
Il supporto può essere regolato a seconda dello spessore
della ringhiera (55 mm - 132mm)

- Pre-drilled hole / Foro predisposto
- Recyclable / Riciclabile
- UV resistant / UV resistente
- Very light / Leggero

- 262
- 032
- 039
- 201
- 235
- 043
- 050



code without color codice senza colore	cm	cm	cm	cm	cm	L	min. q.ty q.tà min.
11 042 060	60	39,5	26	54	20	26	2

SCHIO CASSA MAXI



- Pre-drilled hole / Foro predisposto
- Recyclable / Riciclabile
- UV resistant / UV resistente
- Very light / Leggero

- 262
- 032
- 039
- 201
- 235
- 043
- 050



code without color codice senza colore	cm	cm	cm	cm	cm	L	min. q.ty q.tà min.
11 484 080	78,5	39	39,5	68	30	80	2

SCHIO TOWER









-  Pre-drilled hole
Foro predisposto
-  Recyclable
Riciclabile
-  UV resistant
UV resistente
-  Very light
Leggero
-  Double wall
Doppia parete

262 032 039 201 235 043 050



code without color
codice senza colore

	 cm	 cm	 cm	 cm	 cm	 cm	 L	min. q.ty q.tà min.
11 486 080	79	39	70	68	29	28	52	1
11 486 100	99	39	70	84	29	28	68	1

SCHIO TOWER MAXI









-  Pre-drilled hole
Foro predisposto
-  Recyclable
Riciclabile
-  UV resistant
UV resistente
-  Very light
Leggero
-  Double wall
Doppia parete

262 032 039 201 235 043 050



code without color
codice senza colore

	 cm	 cm	 cm	 cm	 cm	 cm	 L	min. q.ty q.tà min.
11 485 080	79	39	89	68	29	68	68	1

SCHIO
CUBO BASSO



- Pre-drilled hole / Foro predisposto
- Recyclable / Riciclabile
- UV resistant / UV resistente
- Very light / Leggero

262 032 039 201 235 043 050



code without color
codice senza colore



cm



cm



cm



L

min. q.ty
q.tà min.

2

11 456 050 | 49,5 | 19 | 40 | 26 | 2

SCHIO
CUBO ALTO



- Pre-drilled hole / Foro predisposto
- Recyclable / Riciclabile
- UV resistant / UV resistente
- Very light / Leggero
- Double wall / Doppia parete

262 032 039 201 235 043 050



code without color
codice senza colore



cm



cm



cm



cm



L

min. q.ty
q.tà min.

1

11 426 080 | 41 | 79,5 | 31 | 34,5 | 31 | 1

modularity
modularita'



DISCOVER THE DIFFERENT POSSIBLE COMBINATIONS
SCOPRI LE DIVERSE POSSIBILI COMBINAZIONI

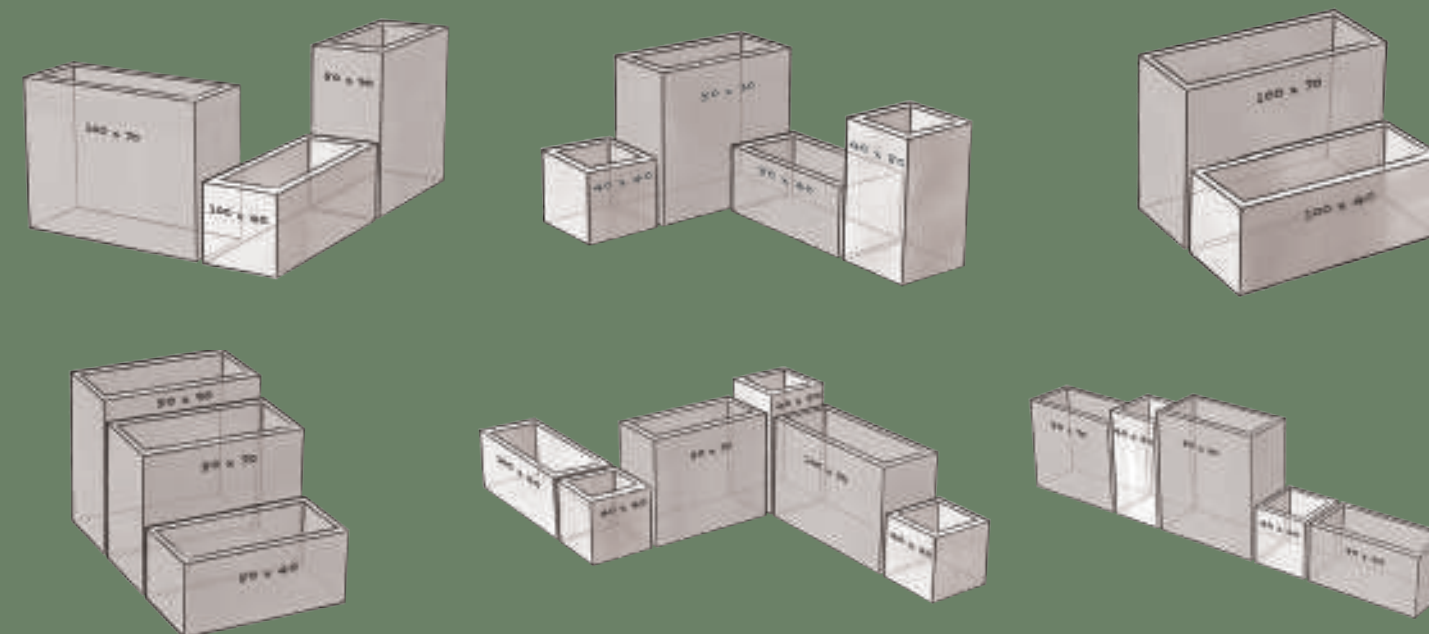

A world of combinations available. The articles of the SCHIO family interact with each other in a very natural way, allowing you to create unique urban green areas. It has never been easier to define spaces, large or small, indoors or outdoors, and the resulting aesthetic impact does not go unnoticed.

Un mondo di combinazioni disponibili. Gli articoli della famiglia SCHIO interagiscono tra loro con grande naturalezza permettendo di creare vere e proprie aree verdi urbane. Delimitare spazi, grandi o piccoli, interni o esterni, non è mai stato più semplice e l'impatto estetico che ne deriva non passa inosservato.

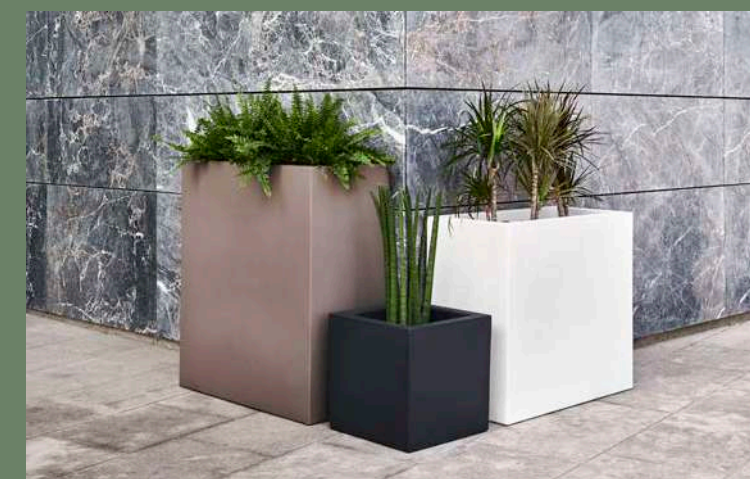

DRAINAGE HOLES FORI DI DRENAGGIO

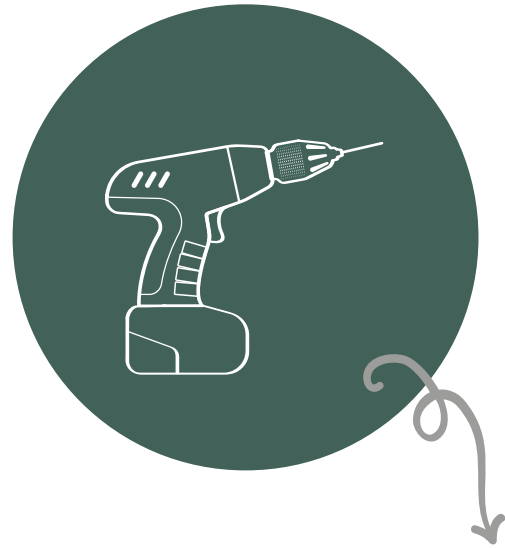

The pots of Essential, Bold, Chic and Ever collections can be easily drilled to allow the drainage of the water.

I vasi delle collezioni Essential, Bold, Chic ed Ever sono facilmente forabili per permettere il drenaggio dell'acqua.

1

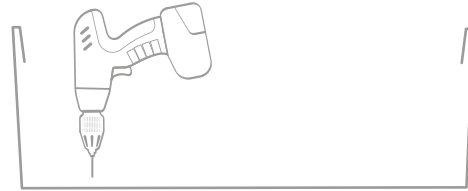

Make the holes perpendicular to the surface

Pratica i fori perpendicolarmente alla superficie

2

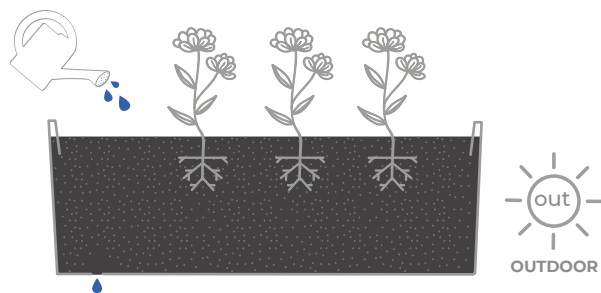

Excess water comes out of the drilled holes

L'acqua in eccesso esce dai fori praticati

3

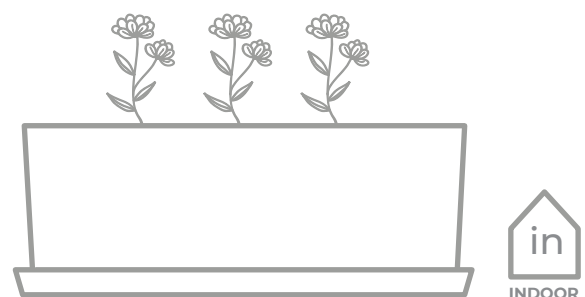

Use a saucer if you use the pot in an indoor environment

Utilizza un sottovaso se posizioni il vaso in un ambiente interno

CORNER

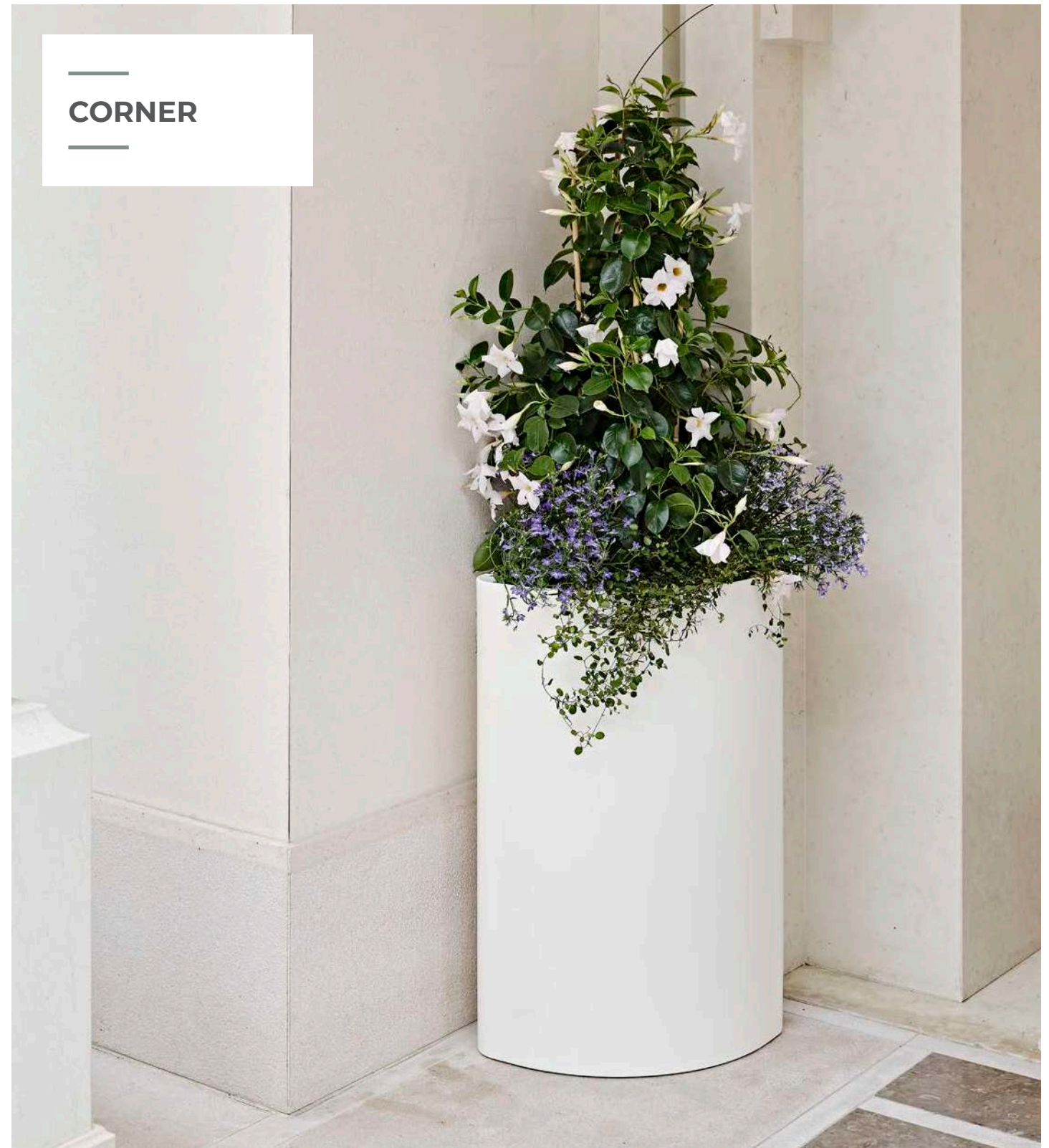

Pre-drilled hole / Foro predisposto
 Recyclable / Riciclabile
 UV resistant / UV resistente
 Very light / Leggero
 Double wall / Doppia parete

032 043 201 235 262

New!



	code without color codice senza colore	cm	cm	cm	cm	L	min. q.ty q.tà min.
INDOOR	11 467 080	39	77,5	22,5	33,5	26	1
OUTDOOR	15 467 080	39	77,5	22,5	33,5	26	1



DIVIO

INDOOR

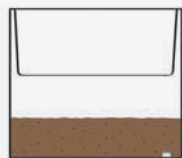

Possibility of inserting sand from the bottom to ballast the pot

- Possibilità di inserimento sabbia dal fondo per zavorrare il vaso

OUTDOOR

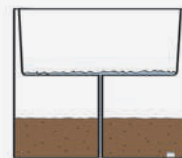

Hole and drainage channel for excess water

- Foro e canale di drenaggio per l'acqua in eccesso

- Pre-drilled hole
Foro predisposto
- Recyclable
Riciclabile
- UV resistant
UV resistente
- Very light
Leggero
- Double wall
Doppia parete

032 043 201 235 262



	code without color codice senza colore	cm	cm	cm	cm	cm	cm	L	min. q.ty q.tà min.
INDOOR	11 466 080	90	27	77,5	85	23	33	59	1
OUTDOOR	15 466 080	90	27	77,5	85	23	33	59	1

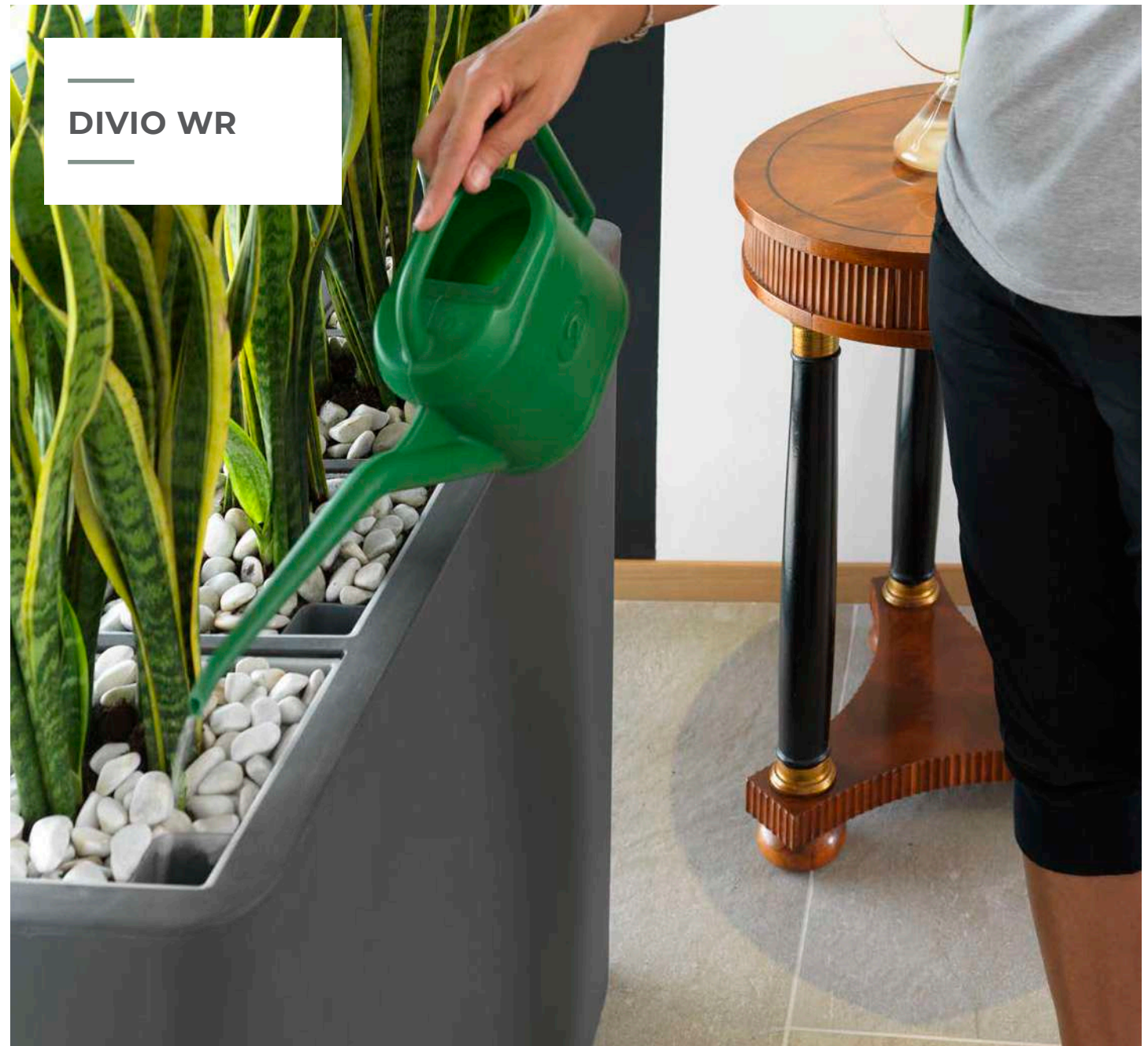

DIVIO WR

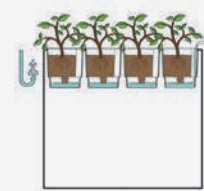

Water diffusion through osmosis effect

- Diffusione dell'acqua per osmosi



Self watering system with spout for easy water insertion

- Riserva d'acqua con beccuccio per agevole innaffiatura

- Water reserve
Riserva d'acqua
- Recyclable
Riciclabile
- UV resistant
UV resistente
- Very light
Leggero
- Double wall
Doppia parete

032 043 201 235 262



	code without color codice senza colore	cm	cm	cm	cm	cm	cm	min. q.ty q.tà min.
	16 466 080	90	27	77,5	19	19	14,5	1

modularity
modularità



DIVIO and CORNER,
modular solutions.

DIVIO e CORNER,
soluzioni componibili
e modulari.

*DIVIO and CORNER are the dividers
of the Essential line.
The design of these planters allows them to be
placed side by side in a harmonious and elegant
way to form a green wall or to delimit a space.*

DIVIO e CORNER rappresentano i divisori
della linea Essential.
Le linee di queste fioriere permettono di
accostarle mantenendo armonia ed eleganza per
formare una parete verde o per delimitare uno
spazio.

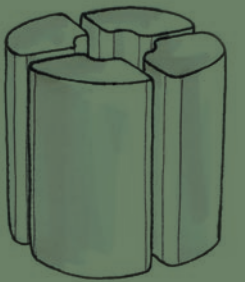
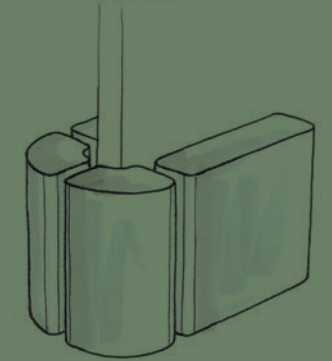
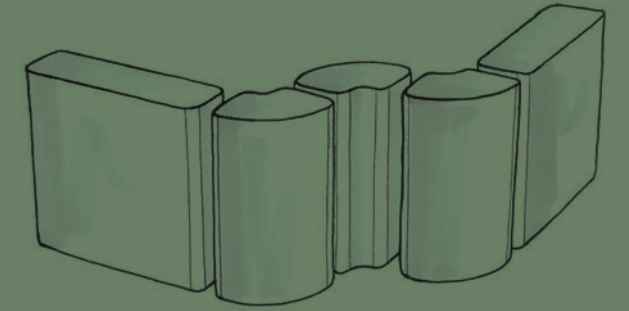
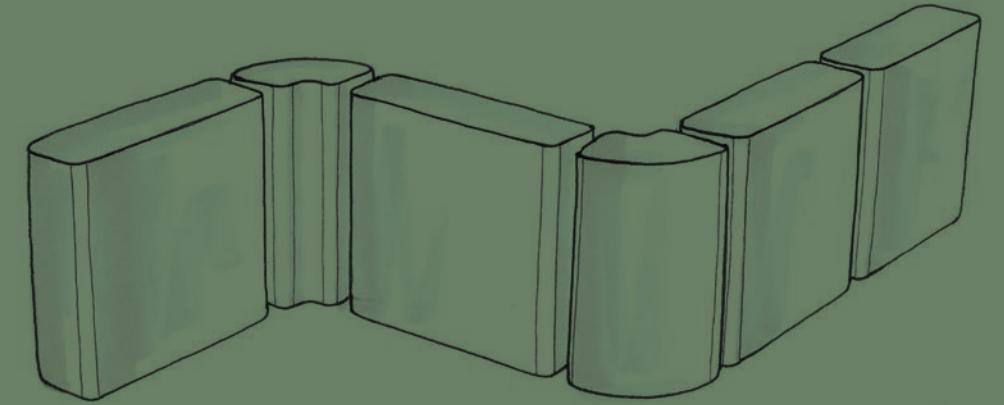

narrow
planters for
maximum space
availability

divisori di spessore
ristretto per
ottimizzare lo spa-
zio disponibile





TRAMA

INJECTION / INIEZIONE

Trama is the modular planter system designed to create green areas and delimit spaces in outdoor environments. The compositions that can be obtained are infinite thanks to the study of joints and junctions between the different components. The surface of this collection is characterised by light grains that recall the naturalness of wood.

Trama solutions are equipped with a water reservoir and the Water Level Indicator to check the water level inside the pot.

Trama è il sistema di fioriere modulari progettato per creare aree verdi e delimitare gli spazi in ambienti outdoor. Le composizioni ottenibili sono infinite grazie allo studio di incastri e giunzioni tra i diversi componenti.

La superficie di questa collezione è caratterizzata da leggere venature che richiamano la naturalezza del legno.

Le soluzioni Trama sono dotate di riserva d'acqua e del Water Level Indicator per controllare il livello di acqua presente all'interno del vaso.





TRAMA 001

New!



The level indicator allows checking the level of water in the water reservoir.
Four adjustment feet to correct the positioning of the pot on any surface.

Attraverso l'indicatore di livello è possibile controllare il livello di acqua presente nella riserva d'acqua. Quattro piedini di regolazione per correggere il posizionamento del vaso su ogni superficie.

Water reserve
Riserva d'acquaWater level
indicatorWheels
RuoteRecyclable
RiciclabileUV resistant
UV resistente

005 311 002 319 320

code without color
codice senza colore

12 717 040



cm



cm



cm



cm



cm



L

min. q.ty
q.tà min.

1



TRAMA 002

New!



The level indicator allows checking the level of water in the water reservoir.
Four adjustment feet to correct the positioning of the pot on any surface.

Attraverso l'indicatore di livello è possibile controllare il livello di acqua presente nella riserva d'acqua. Quattro piedini di regolazione per correggere il posizionamento del vaso su ogni superficie.

Water reserve
Riserva d'acquaWater level
indicatorWheels
RuoteRecyclable
RiciclabileUV resistant
UV resistente

005 311 002 319 320

code without color
codice senza colore

12 718 100



cm



cm



cm



cm



cm



L

min. q.ty
q.tà min.

1

TRAMA 003 *New!*



The level indicator allows checking the level of water in the water reservoir.
Four adjustment feet to correct the positioning of the pot on any surface.

Attraverso l'indicatore di livello è possibile controllare il livello di acqua presente nella riserva d'acqua. Quattro piedini di regolazione per correggere il posizionamento del vaso su ogni superficie.

- Water reserve / Riserva d'acqua
- Water level indicator
- Wheels / Ruote
- Recyclable / Riciclabile
- UV resistant / UV resistente

- 005
- 311
- 002
- 319
- 320



code without color codice senza colore	cm	cm	cm	cm	cm	L	min. q.ty q.tà min.
12 719 100	100	100	40	98	32	225	1

TRAMA
countless possibilities

TRAMA
infinite possibilità



Trama offers endless combinations. Thanks to the multiple components, designed to be linked together, modular solutions can be created to suit different styles and contexts.

Trama offre infinite combinazioni. Grazie ai molteplici componenti, studiati per essere collegati tra loro, è possibile creare soluzioni modulari che si adattano a stili e contesti differenti.



choice of spherical and pyramid knobs, easy to fit

pomelli sferici e pomelli piramidali a scelta, facili da montare

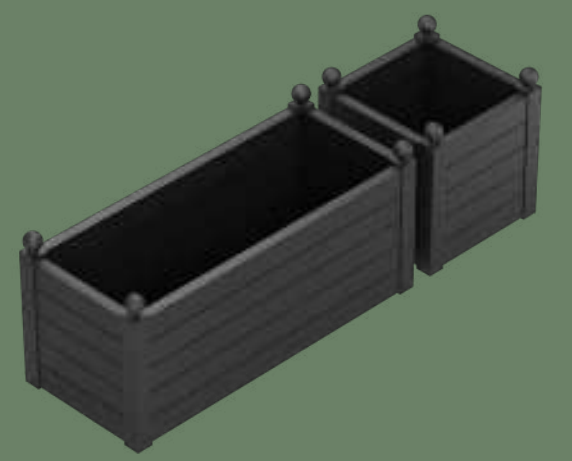



CHIC

ROTOMOULD / ROTAZIONALE

Chic is a mix of shapes through which everyone can express themselves and grow their passion for plants. Refined shapes distinguish this collection that fits into the environments to give elegance.

Chic è un mix di forme attraverso le quali ognuno può esprimersi e far crescere la passione per le piante. Forme raffinate contraddistinguono questa collezione che si inserisce negli ambienti per donare eleganza.









STANDARD ONE



-  Pre-drilled hole / Foro predisposto
-  Recyclable / Riciclabile
-  UV resistant / UV resistente
-  Very light / Leggero
-  Stackable / Impilabile

- 032
- 039
- 201
- 043
- 050



code without color codice senza colore						min. q.ty q.tà min.	saucer sottovaso p.122 
	cm	cm	cm	cm	L		
11 437 030	29,5	18,5	27	26,5	11	4	22
11 437 040	40	25	37	36	26	4	30
11 437 050	50	31	45	44	48	4	37
11 437 060	60,5	37	55	53	85	2	47
11 437 070	70	43	63	62	133	2	50
11 437 080	80	49	71,5	70	199	2	60
11 437 100	99	60	89,5	87	396	2	66
11 437 120	120	74	108	105	686	1	x
11 437 140	140	86	120	123	1079	1	x



IDEAL FOR LARGE PLANTS
IDEALE PER PIANTE DI GRANDI DIMENSIONI

The generous size of STANDARD ONE also allows the planting of tall trees such as olive, pomegranate and eucalyptus or even tropical plants such as palms and banana trees.

Le dimensioni generose dello STANDARD ONE consentono di piantare anche alberi da fusto come l'olivo, melograno ed eucalipto o anche piante tropicali come palme e banani.

AVAILABLE IN LARGE SIZES
DISPONIBILE IN GRANDI DIMENSIONI



suitable for both indoor and outdoor use

adatto sia per uso interno che esterno

SCHIO CONO









-  Pre-drilled hole
Foro predisposto
-  Recyclable
Riciclabile
-  UV resistant
UV resistente
-  Very light
Leggero
-  Double wall
Doppia parete

032 039 201 043



code without color
codice senza colore

	 cm	 cm	 cm	 cm	 cm	 L	min. q.ty q.tà min.
11 424 070	30	22,5	68	22	20	8	1
11 424 090	40	30	90,5	32	26	26	1
11 424 110	44,5	35	110	37	29	35	1
11 424 145	55	45	145	42	31	46	1

SCHIO CIOTOLA







-  Pre-drilled hole
Foro predisposto
-  Recyclable
Riciclabile
-  UV resistant
UV resistente
-  Very light
Leggero
-  Stackable
Impilabile

032 039 201 043



code without color
codice senza colore

	 cm	 cm	 cm	 cm	 L	min. q.ty q.tà min.
11 433 060	59	24,5	22	48	22	2
11 433 080	79,5	33	28,5	64,5	54	2
11 433 100	99,5	41	37	80	106	1

SCHIO
CASSA ALTA



-  Pre-drilled hole
Foro predisposto
-  Recyclable
Riciclabile
-  UV resistant
UV resistente
-  Very light
Leggero
-  Double wall
Doppia parete

032 039 201 043



code without color
codice senza colore

11 428 050
11 428 100

cm	cm	cm	cm	cm	cm	L	min. q.ty q.tà min.
50	35,5	70	40	26	30	31	1
99	35,5	70	89,5	25,5	30	70	1

PASUBIO ALTO



-  Pre-drilled hole
Foro predisposto
-  Recyclable
Riciclabile
-  UV resistant
UV resistente
-  Very light
Leggero
-  Double wall
Doppia parete

032 039 201 043



code without color
codice senza colore

11 462 070
11 462 100

cm	cm	cm	cm	L	min. q.ty q.tà min.
40	68	34	24,5	31	1
40	99,5	34	24,5	31	1



RIBEIRA



- Pre-drilled hole Foro predisposto
- Recyclable Riciclabile
- UV resistant UV resistente
- Very light Leggero
- Stackable Impilabile

032 039 201 043



code without color codice senza colore	cm	cm	cm	cm	L	min. q.ty q.tà min.	saucer sottovaso p.122
11 461 035	33	18,5	29,5	30	13	2	27
11 461 040	38,5	21,5	33	34,5	21	2	30
11 461 050	49	27,5	42	44,5	44	1	33
11 461 060	60	32	49	52	78	1	47
11 461 080	78	43,5	66,5	70	191	1	54



ZAMORA

- Pre-drilled hole Foro predisposto
- Recyclable Riciclabile
- UV resistant UV resistente
- Very light Leggero
- Stackable Impilabile

032 039 201 043



code without color codice senza colore	cm	cm	cm	cm	L	min. q.ty q.tà min.	saucer sottovaso p.122
11 465 043	33	24	43	29,5	24	1	30
11 465 050	38,5	28	50	35	45	1	33
11 465 065	49	36	64,5	44,5	94	1	47



BOLD

ROTOMOULD / ROTAZIONALE

The sophisticated lines of the Bold collection give harmony to the space and the combination of the various elements favors the creation of a nice and pleasant corner of the living room.

Le linee sontuose della collezione Bold donano armonia allo spazio e la combinazione tra i vari elementi favorisce la creazione di un angolo del living curato e piacevole.





LITHOS

New!



The level indicator allows checking the level of water in the water reservoir.

Arrangement for mounting concealed swivel castors.

Attraverso l'indicatore di livello è possibile controllare il livello di acqua presente nella riserva d'acqua. Predisposto per l'allestimento di ruote piroettanti a scomparsa.

- Water reserve / Riserva d'acqua
- Water level indicator
- Wheels / Ruote
- Double wall / Doppia parete
- Recyclable / Riciclabile
- UV resistant / UV resistente
- Very light / Leggero

316 317 318



code without color codice senza colore	cm	cm	cm	cm	L	min. q.ty q.tà min.	wheels ruote p.127
11 778 040	41	40,5	32,5	31	32	1	4



PETRAM

New!



The level indicator allows checking the level of water in the water reservoir.

Arrangement for mounting concealed swivel castors.

Attraverso l'indicatore di livello è possibile controllare il livello di acqua presente nella riserva d'acqua. Predisposto per l'allestimento di ruote piroettanti a scomparsa.

- Water reserve / Riserva d'acqua
- Water level indicator
- Wheels / Ruote
- Double wall / Doppia parete
- Recyclable / Riciclabile
- UV resistant / UV resistente
- Very light / Leggero

316 317 318



code without color codice senza colore	cm	cm	cm	cm	cm	cm	L	min. q.ty q.tà min.	wheels ruote p.127
11 779 080	81	42	40,5	72	31	33,5	79	1	4



ERA

New!

pot arranged
to create
a water reserve

vaso predisposto per
creazione di riserva
d'acqua



- Pre-drilled hole
Foro predisposto
- Wheels
Ruote
- Stackable
Impilabile
- Recyclable
Riciclabile
- UV resistant
UV resistente
- Very light
Leggero

030 201 032 039



code without color
codice senza colore

cm

cm

cm

cm

L

min. q.ty
q.tà min.

wheels
ruote
p.127

code without color codice senza colore	cm	cm	cm	cm	L	min. q.ty q.tà min.	wheels ruote p.127
11 773 040	40	22,5	17,5	36	14	4	x
11 773 050	50	30	20	45	25	2	x
11 773 060	60	36	22	54	42	2	4



ARES

New!

pot arranged
to create
a water reserve

vaso predisposto per
creazione di riserva
d'acqua

- Pre-drilled hole
Foro predisposto
- Wheels
Ruote
- Recyclable
Riciclabile
- UV resistant
UV resistente
- Very light
Leggero

030 201 032 039



code without color
codice senza colore

cm

cm

cm

cm

L

min. q.ty
q.tà min.

wheels
ruote
p.127

WR

code without color codice senza colore	cm	cm	cm	cm	L	min. q.ty q.tà min.	wheels ruote p.127	WR
11 772 030	30	20	23	26	12	4	x	x
11 772 040	40	27,5	30	35	28	2	4	✓
11 772 050	50	35,5	37	44	55	2	4	✓
11 772 060	60	41,5	43,5	53	95	2	6	✓
11 772 070	70	49	51,5	62	153	2	9	✓



METI

New!

pot arranged to create a water reserve
vaso predisposto per creazione di riserva d'acqua

- Water reserve / Riserva d'acqua
- Pre-drilled hole / Foro predisposto
- Wheels / Ruote
- Double wall / Doppia parete
- Recyclable / Riciclabile
- UV resistant / UV resistente
- Very light / Leggero

030 201 032 039

code without color codice senza colore							min. q.ty q.tà min.	wheels ruote p.127	WR
	cm	cm	cm	cm	cm	L			
11 774 030	30	21	45	26	x	24	4	x	x
11 774 040	40	28	59,5	34,5	x	58	2	4	✓
11 774 050	50	32	74	44	34,5	46	2	6	x



DAFNE

New!

- Pre-drilled hole / Foro predisposto
- Wheels / Ruote
- Double wall / Doppia parete
- Recyclable / Riciclabile
- UV resistant / UV resistente
- Very light / Leggero

030 201 032 039

code without color codice senza colore							min. q.ty q.tà min.	wheels ruote p.127
	cm	cm	cm	cm	cm	L		
11 775 040	40	28	80	36	33,5	28	1	4
11 775 050	50,5	35	99,5	44,5	36,5	46	1	6
11 775 060	59,5	41,5	119	53,5	36,5	91	1	6

Bold, a collection of novelties This collection expresses the versatility and functionality of pots, bowls and planters through unusual shapes and finishes. The water reservoir and the addition of wheels to move these articles represent practical solutions for cultivating a passion for plants.

Bold, una collezione di novità. Questa collezione esprime la versatilità e la funzionalità di vasi, ciotole e fioriere attraverso forme e finiture inedite. La riserva d'acqua e l'aggiunta delle ruote per lo spostamento di questi articoli rappresentano soluzioni pratiche per coltivare la passione per le piante.



mix of classic and contemporary lines
mix di linee tra il classico e il contemporaneo



- Pre-drilled hole / Foro predisposto
- Recyclable / Riciclabile
- UV resistant / UV resistente
- Very light / Leggero

030 201 032 039



code without color codice senza colore	cm	cm	cm	cm	L	min. q.ty q.tà min.	saucer sottovaso p.122
11 407 035	29,5	29,5	37,5	25	17	2	30
11 407 040	33	33	41	28,5	25	2	30
11 407 050	40	40	50	34	44	2	36
11 407 060	49	49,5	61,5	42	83	2	36
11 407 065	40	40	65	34	56	2	36

New!

CASSA VENETO



- Pre-drilled hole
Foro predisposto
- Recyclable
Riciclabile
- UV resistant
UV resistente
- Very light
Leggero

030 **201** **032** **039**

New!



code without color codice senza colore	cm	cm	cm	cm	cm	L	min. q.ty q.tà min.
11 438 080	80	40	50	74	35	169	2

JARDINERA VENETO



- Pre-drilled hole
Foro predisposto
- Recyclable
Riciclabile
- UV resistant
UV resistente
- Very light
Leggero

030 **201** **032** **039**

New!



code without color codice senza colore	cm	cm	cm	cm	cm	L	min. q.ty q.tà min.
11 460 058	58,5	29	25	54	17	43	2
11 460 066	66	34	28	61	24	68	2
11 460 080	79	39	33,5	73	33	107	2

**SELF-WATERING SYSTEM
RISERVA D'ACQUA**

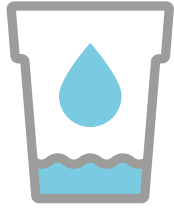

The water reserve allows to feed your plants without the need of frequent watering.

—
La riserva d'acqua permette di alimentare le piante senza bisogno di irrigarle spesso.

**How it works
Come funziona**

The self-watering consists of a reserve of water on the bottom of the pot, that transfers humidity upwards the soil when it dries out. It allows you to cater to your plants' needs without having to water them too often (based on the type of plant and the ambient temperature), so that the plant itself can draw on the contents of the reservoir when it needs them. The drainage hole let out any excess water.

—
Il self-watering system consiste in una riserva d'acqua sul fondo del vaso che trasferisce l'umidità verso l'alto quando il terreno si asciuga. Ti consente di soddisfare le esigenze delle tue piante senza doverle annaffiare troppo spesso (in base al tipo di pianta e alla temperatura ambiente), la pianta può quindi attingere al contenuto della riserva d'acqua quando ne ha necessità. Il foro di drenaggio permette all'acqua in eccesso di uscire.

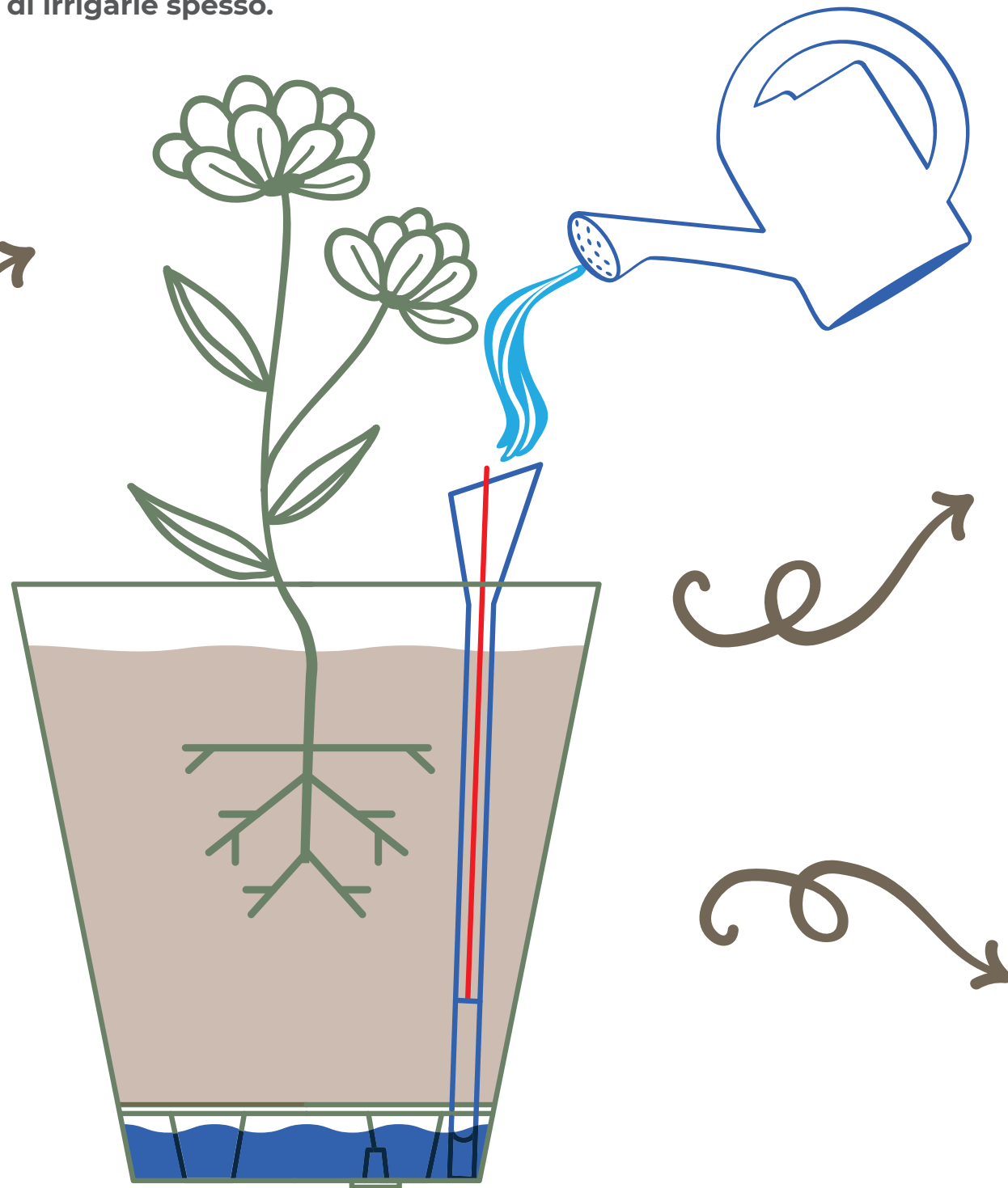

**WATER LEVEL INDICATOR
INDICATORE DI LIVELLO**

In some pots with water reserve can be combined with level indicator, which is easy to assemble and install.

—
In alcuni vasi con riserva d'acqua è possibile abbinare l'indicatore di livello, facile da montare ed installare nel vaso.

The level indicator shows through a float when water needs to be added.

—
L'indicatore di livello segnala attraverso un galleggiante quando è necessario aggiungere acqua.

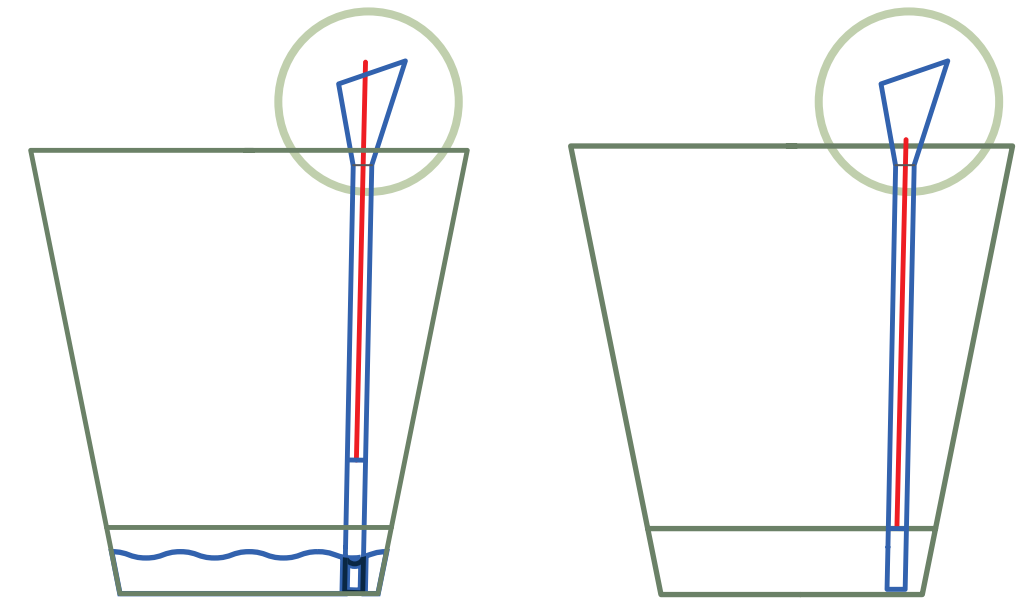

full of water
pieno d'acqua

empty
vuoto

closed hole
foro chiuso

opened hole
foro aperto

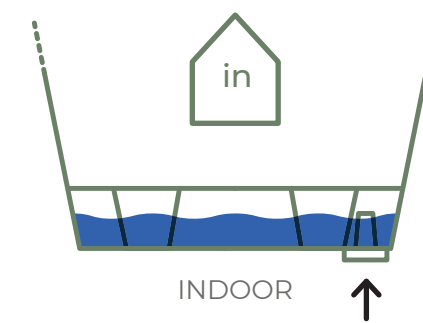

INDOOR

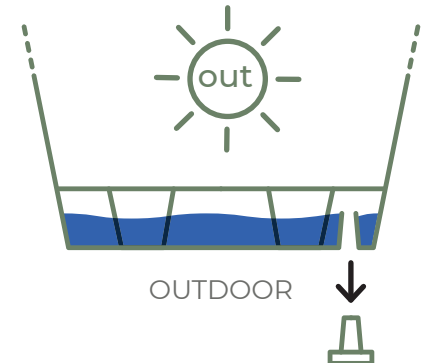

OUTDOOR



EVER

ROTOMOULD / ROTAZIONALE

The warmth and beauty of the Ever line is typical of traditional style. It represents a timeless art that is expressed through traditional decorations, festoons and striped textures.

Il calore e la bellezza della linea Ever è tipica dello stile tradizionale. Rappresenta un'arte intramontabile che si esprime attraverso i decori della tradizione, festoni e texture rigate.



FESTONATO



-  Pre-drilled hole
Foro predisposto
-  Recyclable
Riciclabile
-  UV resistant
UV resistente
-  Very light
Leggero
-  Stackable
Impilabile

030



code without color codice senza colore	cm	cm	cm	L	min. q.ty q.tà min.	saucer sottovaso p.122
02 400 030	30	16,5	25	8	4	22
02 400 035	34	20	29,5	15	4	27
02 400 040	40	22	34,5	22	4	30
02 400 045	44,5	26	39	34	2	33
02 400 050	49,5	28,5	42	45	2	37
02 400 055	56	32,5	47	67	2	40
02 400 060	61,5	35	50	85	2	47
02 400 070	69	40	57	125	1	47
02 400 080	76	42,6	61,5	232	1	50

CASSETTA
LEONARDO



-  Pre-drilled hole
Foro predisposto
-  Recyclable
Riciclabile
-  UV resistant
UV resistente
-  Very light
Leggero

032 030



code without color codice senza colore	cm	cm	cm	L	min. q.ty q.tà min.	saucer sottovaso p.122
02 406 060	58	26	28	29	2	60
02 406 080	77,5	32,5	33,5	57	2	80
02 406 100	99	40	44	120	2	100

STANDARD ONE



- Pre-drilled hole Foro predisposto
- Recyclable Riciclabile
- UV resistant UV resistente
- Very light Leggero
- Stackable Impilabile

030



code without color codice senza colore	cm	cm	cm	L	min. q.ty q.tà min.	saucer sottovaso p.122
11 437 030	29,5	18,5	27	11	4	22
11 437 040	40	25	37	26	4	30
11 437 050	50	31	45	48	4	37
11 437 060	60,5	37	55	85	2	47
11 437 070	70	43	63	133	2	50
11 437 080	80	49	71,5	199	2	60
11 437 100	99	60	89,5	396	2	66
11 437 120	120	74	108	686	1	x
11 437 140	140	86	120	1079	1	x

DOPPIO BORDO



- Pre-drilled hole Foro predisposto
- Recyclable Riciclabile
- UV resistant UV resistente
- Very light Leggero
- Stackable Impilabile

030



code without color codice senza colore	cm	cm	cm	L	min. q.ty q.tà min.	saucer sottovaso p.122
02 401 030	29,5	16	24,5	8	4	22
02 401 035	35	20	30	15	4	27
02 401 040	38	22,5	34,5	22	4	30
02 401 045	45	26	39	34	2	33
02 401 050	50	28,5	42,5	45	2	37
02 401 055	55,5	32,5	47	67	2	40
02 401 060	60,5	35	50	85	2	47
02 401 070	69,5	40	57	125	1	47
02 401 085	85	52,5	70	232	1	60

EOS

New!



pot arranged to create a water reserve
vaso predisposto per creazione di riserva d'acqua

- Water reserve / Riserva d'acqua
- Pre-drilled hole / Foro predisposto
- Wheels / Ruote
- Stackable / Impilabile
- Recyclable / Riciclabile
- UV resistant / UV resistente
- Very light / Leggero

030



code without color / codice senza colore



min. q.ty / q.tà min.

wheels / ruote

wheels w/ brake / ruote con freno

WR

code without color / codice senza colore	cm	cm	cm	Lt.	min. q.ty / q.tà min.	wheels / ruote p.127	wheels w/ brake / ruote con freno p.127	WR
02 777 080	80	59	58	190	1	2	2	✓
02 777 100	100	70	73	370	1	5	2	✓
02 777 120	118	88	82	620	1	8	2	✓
02 777 150	150	93	102	1200	1	14	2	✓



pot of large size up to 150 cm
vaso di grandi dimensioni fino a 150 cm



CIRCUM

New!

pot arranged
to create a water
reserve

vaso predisposto per
creazione di riserva
d'acqua



032 030



code without color codice senza colore	cm	cm	cm	cm	L	min. q.ty q.tà min.	wheels ruote p.127	WR
02 776 040	40	21,5	17	34	13	2	x	✓
02 776 050	50	26	20	43	24	2	x	✓
02 776 060	60	30,5	22,5	52	40	2	4	✓
02 776 080	80	39,5	30	69	90	1	6	✓
02 776 100	100	47	36	86	168	1	9	✓



CILINDRO
VICENZA



032 030



code without color codice senza colore	cm	cm	L	min. q.ty q.tà min.	saucer sottovaso p.122
02 443 040	39	31	26	4	37
02 443 045	44,5	35	40	2	47
02 443 050	48,5	38	52	2	47
02 443 060	58	46	94	2	54
02 443 070	69	53,5	145	1	66



**QUADRO
MILLERIGHE**



-  Pre-drilled hole
Foro predisposto
-  Recyclable
Riciclabile
-  UV resistant
UV resistente
-  Very light
Leggero

032 030



code without color codice senza colore	 cm	 cm	 L	min. q.ty q.tà min.	saucer sottovaso p.122
02 409 035	34	34,5	28	2	36
02 409 040	38,5	39,5	41	2	46
02 409 045	44	40	59	2	46





**CASSETTA
MILLERIGHE**



-  Pre-drilled hole
Foro predisposto
-  Recyclable
Riciclabile
-  UV resistant
UV resistente
-  Very light
Leggero

032 030



code without color codice senza colore	 cm	 cm	 cm	 L	min. q.ty q.tà min.	saucer sottovaso p.122
02 408 060	58,5	26,5	27,5	32	2	60
02 408 080	80	35	35	70	2	80
02 408 100	100,5	44	43	146	2	100



**QUADRO
LISCIO**



-  Pre-drilled hole
Foro predisposto
-  Recyclable
Riciclabile
-  UV resistant
UV resistente
-  Very light
Leggero

032 030



code without color codice senza colore	 cm	 cm	 L	min. q.ty q.tà min.	saucer sottovaso p.122
02 445 040	40	35	35	2	46
02 445 046	46	41	56	2	46
02 445 055	55	48	95	2	56





**CASSETTA
LISCIA**



-  Pre-drilled hole
Foro predisposto
-  Recyclable
Riciclabile
-  UV resistant
UV resistente
-  Very light
Leggero

032 030



code without color codice senza colore	 cm	 cm	 cm	 L	min. q.ty q.tà min.	saucer sottovaso p.122
02 444 080	80,5	40,5	35	78	2	80
02 444 100	100	46	41	133	2	100



TOOLS

INJECTION / INIEZIONE

A wide selection of colourful, solid and very useful items for the care of your plants and vegetables.

Un'ampia selezione di articoli colorati, solidi e molto utili per la cura delle vostre piante e del vostro orto.





BELEM

New!

Graduated scale in both models
Scala graduata in entrambi i modelli

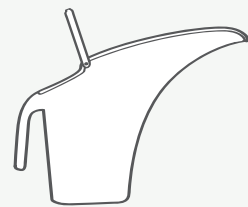

BELEM 4 L
Equipped with handle for easy usage
Dotato di maniglia per un utilizzo più agevole

Recyclable / Riciclabile
UV resistant / UV resistente
Very light / Leggero

414 308 002



code without color codice senza colore	cm	cm	cm	L
06 157 000	36	15	25	2
06 158 000	44	20	32	4



GAIA

New!

Trowels and extractor with graduated scale
Trapiantatori ed estirpatore con scala graduata

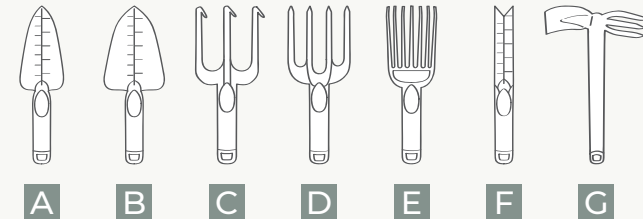

Recyclable / Riciclabile
UV resistant / UV resistente
Very light / Leggero

414 308 002



code without color
codice senza colore

06 159 000	GAIA 01
06 160 000	GAIA 02
06 161 000	GAIA 03
06 162 000	GAIA 04
06 163 000	GAIA 05
06 164 000	GAIA 06
06 168 000	GAIA 07

Description	fig.	cm	min. q.ty q.tà min.
Trowel S - Trapiantatore S	A	30	12
Trowel L - Trapiantatore L	B	30	12
Cultivator - Tridente	C	29	12
Fork - Forca	D	28	12
Rake - Rastrello	E	27	12
Extractor - Estirpatore	F	34	12
Hand Hoe - Zappetta	G	30	12



SAUCERS

ROTOMOULD / ROTAZIONALE

Teraplast offers a wide range of saucers to combine with the articles of the various collections to make each product complete, refined and functional.

Teraplast propone una vasta gamma di sottovasi e sottocassette da abbinare agli articoli delle varie collezioni per rendere ogni prodotto completo, ricercato e funzionale.



SOTTOVASO ROTONDO EVER

Recyclable
RiciclabileUV resistant
UV resistenteVery light
Leggero

code without color
codice senza colore

cm

cm

min. q.ty
q.tà min.

Colours

02 415 022	22	4	10	030	032	039	201	043	050
02 415 027	27	4	10	030	032	039	201	043	
02 415 030	30	4	8	030	032	039	201	043	050
02 415 033	33	4	8	030	032	039	201	043	
02 415 037	37	4	8	030	032	039	201	043	050
02 415 040	40	5	8	030	032				
02 415 047	47	5	6	030	032	039	201	043	050
02 415 050	50	5	6	030	032	039	201	043	050
02 415 054	54	5	4	030	032	039	201	043	
02 415 060	60	5	4	030	032	039	201	043	050
02 415 066	66	6	4	030	032	039	201	043	050



SOTTOCUBO SCHIO

Recyclable
RiciclabileUV resistant
UV resistenteVery light
Leggero

code without color
codice senza colore

cm

cm

min. q.ty
q.tà min.

11 480 030	30	4,5	2
11 480 040	40	5,5	2



262 032 039 201 235 043 050

SOTTOVASO QUADRO EVER

Recyclable
RiciclabileUV resistant
UV resistenteVery light
Leggero

code without color
codice senza colore

cm

cm

min. q.ty
q.tà min.

Colours

02 417 030	30	5	2	030	032	039	201
02 417 036	36	5	2	030	032	039	201
02 417 046	46	5	2	030	032		
02 417 056	56	5	2	030	032		



SOTTOCASSETTONE SCHIO

Recyclable
RiciclabileUV resistant
UV resistenteVery light
Leggero

code without color
codice senza colore

cm

cm

cm

min. q.ty
q.tà min.

11 479 060	60	4	24,5	2
11 479 080	80	4,5	29,5	2
11 479 100	100	5,5	41	2



262 032 039 201 235 043 050

SOTTOCASSETTONE EVER

Recyclable
RiciclabileUV resistant
UV resistenteVery light
Leggero

code without color
codice senza colore

cm

cm

cm

min. q.ty
q.tà min.

02 416 060	60	5	30	2
02 416 080	80	5	36	2
02 416 100	100	5	45	2



030 032



ACCESSORIES

MOVER

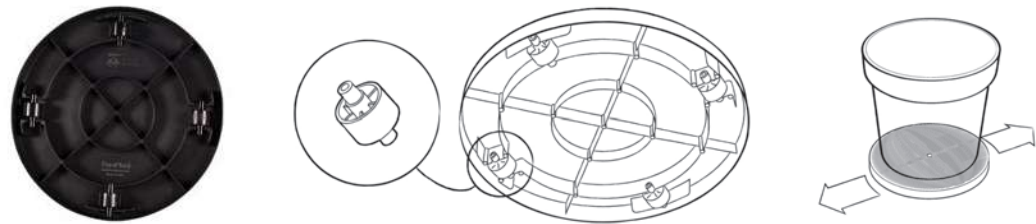
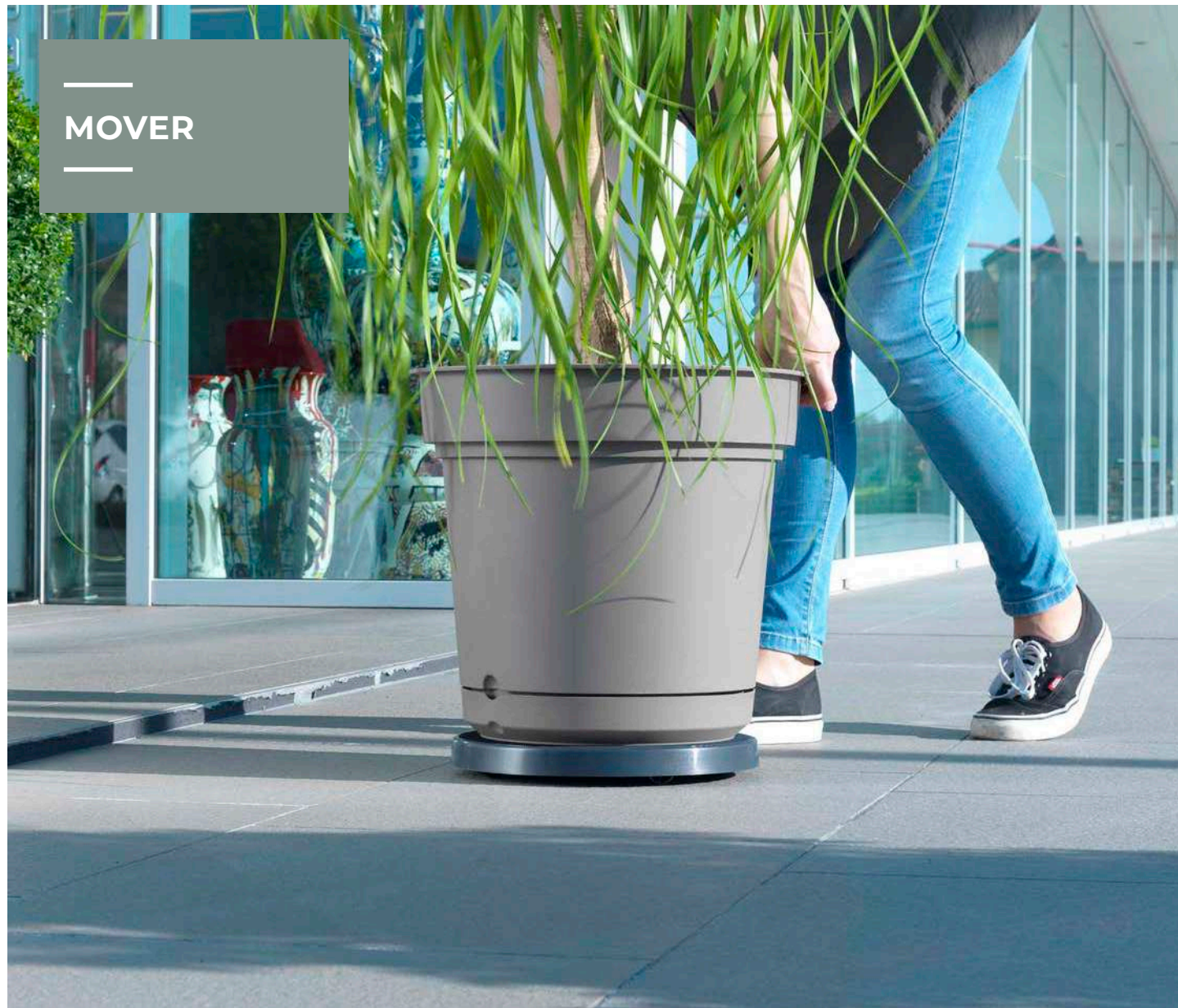

item code codice articolo	cm	cm	min. q.ty q.tà min.
10 121 029	29	2,5	4
10 121 034	34	2,5	4
10 121 039	39	2,5	4

SWIVEL CASTORS
RUOTE PIROETTANTI



Multidirectional castors are the solution for moving even the heaviest items with ease. The castors are very easy to install thanks to the interlocking system, without the use of tools.

Le ruote multidirezionali rappresentano la soluzione per spostare con facilità anche gli articoli più pesanti. Le ruote piroettanti sono facili da installare grazie al sistema ad incastro, senza l'uso di utensili.

*comes with 4 self-tapping screws
*comprensivo di 4 viti autofilettanti



item code codice articolo	cm	Kg	Pcs.	min. q.ty q.tà min.
10902002000	3,5	30kg/pc	9	1
10902005000	3,5	30kg/pc	4	1
10902007000	3,5	30kg/pc	6	1



item code codice articolo	cm	Kg	min. q.ty q.tà min.	
10902010000*	39	100kg/pc	1	without brake / senza freno
10902011000*	39	100kg/pc	1	with brake / con freno

WATER RESERVE KIT

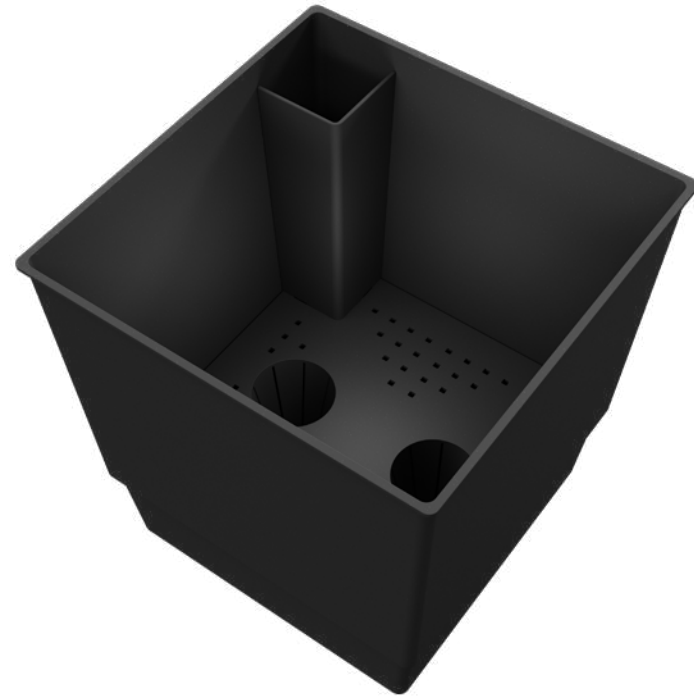

item code codice articolo	cm	min. q.ty q.tà min.
08 089 026 238	15	12
08 089 035 238	20	12
08 089 042 238	25	12

238



FIX GROUND

FIX ACCESSORIES:
very simple but safe to use items. Fixed to a wall or on the floor, they considerably reduce possibilities of accidental tipping.

ACCESSORI FIX:
articoli molto semplici ma di sicuro utilizzo. Fissati a una parete o sul pavimento riducono notevolmente le possibilità di ribaltamento accidentale.



FIX GROUND ROUND

item code codice articolo	cm	cm	min. q.ty q.tà min.
10 903 041	41	0,5	2
10 903 048	48	0,5	2
10 903 060	60	0,5	2

FIX GROUND SQUARE

item code codice articolo	cm	cm	min. q.ty q.tà min.
10 908 039	39	0,5	2



FIX
WALL



Padlock
not included

Il lucchetto
non è incluso



item code codice articolo	 cm	 cm	 cm	min. q.ty q.tà min.
10 904 007	25	7	0,5	2

A

AIR.....17
 ALGARVE.....38
 ALGARVE clear.....51
 AQUA.....20
 ARES.....93

B

BASILIO.....22
 BELEM.....118

C

CASSA VENETO.....98
 CASSETTA LEONARDO.....105
 CASSETTA LISCIA.....115
 CASSETTA MILLERIGHE.....113
 CILINDRO VICENZA.....111
 CIRCUM.....110
 COIMBRA.....39
 COIMBRA clear.....50
 CORNER.....67

D

DAFNE.....95
 DISPLAY BOX COLOUR/CLEAR.....43
 DIVIO.....68
 DIVIO SELF WATERING.....69
 DOPPIO BORDO.....107

E

EOS.....108
 ERA.....92
 ESTORIL.....36

F

FESTONATO.....104
 FIX GROUND.....129
 FIX WALL.....130

G

GAIA.....119

H

HYDRAL.....14

I

IRON DISPLAY HYDRAL.....15

J

JARDINERA VENETO.....99

K

KIT HYDRAL.....16
 KIT SCHIO CASSA.....58

L

LIGHT BOX STEM + STALK LUCE.....27
 LITHOS.....90

M

MADEIRA.....34
 MADEIRA clear.....48
 METI.....94
 MOVER.....126

O

ORCHIDEA.....40
 ORCHIDEA clear.....46

P

PALBOX AQUA + BASILIO.....23
 PALBOX AQUA + STILL.....21
 PALBOX STEM + STALK.....27
 PASUBIO ALTO.....85
 PETRAM.....91
 PLATO.....52
 PLATO QUADRO.....53
 PORTO.....37
 PORTO clear.....47

Q

QUADRO LISCIO.....114
 QUADRO MILLERIGHE.....112
 QUADRO VENETO.....97

R

RIBEIRA.....86
 RUOTE PIROETTANTI.....127

S

SANTIAGO.....35
 SCHIO CASSA.....57
 SCHIO CASSA ALTA.....84
 SCHIO CASSA MAXI.....59
 SCHIO CIOTOLA.....83
 SCHIO CONO.....82
 SCHIO CUBO.....56
 SCHIO CUBO ALTO.....63
 SCHIO CUBO BASSO.....62
 SCHIO TOWER.....60
 SCHIO TOWER MAXI.....61
 SIERRA.....33
 SOTTOCASSETTONE EVER.....122
 SOTTOCASSETTONE SCHIO.....123
 SOTTOCUBO SCHIO.....123
 SOTTOVASO QUADRO EVER.....122
 SOTTOVASO ROTONDO EVER.....122
 STALK.....25
 STANDARD ONE.....80-106
 STEM.....24
 STEM LUCE.....26
 STILL.....18
 SUNRISE.....42

T

TRAMA 001.....74
 TRAMA 002.....75
 TRAMA 003.....76

V

VELETA.....32
 VILA.....41

W

WATER RESERVE KIT.....128

Z

ZAMORA.....87

INJECTION

INIEZIONE



INJECTION Colour

INIEZIONE Colour



INJECTION Clear

INIEZIONE Clear



ROTOMOULD

ROTAZIONALE

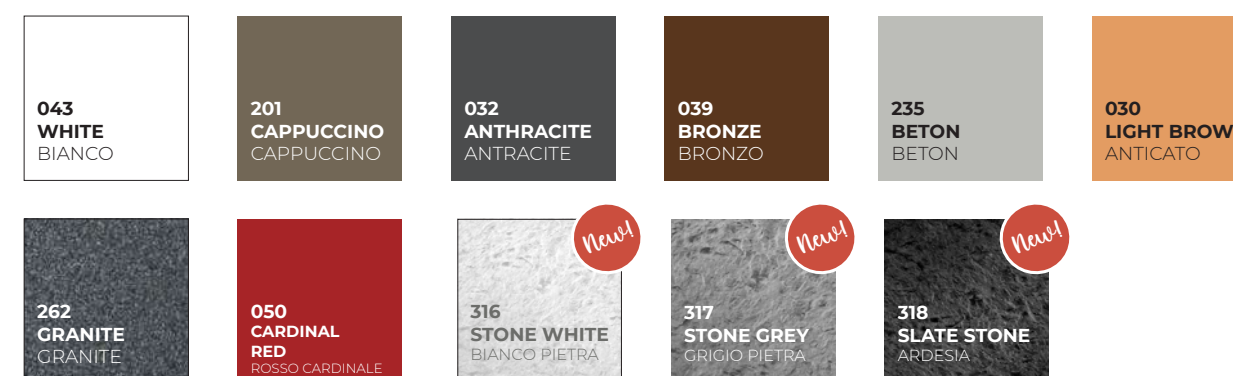

LEGENDA / LEGENDA



Matt surface
Superficie opaca



Saucer included
Sottovaso incluso



Very light
Leggerissimo

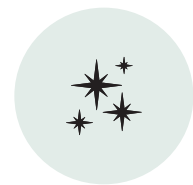

Glossy surface
Superficie lucida



Shock resistant
Resistente agli urti



Pivoting wheels available
Ruote piroettanti
disponibili



Self watering
Riserva d'acqua



*Recyclable Ecological
non-toxic*
Riciclabile Ecologico
atossico



Stackable
Impilabile



*Waster Level Indicator
available*
Indicatore di livello
dell'acqua disponibile



Illuminated
Con lampadina



Can be drilled to drainage
Foro predisposto

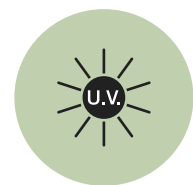

*U.V. resistant
Colour-fast*
U.V. resistant
Inalterabile nel colore

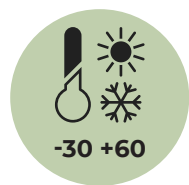

Warm and cold resistant
Resistente al caldo e al
freddo

TeraPlast™
italian beauty



*We support the love for
gardening with passion,
together with the association
Promogiardinaggio*

Sosteniamo con passione
l'amore per il verde,
assieme all'associazione
Promogiardinaggio.



made in italy

TeraPlast[™]
italian beauty

Teraplast S.p.A.

Via del Progresso, 65
36070 Castelgomberto (VI) ITALIA
Tel. +39 0445 444100
Email: info@teraplast.com

www.teraplast.com

