

2017

MADE IN ITALY

TeraPlast |
italian beauty



indice **PRODOTTI**
Index
Index
Verzeichnis



- 6 Presentazione Teraplast
10 Legenda

Intro Self Watering

- 12 Intro Self Watering

Linea Elements

- 18 Stem
20 Stalk
24 Stem luce/Stalk luce
26 Air
28 Hydral
36 Still
38 Aqua
40 Basilio
44 Kit balcone Hydral

Linea Clear

- 48 Orchidea
49 Plato Quadro
50 Porto/Plato
51 Madeira
52 Coimbra
53 Algarve

Linea Pastel

- 56 Madeira pastel
58 Estoril pastel
60 Santiago pastel

Linea Colour

- 64 Trio
66 Sunrise
68 Orchidea
70 Plato Quadro
72 Plato
74 Santiago
76 Estoril water reserve
78 Porto
82 Algarve

- 86 Madeira Luxy
88 Madeira
90 Coimbra

Linea Basic

- 94 Cilindro colour
97 Cilindro classic
98 Campana colour
99 Campana classic
100 Ciotola coste/Vaso coste
101 Ciotola con sottovaso
102 Sottovaso colour
103 Sottovaso classic
104 Quadro colour
105 Quadro classic
106 Cassettone colour
107 Cassettone classic
108 Sottovaso Quadro color/Sottovaso Quadro
109 Sottocassettone colour/Sottocassettone
110 Cassetta mare new colour
112 Cassetta mare colour
113 Cassetta mare classic
114 Cassetta Cortina colour
115 Cassetta Cortina classic
116 Cassetta Tirolo
117 Cassetta Portofino colour
118 Cassetta Portofino classic
120 Cassetta coste
121 kit balcone Coste/supporto Coste/supporto Mare
122 Sottocassetta colour
123 Sottocassetta classic

Display

- 124 Espositore Hydral
125 Espositore cilindri e sottovasi
126 Espositore cassette e sottocassette
127 Espositore cilindri/Espositore sottovasi
128 Marketingsupport

Balconiere

- 132 display kit balcone Mare 1 pz
133 display kit balcone Mare 2 pz

T-basket

- 136 T-Basket
138 T-Basket big

Linea Flortec

- 142 vaso Norma
144 vaso Container/vaso Crisa
145 vaso Basso/Gabbia verde

Linea Essential

- 148 Urban
152 Divio indoor/Corner indoor
156 Schio cassa
157 Schio cubo alto
158 Schio cubo basso
159 Schio cubo
162 Avila
164 Ribeira
166 Zamora
168 Leon
170 Standard One
172 quadro Veneto
173 cassa Veneto
174 jardinera Veneto
175 tondo Veneto
176 Schio cassa alta
177 Schio cono
178 Pasubio quadro
179 Pasubio cassa
180 Pasubio alto
182 Schio ciotola
183 Valentino/Bassano

Self Watering

- 187 Divio self watering
188 Schio cubo self watering
189 Schio cassa self watering

Linea Classic

- 192 Flora

- 193 cilindro Vicenza
194 cassetta liscia
195 quadro liscio
196 Africa/Tulipano
197 vaso festonato/vaso doppio bordo
198 campana Chiampo/cassetta Leonardo
199 cassetta millerighe/quadro millerighe
200 ciotola Castello/conca Classica
201 vaso Muro righe/vaso Muro liscio
202 sottovaso Muro/sottovaso Tondo
203 sottovaso Quadro/Sottocassetta

Linea City

- 206 New York
207 Venezia
208 Roma
209 A-Malo

Linea Luce

- 212 Standard one outdoor
213 Spritz
214 Africa outdoor
215 Tulipano outdoor
216 Valentino outdoor
217 Pasubio alto outdoor
218 Bassano outdoor
219 Schio cassa alta outdoor
220 Schio cubo alto outdoor
221 Schio cono outdoor
222 A-malo luce outdoor

Accessori

- 224 Mover
226 Fix ground round/Fix ground square
227 Fix Wall/Rotelle

Passione per la sperimentazione

Teraplast è una nuova realtà nel panorama dei vasi in plastica e si distingue per flessibilità, innovazione e gamma di prodotti. Produciamo articoli con tecnologia ad iniezione e rotazionale riuscendo a soddisfare le esigenze di settori diversificati. Inoltre possiamo realizzare, a richiesta, tutti gli articoli in una ampia gamma di colori.

Siamo in grado di soddisfare le esigenze della clientela più esigente fornendo servizi personalizzati come la progettazione e la realizzazione degli stampi, la lavorazione di materiali diversi, l'assemblaggio finale di più particolari e la realizzazione di imballi su misura.

Con la sua propensione all'innovazione, Teraplast è rientrata alla sperimentazione e alla ricerca al di là dei limiti dei materiali, delle tecnologie e delle forme, per arrivare a creare prodotti innovativi, fonti di ispirazione e di piacere alla vista.

Grazie ai suoi prodotti Teraplast continua la tradizione di eccellenza che da sempre è associata al marchio Made in Italy, riuscendo a coniugare la funzionalità del vaso e la dimensione estetica.

L'ampliamento della gamma con l'introduzione di arredi per esterni è stata la diretta conseguenza della filosofia aziendale, ed ha portato alla creazione di sedute, tavoli e lampade, reinventati per dare ad ambienti esterni la stessa ricercatezza di quelli interni.

Che si tratti di un vaso, di un tavolo geometrico o di un oggetto di design i prodotti Teraplast catturano l'attenzione e sono concepiti per essere sia funzionali che affascinanti, attestando l'eccellente capacità di lavorazione nel campo delle plastiche e dello stampaggio rotazionale.



Leidenschaft für das Experimentieren

Teraplast ist eine neue Realität in Bereich der Plastikvasen, die sich durch Flexibilität, Innovation und ihre Produktpalette absetzt. Wir produzieren unsere Produkte durch Injektions- und Rotationstechnologie und können somit die Bedürfnisse diversifizierter Bereiche zufrieden stellen. Darüber hinaus sind wir in der Lage, bei Anfrage, alle Artikel in einer weitreichenden Farbskala zu realisieren.

Mit seiner Neigung zur Innovation orientiert sich TeraPlast an das Experimentieren und an die Forschung jenseits der materialistischen, technischen und formbedingten Grenzen mit dem Ziel, innovative Produkte, Inspirationsquellen und genussvolle Anblicke zu kreieren.

Dank seiner Produkte verfolgt Teraplast weiterhin die Tradition von Exzellenz, die seit jeher mit dem Siegel Made in Italy assoziiert wird. Somit gelingt es, die Funktionalität der Vase mit der ästhetischen Dimension zu vereinen.

Der Ausbau der Produktpalette mit der Einführung der Einrichtungsgegenstände für den Außenbereich war die direkte Konsequenz der Unternehmensphilosophie. So entstanden Sitzgelegenheiten, Tische und Lampen, die neu ausgedacht wurden, um den Außenbereichen die gleiche Finesse wie den Innenbereichen zu verleihen.

Ob es sich um eine Vase, einem geometrischen Tisch oder einem Designobjekt handelt, die Produkte von TeraPlast ziehen die Aufmerksamkeit auf sich und sind so konzipiert, dass sie sowohl funktional als auch faszinierend sind.

Dies ist das Zeugnis der ausgezeichneten Fähigkeit in dem Kunststoff- und Rotationsverfahrensbereich zu operieren.

Passion for innovation

Teraplast is a new player in the plastic vase sector and stands out for its flexibility, innovation, range and particularly competitive prices. We produce articles with injection e rotational technology and we are able to satisfy the requirements of diversified sectors. In addition we can produce, on request, all the articles in a wide range of colours and sizes.

We are able to satisfy the needs of the most demanding customers providing customised services like the design and production of moulds, the process of various mediums, the final assembling of special components and provide suitable packaging.

With its inclination to innovation, Teraplast focuses on experimentation and the search beyond the limits of materials, of technologies and forms, to create innovative products that are sources of inspiration and pleasing to the eye. Thanks to its products, Teraplast goes on with the tradition of excellence that for a long time has been linked to the Made in Italy mark, succeeding in conjugating the functionality of the vase and the aesthetic dimension.

The product range expansion through the introduction of outdoor furniture has been the direct consequence of the business philosophy, and the outcome is the creation of sits, tables and lamps, redesigned to give the outdoor environment the same refinement of the interior one.

That be a vase, a geometric table or a design object, the Teraplast products capture the attention and are conceived to be both functional and fascinating, attesting the excellent ability of workmanship in the plastic field and the rotational moulding.

Passion pour l'experimentation

Teraplast est une nouvelle réalité dans le domaine des vases en plastique et se distingue par sa flexibilité, son innovation et sa gamme de produits. Nous produisons les articles avec une technologie d'injection et de rotation réussissant à satisfaire les besoins de secteurs bien diversifiés. Nous sommes également en mesure de réaliser, sur demande, tous les articles dans une large gamme de couleurs.

En mettant l'accent sur l'innovation, Teraplast est orientée vers l'expérimentation et la recherche au-delà des limites des matériaux, des technologies et des formes, pour arriver à créer des produits innovants, sources d'inspiration et de plaisir pour les yeux.

Grâce à ses produits Teraplast continue la tradition d'excellence qui a toujours été associée à la marque Made in Italy, alliant la fonctionnalité du vase à la dimension esthétique.

L'élargissement de la gamme avec l'introduction de mobiliers d'extérieur a été le conséquence directe de la philosophie d'entreprise, et a conduit à la création de sièges, tables et lampes, réinventés, pour donner aux locaux extérieurs la même finesse qu'aux locaux intérieurs.

Qu'il s'agisse d'un vase, d'une table géométrique ou d'un objet design, les produits Teraplast captent l'attention et sont conçus pour être à la fois fonctionnels et fascinants, en témoignant l'excellente capacité d'élaboration dans le domaine du plastique et du rotomoulage.





I prodotti Teraplast hanno un **animo green**, infatti sono realizzati con plastica completamente **riciclabile** e di qualità che permettono la realizzazione di prodotti **molto resistenti**, ma allo stesso tempo **leggeri** e **maneggevoli**.

Teraplast products have a „green soul“, they are produced with complete **recyclable** plastic of good quality that allows to get **very resistant** and at the same time **light** and **manageable** products.

Les produits Teraplast ont une „**âme verte**“, en effet ils sont produits avec du plastique entièrement **recyclable** et de bonne qualité qui permet la réalisation de produits très **durables**, mais en même temps **légers** et **maniabiles**.

Die Teraplast Produkte haben eine „**grüne Seele**“, sie werden mit Kunststoffmaterial hergestellt, das vollständig **wiederverwendet** werden kann und dessen Qualität die Herstellung von Produkten ermöglicht die **beständig** aber gleichzeitig **leicht** und einfach zu **handhaben** sind.



Il reparto rifinitura, il reparto di stampaggio iniezione e il nostro magazzino di 8.000 m2 sono dotati di luci led, inoltre il 19 febbraio abbiamo partecipato a **#Milluminodimeno** la più grande campagna radiofonica di sensibilizzazione sui consumi energetici e la mobilità sostenibile, ideata da Caterpillar.

The finishing department, injection molding department and our warehouse of 8.000 m2 are equipped with LED lights. On February 19th we participated at **#Milluminodimeno** the largest radio awareness campaign on energy consumption and sustainable mobility, conceived by Caterpillar.

Le département de finissage, le département de mould injecté et notre entrepôt de 8.000 m2 sont équipés de lumières LED. Le 19 Février nous avons participé à **#Milluminodimeno** la plus grande campagne de sensibilisation à la radio sur la consommation d'énergie et de la mobilité durable, conçu par Caterpillar.

Die Abteilung der Endbearbeitung, die Spritzguss-Abteilung und unser Lager von 8.000 m2 sind mit LED-Beleuchtung ausgestattet. Am 19. Februar haben wir am **#Milluminodimeno** teilgenommen, die größte Radiosensibilisierungskampagne für den Energieverbrauch und für eine umweltgerechte Mobilität, die von Caterpillar ausgedacht wurde.

I prodotti **Teraplast** hanno un **animo green**

Teraplast products have a **green soul**

Les produits **Teraplast** ont une **âme verte**

Die **Teraplast** Produkte haben eine **grüne Seele**

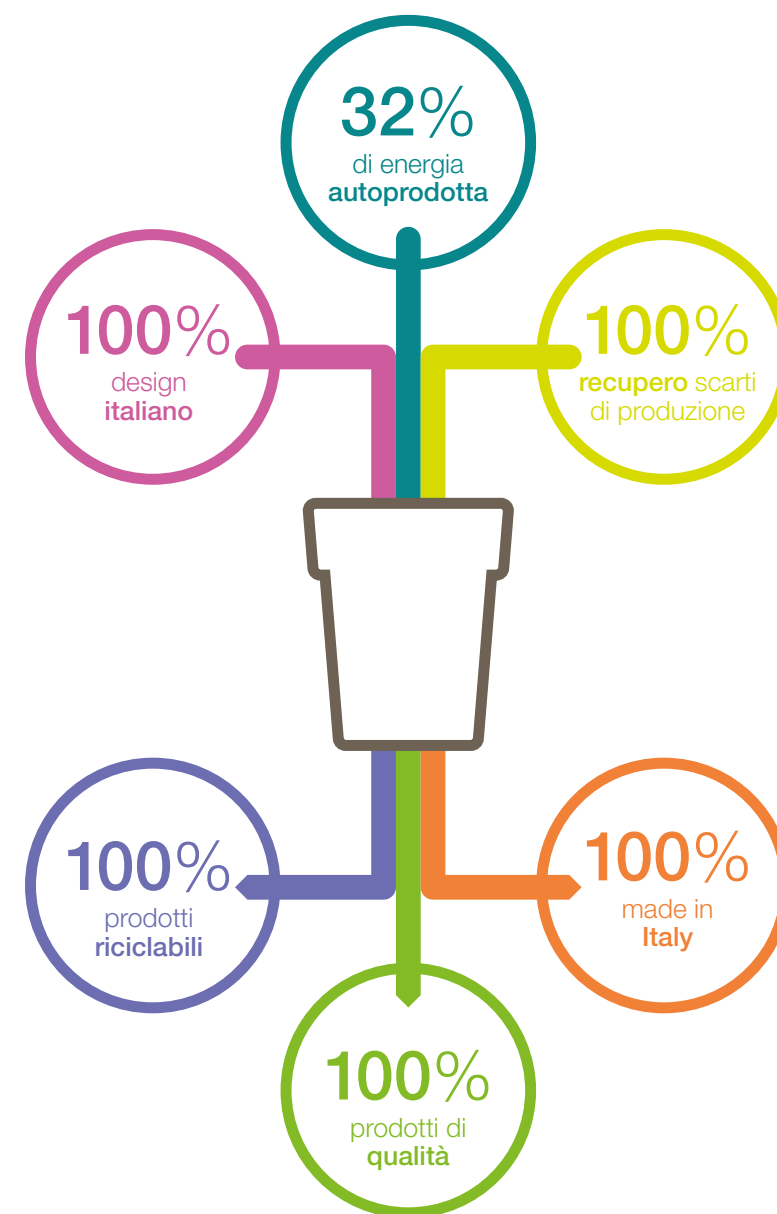

Teraplast è dotata di un impianto fotovoltaico per l'autoproduzione di energia elettrica di potenza 1017 kW che copre una superficie di 24790 m2, che permette l'autoproduzione del 32% dell'energia che ci serve per la trasformazione della materia prima.

Teraplast is equipped with a photovoltaic system, that covers an area of 24.790 m2, for the self-production of electricity of 1017 kW. This allows the self-production of 32% of the energy we need for the transformation of the raw material.

Teraplast est équipé d'un système photovoltaïque, qui couvre une superficie de 24.790 m2, pour l'autoproduction d'électricité de 1017 kW. Ça nous permet de produire 32% de l'énergie dont nous avons besoin pour la transformation de la matière première.

Teraplast ist mit einer Photovoltaik-Anlage für die Eigenproduktion von Strom von 1017 kW ausgestattet, diese umfasst eine Fläche von 24.790 m2. Dadurch wird 32% der Energie, die für die Umwandlung des Rohmaterials benötigt wird, erzeugt.

Legenda

Legenda

Légende

Legende



Superficie lucida
Glossy surface
Surface brillante
Glänzende Oberfläche

I vasi con la superficie lucida sono allegri e colorati. Si adattano facilmente al contesto creando un ambiente fresco e vivace.

Pots with glossy surface are jolly and bright. They be easily fit to the context, making the background fresh and vivid.

Les vases avec la surface brillante sont gais et colorés. Ils s'adaptent au contexte aisément en créant un milieu frais et vif.

Pflanzgefäße mit glänzender Oberfläche sind heiter und farbig. Sie richten sich nach dem Kontext und machen die Atmosphäre frisch und lebhaft.



Superficie opaca
Matt finished
Surface opaque
Matt-Oberfläche

I vasi con la superficie opaca sono eleganti e raffinati. Si prestano ad arredare i tuoi spazi con gusto e armonia.

Pots with matt surface are elegant and refined. They are fit to furnish your space with taste and harmony.

Les vases avec la surface opaque sont élégants et raffinés. Ils se prêtent à meubler vos espaces avec goût et harmonie.

Pflanzgefäße mit matter Oberfläche sind elegant und verfeinert. Ideal um Ihren Raum durch Geschmack und Harmonie auszustatten.



sottovaso / saucer
soucoupes / untersetzer



sacchetto / bag
sachets /beutel



sfuso / loose pieces
en vrac / lose Stk



display pallet



pallet di scatole
pallet of carton boxes



scatola / box
carton / karton



pallet



fix ground



fix wall



rotelle / wheels
roulettes / rollen



supporto Cassetta Coste
Iron support for Cassetta Coste
Support pour jardinière Coste
Träger für die Cassetta Coste



supporto Cassetta Mare
Iron support for Cassetta Mare
Support pour Cassetta Mare
Träger für die Cassetta Mare



SELF WATERING

Self Watering

La riserva d'acqua permette di alimentare le vostre piante senza bisogno di irrigarle spesso.

Water system allows to feed plants without needing to irrigate it often.

La réserve d'eau permet d'alimenter vos plantes sans besoin de leur irriguer souvent.

Das Wasser-Reservoir ermöglicht es, die Pflanzen zu versorgen, ohne oft zu begießen.



Facilmente lavabile
senza detersivi

Easy to wash without
detergents

Très facile à entretenir

Einfach ohne
Reinigungsmittel
waschbar



Leggerissimo

Very light

Très léger

Sehr Leicht



U.V. RESISTANT

Inalterabile nel colore

Colourfast dyes

Inalterabilité des
couleurs

Farbbeständig



-30 +60

Resistente al caldo e
al freddo

Warm and cold
resistant

Résistant à la chaleur
et au froid

Wetterfest



Sottovaso incluso
Saucer included
Soucoupe intégrée
Integrierter unterstzer



Resistente agli urti
Shock resistant
Résistant aux chocs
Stoß und Bruchfest



RECYCLABLE

Ecologico: atossico
e riciclabile

Ecological: non-toxic
and recyclable

Ecologique:
recyclable et not
toxique

Umweltfreundlich:
nicht toxisch und
recyclingsfähig

Siamo molto orgogliosi del nostro impianto fotovoltaico da 1,17 MW, posizionato sui tetti dei reparti produttivi e del magazzino, con il quale produciamo energia pulita per poter produrre i nostri vasi. Questa scelta, insieme all'utilizzo di materie prime riciclate di alta qualità e a politiche atte ad evitare sprechi in fase di imballaggio, rende Teraplast uno dei produttori di vasi più sostenibile.

We are very proud of our photovoltaic installation of 1,17 MW, placed on the roof of our production and warehouse, wherewith we produce clean energy to produce our pots. This choice, together with the use of high quality recycled raw material and strict policies to avoid wastes in the packaging process, emphasizes Teraplast as one of the most environmental friendly company.

Nous sommes très fiers de notre installation photovoltaïque de 1,17 MW, positionné sur les toits des rayons productifs et du magasin avec laquelle nous produisons énergie propre pour pouvoir produire nos vases. Avec le choix d'utiliser des matières premières recyclées de haute qualité en contribuant à la politique d'antigaspiages en phase d'emballage, Teraplast devient un des producteurs de vases les plus respectables.

Wir sind sehr stolz auf unsere Photovoltaikanlage mit 1,17 MW, auf dem Werk- und Lagerdach, womit wir saubere Energie erzeugen, um unsere Töpfe herzustellen. Diese Entscheidung, zusammen mit der Verwendung von recycelt hochwertigen Rohstoffe und ohne Verschwendungen in der Verpackungsphase, macht TeraPlast einer der am nachhaltigsten Hersteller von Pflanzgefäße.



Con
lampadina
Illuminated
Lumineux
Mit licht



Predisposto per
ruote
Prearranged for
rollers
Prévu pour roues
Vorgesehen für
Räder



Impilabile
Stackable
Impilables
Stapelbar

Per agevolare il trasporto e la vendita a scaffale molti dei nostri vasi sono impilabili.

A wide range of our pots are stockable in order to ensure easy transportation and friendly merchandising.

Pour faciliter le transport et la vente en étagères beaucoup de nos vases sont impilables.

Unsere Pflanzgefäße sind stapelbar, um den Transport und den Verkauf auf Regale zu erleichtern.



Foro predisposto
Can be drilled to
drainage
Trous de drainage
prévus
Loch Vorsatz

I vasi con il foro predisposto possono essere facilmente forabili per permettere il drenaggio dell'acqua. Una volta effettuata questa operazione si consiglia l'abbinamento con il sottovaso adeguato.

Pre drilled pots can be easily drilled to allow the drain of the water. Once done this operation we recommend to combine them with the suitable saucer.

Les vases qui ont le trou prépercé peuvent favoriser le drainage de l'eau. Une fois cette opération effectuée veuillez demander conseil au distributeur afin de trouvé le dessous de pot correspondant.

Pflanzgefäße mit vorgesehennem Loch sind einfach durchzuöchern für den Wasserdränage. Nach dem Durchlöchern ist die Benutzung des anpassenden Untersetzers zu empfehlen.

Intro Self Watering



Riserva d'acqua

La riserva d'acqua permette di alimentare le vostre piante senza bisogno di irrigarle spesso.

I fori di drenaggio per il "troppo pieno" permettono di scaricare eventuali eccessi di acqua così sarà la pianta stessa ad attingere alla riserva d'acqua quando ne avrà bisogno.

Alcuni dei vasi dotati di questo sistema presentano anche una membrana di rivestimento che, una volta rimossa, permette all'acqua in eccesso di fuoriuscire dal vaso.

Water reserve

The water reservoir allows to feed your plants without having to water it often.

The drainage holes for the "overflow" allow you to download any excess water so the plant itself will be to draw on the reserve of water when it needs them.

Some of the pots equipped with this system also have a coating membrane that, once removed, it allows excess water to leak from the pots.

Réserve d'eau

Le réservoir d'eau permet de nourrir vos plantes sans avoir à les arroser souvent. Les trous de drainage pour le «débordement» vous permettent de télécharger tout excès d'eau de sorte que sera elle-même à puiser dans la réserve d'eau quand il en aura besoin.

Certains des pots équipés de ce système ont également une membrane d'enrobage qui, une fois enlevé, permet à l'eau en excès de sortir

Wasser-Reservoir

Das Wasser-Reservoir ermöglicht, Ihre Pflanzen zu versorgen, ohne ständig Wasser zuzuführen.

Die Entwässerungslöcher lassen das Wasser überlaufen, damit die Pflanze das nach Bedarf schöpfen kann.

Einige Pflanzgefäße mit Wasserspeicher besitzen eine Abdeckung-Membrane, die das Wasser, bei Wegnahme, überlaufen lässt.

diffusione dell'acqua
per osmosi
water diffusion through
osmosis's effect
diffusion de l'eau par
osmose
Wasserdiffusion durch
Osmose

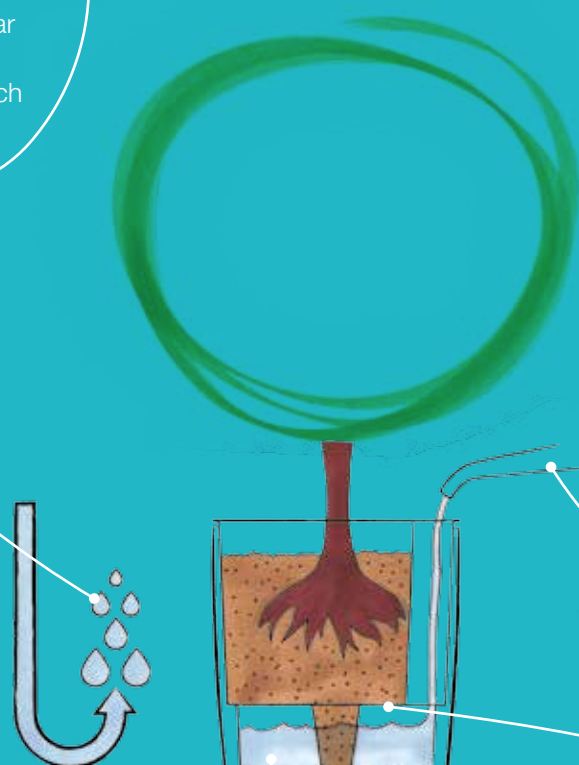

beccuccio per
inserimento dell'acqua
spout for water
insertion
bec pour l'introduction
de l'eau
Füllschacht zur
Wasserversorgung

griglia di drenaggio
drainage grid
gril pour le drainage
Bewässerungseinsatz

riserva d'acqua
water reserve
réserve d'eau
Wasser-Reservoir

Interessante? Gira
pagina e scopri
tutti!

Interesting, isn't it?
Go and find more!

Intéressant?
Blättern Sie weiter
und entdecken Sie
mehr!

Intéressant?
Tournez la page
pour en savoir plus!

Intro Self Watering



Stem
pagina 18



Stalk
pagina 20



Air
pagina 26



Hydral
pagina 28

Molti dei nostri vasi sono dotati di **riserva d'acqua**. Scopri i dettagli nelle pagine dedicate.

Most of our pots are provided with **water reserve** system. Find more details on the related pages.

Plusieurs de nos pots sont équipés de **réserve d'eau**. Découvrez les détails dans les pages dédiées.

Wir bieten viele Blumenkästen mit **Bewässerungssystem** an. Entdecken Sie die Details auf die entsprechenden Seiten.



Still
pagina 36



Aqua
pagina 38



Estoril
pagina 76



Algarve
pagina 82



Cassetta Portofino
pagina 117



Cassetta Coste
pagina 120



Divio
pagina 187



Schio Cassa
pagina 189



Schio Cubo
pagina 188



linea ELEMENTS



Stem



Stalk

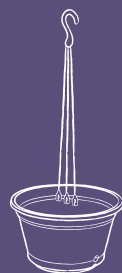

Air



Hydral



kit balcone
Hydral



Still



Aqua



Basilio

news
2017

LINEA ELEMENTS



Riserva d'acqua
Water reserve
Réserve d'eau
Wasser-Reservoir

diffusione dell'acqua per osmosi
water diffusion through osmosis's effect
diffusion de l'eau par osmose
Wasserdiffusion durch Osmose

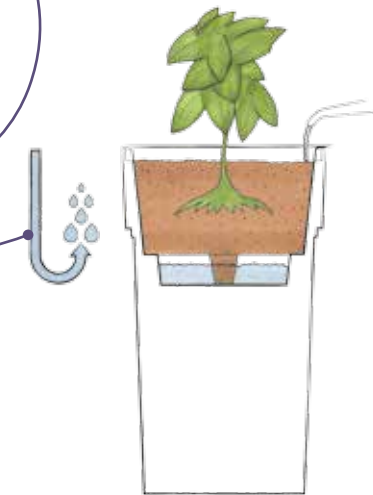

022
bianco/white
blanc/weiß



414
fog grey/ fog grey
brouillard gris/Nebel grau



406
bruno/brown
brun/braun



416
marsala/marsala
marsala /marsala



404
cedro/cedar
cèdre/zeder



005
antracite/anthracite
anthracite/anthrazitgrau

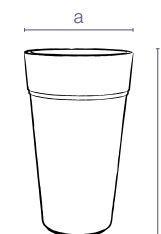

codice senza colore code without colour	Cm	dimensioni dimensions	litri liters	Confezione minima Minimum package	m ³	pezzi pallet pcs pallet	m ³
28 124 065	65	a38 b65	14	5 40x40x106h	0,17	60 80x120x229h	2,1
28 124 080	80	a38 b80	14	4 40x40x112h	0,18	48 80x120x240h	2,3

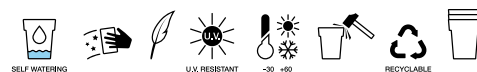

Stem

news
2017

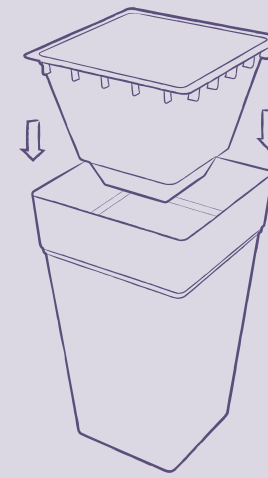

Riserva d'acqua
Water reserve
Réserve d'eau
Wasser-Reservoir

diffusione dell'acqua per osmosi
water diffusion through osmosis's effect
diffusion de l'eau par osmose
Wasserdiffusion durch Osmose

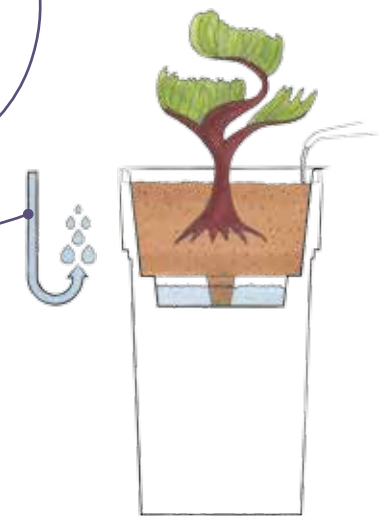

022
bianco/white
blanc/weiß



414
fog grey/ fog grey
brouillard gris/Nebel grau



406
bruno/brown
brun/braun

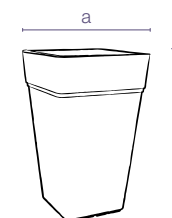

codice senza colore code without colour	Cm	dimensioni dimensions	litri liters	Confezione minima Minimum package	m ³	pezzi pallet pcs pallet	m ³
28 123 065	022 414 406	65	a38 b65 14	5 40x40x106h	0,17	60 80x120x229h	2,1
28 123 080	022 414 406	80	a38 b80 21	4 40x40x112h	0,18	48 80x120x240h	2,3

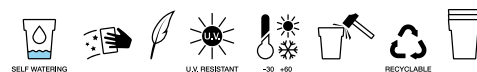

Stalk



416
marsala/marsala
marsala /marsala



404
cedro/cedar
cèdre/zeder



005
antracite/anthracite
anthracite/anthrazitgrau

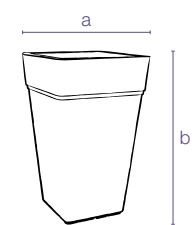

codice senza colore code without colour	Cm	dimensioni dimensions	litri liters	Confezione minima Minimum package	m ³	pezzi pallet pcs pallet	m ³
28 123 065	65	a38 b65	14	5 40x40x106h	0,17	60 80x120x229h	2,1
28 123 080	80	a38 b80	21	4 40x40x112h	0,18	48 80x120x240h	2,3

news
2017



caratteristiche lampada: attacco E27, tensione max 220, potenza max 11 W, tipo risp. energ. standard

lamp characteristics: electrical coupling E27, max voltage 220, max electrical power 11 W, standard energy saving type lamp

caractéristiques de l'ampoule: culot E27, tension max 220, puissance max 11W, type économie d'énergie standard

charakteristik der Lampe E27 Fassung, max. 220 Volt max. 11 W. Energiesparlampe Typ Standard



codice senza colore code without colour	Cm	dimensioni dimensions	litri liters	Confezione minima Minimum package	m ³	pezzi pallet pcs pallet	m ³
32 124 065	65	a38 b65	14	5 40x40x106h	0,17	60 80x120x229h	2,1
32 124 080	80	a38 b80	14	4 40x40x112h	0,18	48 80x120x240h	2,3

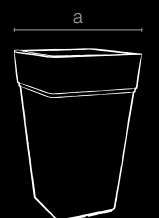

codice senza colore code without colour	Cm	dimensioni dimensions	litri liters	Confezione minima Minimum package	m ³	pezzi pallet pcs pallet	m ³
32 123 065	65	a38 b65	14	5 40x40x106h	0,17	60 80x120x229h	2,1
32 123 080	80	a38 b80	21	4 40x40x112h	0,18	48 80x120x240h	2,3

LINEA ELEMENTS



Stem e Stalk luce



news
2017



facile da appendere e con un gancio robusto
easy to hang and provided with a strong hook
facile à suspendre et muni d'un crochet solide
einfach zu hängen und mit einem stabilen Hake

codice: 03 308 050
I ganci sono disponibili anche sfusi in mazzetti da 12
Hooks are also available in packs with 12 pcs
Les crochets sont aussi disponibles dans emballages de 12 pièces
Die Haken sind los in VE von 12 Stk verfügbar



022
bianco/white
blanc/weiß



404
cedro/cedar
cèdre/zeder



406
bruno/brown
brun/braun



001
terracotta/terracotta colour
couleur terre/farbe terrakotta



005
antracite/anthracite
anthracite/anthrazitgrau

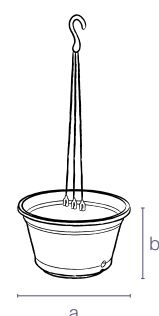

codice senza colore code without colour	Cm	dimensioni dimensions	litri liters	Confezione minima Minimum package	m ³	pezzi pallet pcs pallet	m ³
28 125 029 022 414 415 406 416 404 005	65	a28,8 b16,3	6,3	12 31x31x42h	0,04	264 80x115x115h	1,058

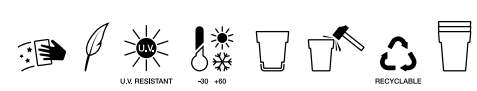

Air

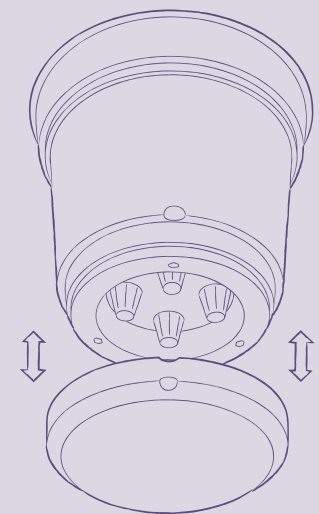

Il sottovaso è incluso e viene fissato ad incastro.
 The saucer is included and is fitted into.
 La soucoupe est inclus et est emboîtée dans.
 Der Untersetzer ist eingeschlossen und mit Clip-Funktion zusammengesteckt.

diffusione dell'acqua per osmosi
 water diffusion through osmosis's effect
 diffusion de l'eau par osmose
 Wasserdiffusion durch Osmose

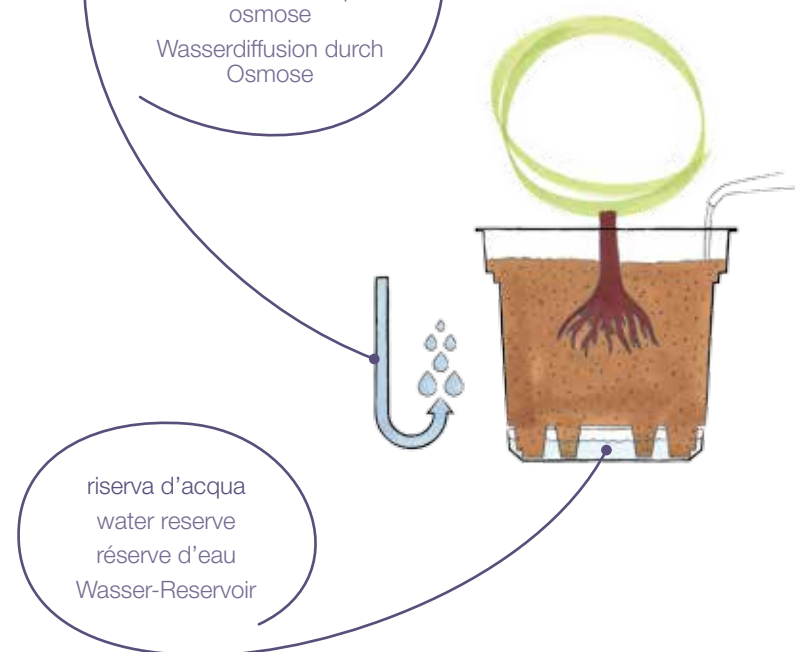

riserva d'acqua
 water reserve
 réserve d'eau
 Wasser-Reservoir



005
 antracite/anthracite
 anthracite/anthrazitgrau

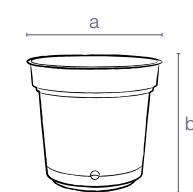

codice senza colore code without colour	Cm	dimensioni dimensions	litri liters	Confezione minima Minimum package	pezzi pallet pcs pallet	m ³
28 107 018	005 18	a18 b16	2,5	20 18x18x33h	120	0,008
28 107 023	005 23	a23 b21	5	10 23x23x43h	540	0,030
28 107 028	005 28	a28 b25	9,3	10 28x28x48h	330	0,030
28 107 033	005 33	a33 b30	15,3	10 33x33x43h	140	0,037
28 107 038	005 38	a38 b34	23	8 38x38x68h	96	0,077
28 107 048	005 48	a48 b43	46,5	4 48x48x58h	144	0,105
28 107 058	005 58	a58 b48	77	4 58x58x68h	96	0,180
28 107 068	005 68	a68 b55	120	2 68x68x60h	26	0,218
28 107 078	005 78	a78 b61	175,5	2 78x78x65h	22	0,310

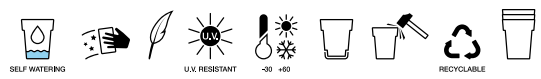

Hydral

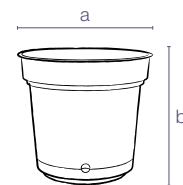

codice senza colore code without colour	Cm	dimensioni dimensions	litri liters	Confezione minima Minimum package	m ³	pezzi pallet pcs pallet	m ³
28 107 018	18	a18 b16	2,5	20 18x18x33h	0,008	120 57x50x53h	0,15
28 107 023	23	a23 b21	5	10 23x23x43h	0,030	540 80x115x115h	1,06
28 107 028	28	a28 b25	9,3	10 28x28x48h	0,030	330 80x115x115h	1,06
28 107 033	33	a33 b30	15,3	10 33x33x43h	0,037	140 80x120x120h	1,32
28 107 038	38	a38 b34	23	8 38x38x68h	0,077	96 80x115x115h	1,06
28 107 048	48	a48 b43	46,5	4 48x48x58h	0,105	144 100x115x230h	2,65
28 107 058	58	a58 b48	77	4 58x58x68h	0,180	96 100x115x220h	2,12
28 107 068	68	a68 b55	120	2 68x68x60h	0,218	26 78x78x230h	1,40
28 107 078	78	a78 b61	175,5	2 78x78x65h	0,310	22 78x78x230h	1,40



404
cedro/cedar
cèdre/zeder



022
bianco/white
blanc/weiß

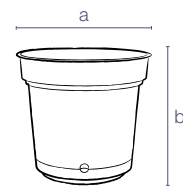

codice senza colore code without colour	Cm	dimensioni dimensions	litri liters	Confezione minima Minimum package	m ³	pezzi pallet pcs pallet	m ³
28 107 018	18	a18 b16	2,5	20 18x18x33h	0,008	120 57x50x53h	0,15
28 107 023	23	a23 b21	5	10 23x23x43h	0,030	540 80x115x115h	1,06
28 107 028	28	a28 b25	9,3	10 28x28x48h	0,030	330 80x115x115h	1,06
28 107 033	33	a33 b30	15,3	10 33x33x43h	0,037	140 80x120x120h	1,32
28 107 038	38	a38 b34	23	8 38x38x68h	0,077	96 80x115x115h	1,06
28 107 048	48	a48 b43	46,5	4 48x48x58h	0,105	144 100x115x230h	2,65
28 107 058	58	a58 b48	77	4 58x58x68h	0,180	96 100x115x220h	2,12
28 107 068	68	a68 b55	120	2 68x68x60h	0,218	26 78x78x230h	1,40
28 107 078	78	a78 b61	175,5	2 78x78x65h	0,310	22 78x78x230h	1,40



416
marsala/marsala
marsala /marsala



415
terra di Siena/terra di siena
terra di siena/terra di siena



“Cercavo un vaso di buone dimensioni dove trapiantare i pomodori. Il materiale è resistente ed è comodo il sottovaso integrato. Consiglio di mettere dell’argilla espansa sul fondo per migliorare il drenaggio dell’acqua in eccesso.”

“I was looking for a pot with good dimensions to transplant the tomatoes. The material is resistant and the integrated saucer is smart. My advice is to fill the pot with some clay pebbles to improve the drainage of the excess water.”

“Ich suchte einen großen Topf um Tomaten zu pflanzen. Das Material ist hier beständig und der integrierte Untersetzer ist praktisch. Für eine gute Drainage empfehle ich den Topfboden mit einer Blähton-schicht zu füllen.”

“Je cherchais un grand pot pour planter des tomates. Là le matériel est durable et la soucoupe intégrée est pratique. Pour le drainage de l’eau en excès je conseille de mettre de l’argile expansée sur le fond du pot.”

Sara



414
fog grey/ fog grey
brouillard gris/Nebel grau



406
bruno/brown
brun/braun

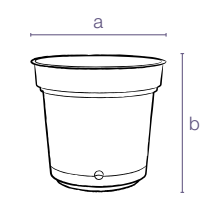

codice senza colore code without colour	Cm	dimensioni dimensions	litri liters	Confezione minima Minimum package	m ³	pezzi pallet pcs pallet	m ³
28 107 018	18	a18 b16	2,5	20 18x18x33h	0,008	120 57x50x53h	0,15
28 107 023	23	a23 b21	5	10 23x23x43h	0,030	540 80x115x115h	1,06
28 107 028	28	a28 b25	9,3	10 28x28x48h	0,030	330 80x115x115h	1,06
28 107 033	33	a33 b30	15,3	10 33x33x43h	0,037	140 80x120x120h	1,32
28 107 038	38	a38 b34	23	8 38x38x68h	0,077	96 80x115x115h	1,06
28 107 048	48	a48 b43	46,5	4 48x48x68h	0,105	144 100x115x230h	2,65
28 107 058	58	a58 b48	77	4 58x58x68h	0,180	96 100x115x220h	2,12
28 107 068	68	a68 b55	120	2 68x68x60h	0,218	26 78x78x230h	1,40
28 107 078	78	a78 b61	175,5	2 78x78x65h	0,310	22 78x78x230h	1,40

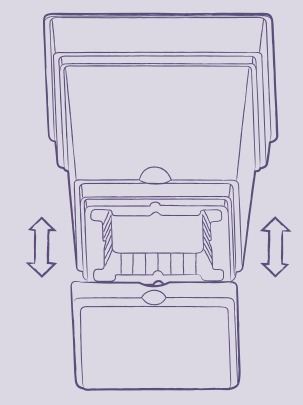

Il sottovaso è incluso e viene fissato ad incastro.
 The saucer is included and is fitted into.
 La soucoupe est inclus et est emboîtée dans.
 Der Untersetzer ist eingeschlossen und mit Clip-Funktion zusammengesteckt.

diffusione dell'acqua per osmosi
 water diffusion through osmosis's effect
 diffusion de l'eau par osmose
 Wasserdiffusion durch Osmose

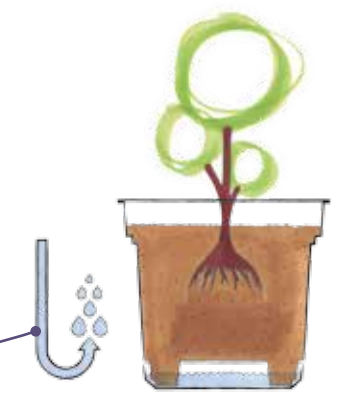

022
 bianco/white
 blanc/weiß



414
 fog grey/ fog grey
 brouillard gris/Nebel grau



415
 terra di Siena/terra di siena
 terra di siena/terra di siena



406
 bruno/brown
 brun/braun



416
 marsala/marsala
 marsala /marsala



404
 cedro/cedar
 cèdre/zeder



005
 antracite/anthracite
 anthracite/anthrazitgrau

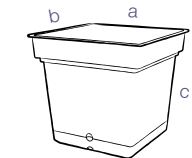

codice senza colore code without colour	Cm	dimensioni dimensions	litri liters	Confezione minima Minimum package	litri m³	pezzi pallet pcs pallet	litri m³
28 111 038	38	a38 b38 c38	29	4 38x38x47h	0,068	96 80x115x115h	1,06
28 111 047	47	a47 b47 c43	55	4 47x47x59h	0,130	128 100x115x230h	2,65

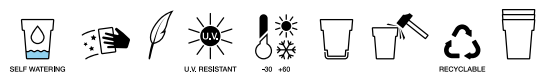

Still



LINEA ELEMENTS

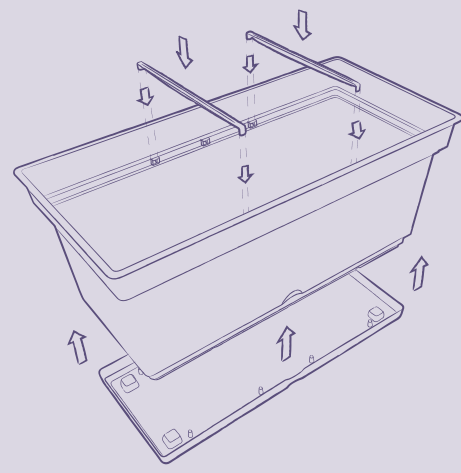

Il sottovaso e i distanziali sono inclusi e vengono fissati ad incastro.
 The saucer and the brackets are included and are fitted into.
 Der Untersetzer und die Distanzhalter sind eingeschlossen und mit Clip-Funktion zusammenbefestigt.
 La soucoupe et les espaceurs sont inclus et emboîtés.

diffusione dell'acqua per osmosi
 water diffusion through osmosis's effect
 diffusion de l'eau par osmose
 Wasserdiffusion durch Osmose



022
 bianco/white
 blanc/weiß

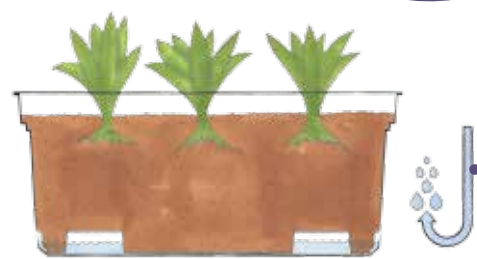

414
 fog grey/ fog grey
 brouillard gris/Nebel grau



415
 terra di Siena/terra di siena
 terra di siena/terra di siena



406
 bruno/brown
 brun/braun



416
 marsala/marsala
 marsala /marsala



404
 cedro/cedar
 cèdre/zeder



005
 antracite/anthracite
 anthracite/anthrazitgrau

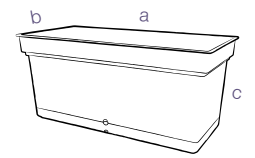

codice senza colore code without colour		Cm	dimensioni dimensions	litri liters	Confezione minima Minimum package	m ³	pezzi pallet pcs pallet	m ³
28 109 078	022 414 415 406 416 404 005	78	a78 b38 c38	66	4 78x38x47h	0,139	120 80x115x230h	2,12
28 109 098	022 414 415 406 416 404 005	98	a99 b47 c47	130	4 98x47x59h	0,272	32 100x115x120h	2,65

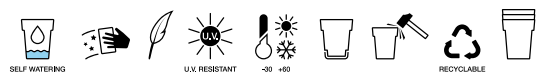

Aqua



grow
your own
veggies
at home!

adatto a:
suitable as: / adapté pour: / geeignet für:



Still cm 38
pagina 26



Aqua cm 78
pagina 26

Design by:
favaretto/partners



417
aluminium/aluminium
aluminium/aluminium

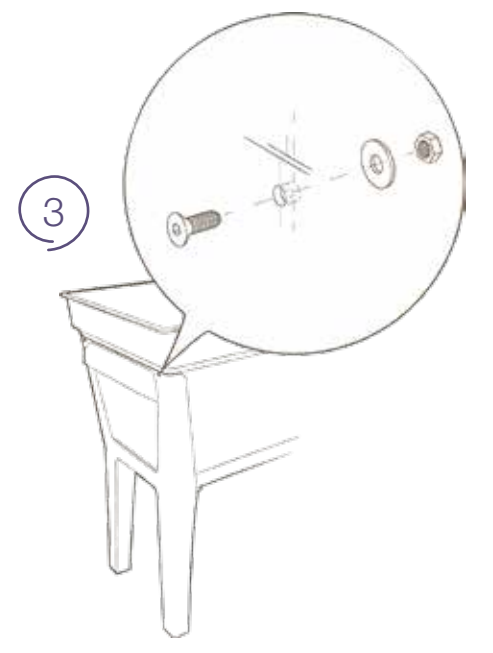
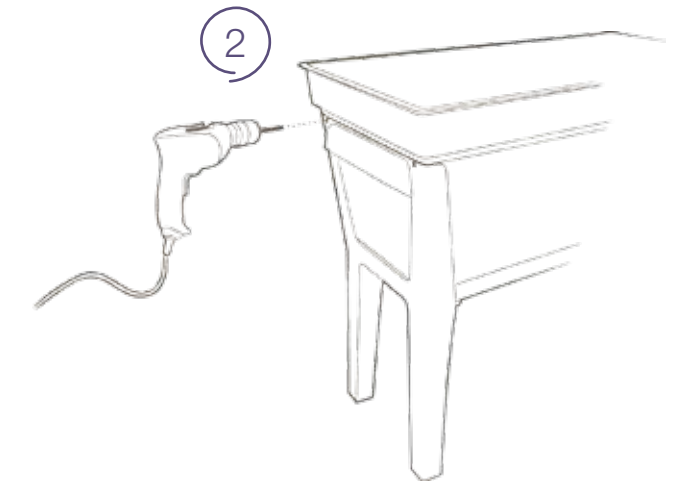
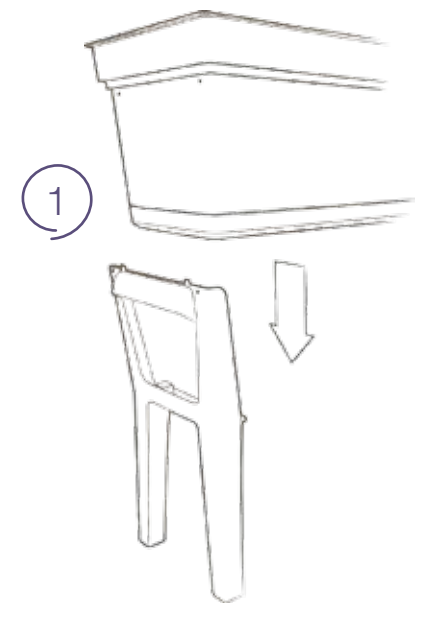

codice senza colore code without colour	Cm	dimensioni dimensions	Confezione minima Minimum package	pezzi pallet pcs pallet
28 113 061	61	a:61 b:32	62x33x25h	39 80x120x224h

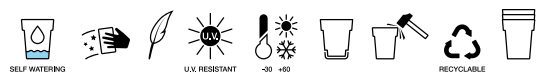

Basilio

Consigli utili

Basilio permette di prendervi cura delle vostre piante, fiori e ortaggi più comodamente.

- La scelta del terriccio è determinante per il successo del tuo orto, fatti consigliare dal rivenditore locale o l'agricoltore vicino.
- Scegli il posto giusto per il tuo basilio, considerando che l'esposizione a sud è quella ottimale.
- Semina seguendo le indicazioni di spazio e profondità indicate sulla confezione dei semi, oppure scegli delle piantine già cresciute per semplificare il lavoro.
- Annaffia le piante al tramonto o al mattino presto.
- Alcuni ortaggi producono di più se vengono raccolti spesso come fagioli, zucchine, peperoni e cetrioli.

Useful advice

Basilio allows to look after of your plants, flowers and veggies more easily.

- Soil is essential for the success of your urban garden; ask the retailer or the nearby agriculturist for a suggestion.
- Choose the best place for your Basilio, considering that facing south is the best position.
- Sow following the advice indicated on the packaging, or choose the seedlings to simplify the work.
- Water the plants at sunset or early in the morning.
- Some vegetables as beans, zucchini, peppers and cucumbers are more productive if they are harvested often.



Conseils

Basilio peut prendre soin de vos plantes, vos fleurs et vos légumes plus facilement.

- Le choix de la terre est décisif pour le succès de votre potager, faites-vous conseiller par votre commerçant ou par l'agriculteur local.
- Choisissez la bonne place pour votre Basilio, considérant que l'exposition au sud est optimale.
- Semez en suivant les indications de distance et profondeur indiquées sur l'emballage des graines ou choisissez les plants déjà développés afin de simplifier le travail.
- Arrosez les plantes le soir ou tôt le matin.
- Certains légumes produisent plus s'ils sont cueillis souvent comme les haricots, les courgettes, les poivrons et les concombres.

Empfehlungen

Basilio macht Ihre Pflege für Pflanzen, Blumen und Gemüse bequemer.

- Die richtige Gartenerde ist für den Erfolg Ihres Hochbeetes grundsätzlich, lassen Sie sich von Ihrem Fachhändler beraten.
- Wählen Sie für Ihr Basilio den richtigen Standort. Eine Ausrichtung nach Süden wäre optimal.
- Beachten Sie bei der Aussaat den Abstand und die Tiefe die auf den Samentütchen angegeben sind. Um die Arbeit zu vereinfachen können Sie auch vorkultivierte Pflanzen wählen.
- Begießen Sie die Pflanzen abends oder am frühen Morgen.
- Einige Gemüse, wie z.B. Bohnen, Zucchini, Paprika und Gurken, erzeugen mehr, wenn man sie häufig erntet.





022
bianco/white
blanc/weiß



414
fog grey/ fog grey
brouillard gris/Nebel grau



415
terra di Siena/terra di siena
terra di siena/terra di siena



406
bruno/brown
brun/braun



416
marsala/marsala
marsala /marsala



404
cedro/cedar
cèdre/zeder



005
antracite/anthracite
anthracite/anthrazitgrau

kit balcone Hydral



codice senza colore code without colour	Cm	dimensioni dimensions	pezzi pallet pcs pallet	m ³
28 130 023	23	a30 b23 c22	15 60x40x52h	0,13
			88 60x80x115h	0,55



LINEA CLEAR

linea
CLEAR



Plato Quadro



Orchidea



Porto



Plato



Madeira



Coimbra



Algarve

news
2017



Orchidea
pagina 68

news
2017

LINEA CLEAR



Plato Quadro
Pagina 70



Plato
pagina 72



disponibile nelle
misure 14 e 16
on the measures
14 and 16
dans les mesures
14 et 16
in den Größen
14 - 16

Porto
pagina 78



Madeira
pagina 86



Coimbra
pagina 90



Algarve
pagina 82

LINEA CLEAR



LINEA PASTEL

linea PASTEL



Madeira



Estoril



Santiago



412
acquamarina/aquamarine
aigue-marine/aquamarin



410
ghiaccio/ice
glace/eis



409
malva/mauve
mauve/mauve



411
porcellana/porcelain
porcelaine/porzellan

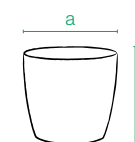

codice senza colore code without colour	Cm	dimensioni dimensions	litri liters	Confezione minima Minimum package	pezzi pallet pcs pallet	m ³	pezzi pallet pcs pallet	m ³
27 035 011	11	a11 b10	0,7	18 13x35x24h	2916	0,01	80x120x231h	2,22
27 035 014	14	a14 b12,2	1,4	18 43x29x23h	972	0,02	80x120x225h	2,16
27 035 018	18	a18 b16,2	3,3	12 57x38x23h	432	0,05	80x120x225h	2,16
27 035 022	22	a22 b19,8	6,2	8 46x24x41h	240	0,04	80x120x220h	2,11



Superficie lucida
Glossy surface
Surface brillante
Glänzende Oberfläche

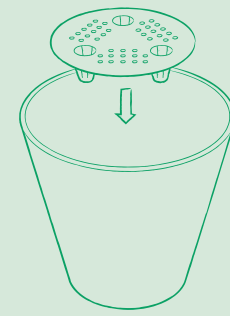
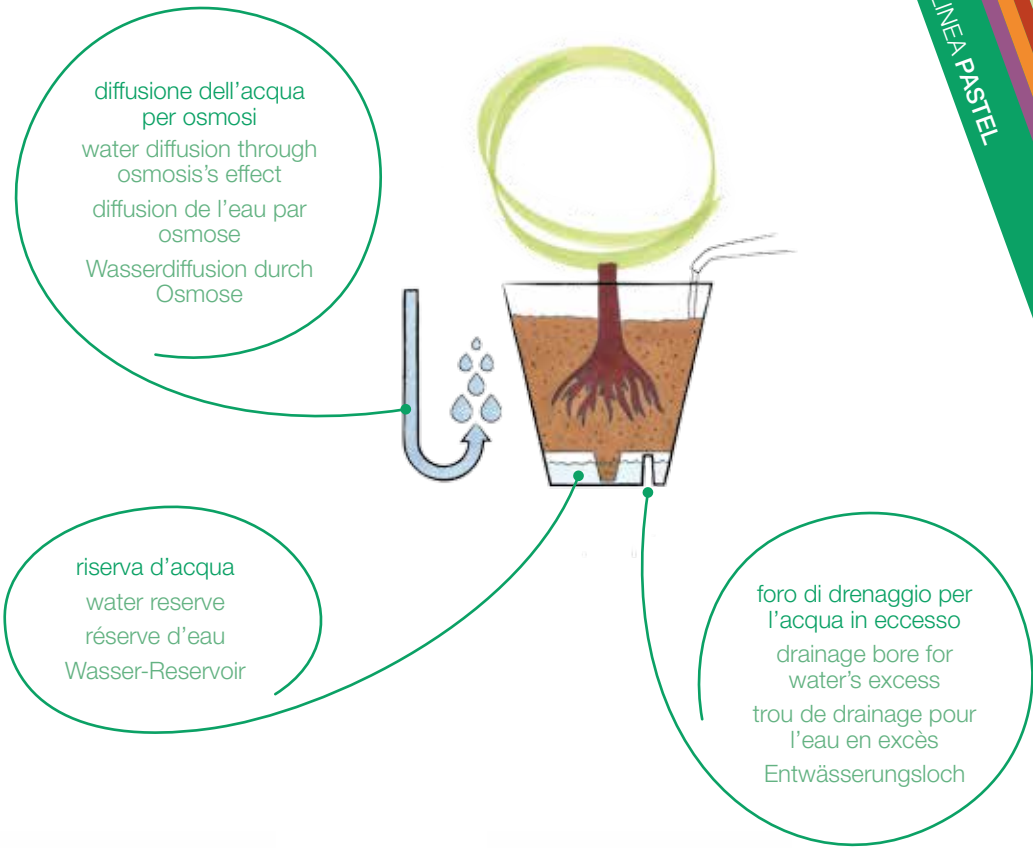

Madeira
pastel

412
acquamarina/aquamarine
aigue-marine/aquamarin



410
ghiaccio/ice
glace/eis



409
malva/mauve
mauve/mauve



411
porcellana/porcelain
porcelaine/porzellan

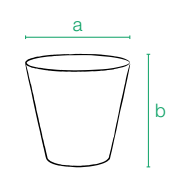

codice senza colore code without colour	Cm	dimensioni dimensions	litri liters	Confezione minima Minimum package	m ³	pezzi pallet pcs pallet	m ³
27 037 016	16	a16 b15	1,6	12 17x33x31h	0,01	1176 80x120x230h	2,2
27 037 020	20	a20 b19	3,2	8 21x21x40h	0,01	800 80x120x215h	2,1
27 037 025	25	a25 b23,5	6,2	6 26x26x44h	0,03	360 80x120x235h	2,2
27 037 030	30	a30 b28	11,8	4 31x31x39h	0,03	160 80x120x210h	2,0

Superficie lucida
Glossy surface
Surface brillante
Glänzende Oberfläche

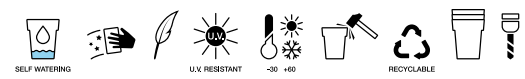

Estoril

water reserve
pastel



Superficie lucida
Glossy surface
Surface brillante
Glänzende Oberfläche



Santiago pastel

LINEA PASTEL

ideale come porta vaso
ideal as cachepot
idéal comme pot de fleurs
ideal als Übertopf

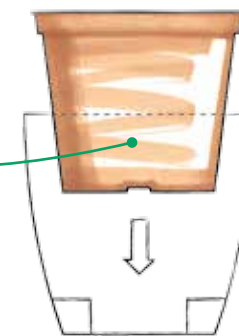

Linea Flortec
pagina 142



412

acquamarina/aquamarine
aigue-marine/aquamarin



410

ghiaccio/ice
glace/eis



409

malva/mauve
mauve/mauve



411

porcellana/porcelain
porcelaine/porzellan

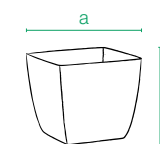

codice senza colore code without colour	Cm	dimensioni dimensions	litri liters	Confezione minima Minimum package	m ³	pezzi pallet pcs pallet	m ²
27 100 011	11	a11 b10	1	18 13x35x24h	0,01	2916 80x120x231h	2,22
27 100 013	13	a13 b12	1,5	18 15x28x36h	0,01	2160 80x120x231h	2,22
27 100 015	15	a15 b14,5	2,5	12 17x33x31h	0,01	1176 80x120x230h	2,21
27 100 020	20	a19 b17	5	8 21x21x40h	0,01	800 80x120x215h	2,06



linea
COLOUR



Sunrise



Orchidea



Plato Quadro



Plato



Santiago



Estoril



Porto

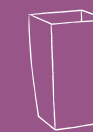

Algarve



Madeira



Coimbra

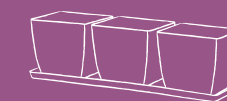

Trio Santiago



Trio Madeira

news
2017

LINEA COLOUR



022
bianco/white
blanc/weiß



401
peonia/peony
pivoine/pfingstrose



402
lilyum/lilyum
lilyum/lilyum



404
cedro/cedar
cèdre/zeder



406
bruno/brown
brun/braun



disponibile anche nella
versione con il Madeira
also available with
Madeira pots
disponible aussi avec le
pots Madeira
auch mit Madeiratöpfe
erhältlich



Trio
Santiago

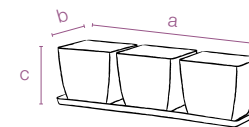

codice senza colore code without colour	Cm	dimensioni dimensions	Confezione minima Minimum package	pezzi pallet pcs pallet	m ³
08 126 035	35	a35 b11 c0,1	10 37x24x55h	0,05	200 80x120x125h 1,3

Trio
Madeira

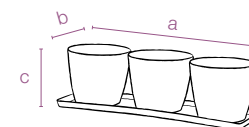

codice senza colore code without colour	Cm	dimensioni dimensions	Confezione minima Minimum package	pezzi pallet pcs pallet	m ³
08 129 035	35	a35 b11 c0,1	10 37x24x55h	0,05	200 80x120x125h 1,3



Superficie lucida
Glossy surface
Surface brillante
Glänzende Oberfläche



Trio

news
2017



022
bianco/white
blanc/weiß



401
peonia/peony
pivoine/pfingstrose



402
lilyum/lilyum
lilyum/lilyum



404
cedro/cedar
cèdre/zeder



406
bruno/brown
brun/braun



006
nero/black
noir/schwarz



Superficie lucida
Glossy surface
Surface brillante
Glänzende Oberfläche



Sunrise

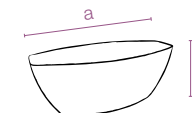

codice senza colore code without colour	Cm	dimensioni dimensions	litri liters	Confezione minima Minimum package	m ³	pezzi pallet pcs pallet	m ³
08 119 036	36	a35,8 b16,4 b14,1	5	12 57x38x23h	0,05	432 80x120x225h	2,16

news
2017



LINEA COLOUR



024
trasparente/transparent
transparent/transparent



022
bianco/white
blanc/weiß



401
peonia/peony
pivoine/pfingstrose



402
lilyum/lilyum
lilyum/lilyum



404
cedro/cedar
cèdre/zeder



406
bruno/brown
brun/braun

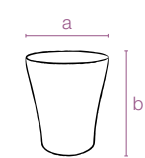

codice senza colore code without colour	Cm	dimensioni dimensions	litri liters	Confezione minima Minimum package	pezzi pallet pcs pallet	m ³	m ³
08 120 014	14	a12,5 b15,8	1,3	12 42x15x26h	384	0,015	80x60x115 0,55
08 120 016	16	a15,7 b18,6	2,2	12 48x17x30h	180	0,122	80x60x115 0,55

Superficie lucida
Glossy surface
Surface brillante
Glänzende Oberfläche

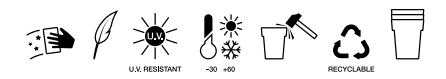

Orchidea

news
2017

LINEA COLOUR



discreto ed elegante, Plato Quadro si abbina a qualsiasi tipo di vaso, anche in terracotta

discreet and elegant, Plato Quadro combines with different types of pots, also with the ones made of terracotta

discret et élégant, Plato Quadro se combine avec différents types de pots, aussi celles en terre cuite

diskret und stilvoll, Plato Quadro passt zu verschiedenen Topfarten, auch aus Terrakotta.



024

trasparente/transparent
transparent/transparent

ideale anche come svuota tasche o porta oggetti da scrivania

Also ideal as empties pockets or holding objects by desk

Aussi idéal comme conteneur ou porte-objets au bureau

Ideal auch als Ablageschale und für den Schreibtisch

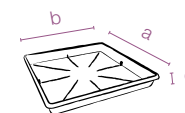

codice senza colore code without colour	Cm	dimensioni dimensions	Confezione minima Minimum package	m ³	pezzi pallet pcs pallet	m ³
08 122 027	27	a27 b27 c4	50 58X29X41h	0,07	400 80x120x100h	1,15
08 122 033	33	a33 b33 c4,2	21 34X34X41h	0,05	240 80x120x100h	1,15
08 122 038	38	a38 b38 c4,5	21 39X39X41h	0,06	240 80x120x100h	1,15



Superficie lucida
Glossy surface
Surface brillante
Glänzende Oberfläche



Plato
quadro



024
trasparente/transparent
transparent/transparent



022
bianco/white
blanc/weiß



010
rosso/red
rouge/rot



401
peonia/peony
pivoine/pfingstrose



402
lilyum/lilyum
lilyum/lilyum



028
turchese/turquoise
turquoise/türkis



404
cedro/cedar
cèdre/zeder



407
salvia/sage
sauge/salbei



406
bruno/brown
brun/braun



006
nero/black
noir/schwarz

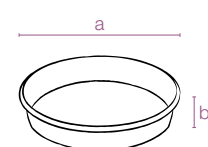

codice senza colore code without colour	Cm	dimensioni dimensions	Confezione minima Minimum package	m ³	pezzi pallet pcs pallet	m ²
08 086 012	12	a 12 b 2	18 12x12x12h	0,002	828	60x40x50h 0,12
08 086 014	14	a 14 b 2,3	18 14x14x12h	0,002	648	60x40x50h 0,12
08 086 016	16	a 16 b 2,7	12 16x16x12h	0,003	360	60x40x50h 0,12
08 086 020	20	a 20 b 3,3	8 20x20x12h	0,005	240	60x40x50h 0,12
08 086 024	24	a 24 b 4	6 24x24x12h	0,007	90	60x40x50h 0,12
08 086 028	28	a 28 b 4,7	4 28x28x12h	0,009	64	60x40x50h 0,12
08 086 032	32	a 32 b 5,2	2 32x32x8h	0,008	32	60x40x50h 0,12
08 086 036	36	a 36 b 5,2	2 36x36x8h	0,010	28	41x41x57h 0,09

Superficie lucida
Glossy surface
Surface brillante
Glänzende Oberfläche

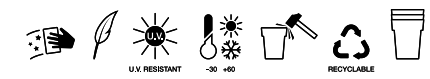

Plato



ideale come porta vaso
ideal as cachepot
idéal comme pot de fleurs
ideal als Übertopf

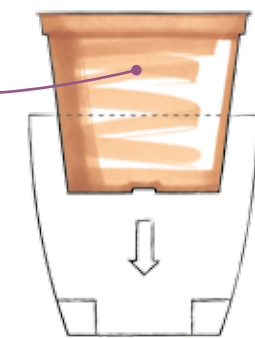

Linea Flortec
pagina 142



022
bianco/white
blanc/weiß



401
peonia/peony
pivoine/pfingstrose



402
lilyum/lilyum
lilyum/lilyum



028
turchese/turquoise
turquoise/türkis



404
cedro/cedar
cèdre/zeder



407
salvia/sage
saugé/salbei



406
bruno/brown
brun/braun



006
nero/black
noir/schwarz

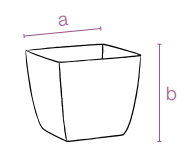

codice senza colore code without colour	Cm	dimensioni dimensions	litri liters	Confezione minima Minimum package	pezzi pallet pcs pallet	m³
08 100 011	11	a 11 b 10	1	18 13x35x24h	0,01	2916 80x120x231h 2,22
08 100 013	13	a 13 b 12	1,5	18 15x28x36h	0,01	2160 80x120x231h 2,22
08 100 015	15	a 15 b 14,5	2,5	12 17x33x31h	0,01	1176 80x120x230h 2,21
08 100 020	20	a 19 b 17	5	8 21x21x40h	0,01	800 80x120x215h 2,06

Superficie lucida
Glossy surface
Surface brillante
Glänzende Oberfläche

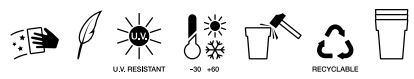

Santiago

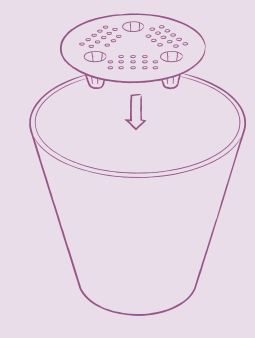

diffusione dell'acqua per osmosi
 water diffusion through osmosis's effect
 diffusion de l'eau par osmose
 Wasserdiffusion durch Osmose



riserva d'acqua
 water reserve
 réserve d'eau
 Wasser-Reservoir

foro di drenaggio per l'acqua in eccesso
 drainage bore for water's excess
 trou de drainage pour l'eau en excès
 Entwässerungsloch



022
 bianco/white
 blanc/weiß



401
 peonia/peony
 pivoine/pfingstrose



402
 lilyum/lilyum
 lilyum/lilyum



028
 turchese/turquoise
 turquoise/türkis



404
 cedro/cedar
 cèdre/zeder



407
 salvia/sage
 sauge/salbei



406
 bruno/brown
 brun/braun



006
 nero/black
 noir/schwarz



Plato
 pagina 72

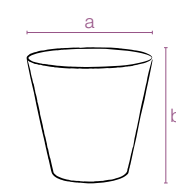

codice senza colore code without colour	Cm	dimensioni dimensions	litri liters		Confezione minima Minimum package	m ³	pezzi pallet pcs pallet	m ³
08 037 016	16	a16 b15	1,6	14	12 17x33x31h	0,01	1176 80x120x230h	2,2
08 037 020	20	a20 b19	3,2	16	8 21x21x40h	0,01	800 80x120x215h	2,1
08 037 025	25	a25 b23,5	6,2	20	6 26x26x44h	0,03	360 80x120x235h	2,2
08 037 030	30	a30 b28	11,8	24	4 31x31x39h	0,03	160 80x120x210h	2,0

Superficie lucida
 Glossy surface
 Surface brillante
 Glänzende Oberfläche

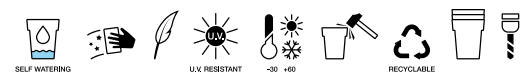

Estoril

water reserve



024
trasparente/transparent
transparent/transparent



022
bianco/white
blanc/weiß



406
bruno/brown
brun/braun



010
rosso/red
rouge/rot



401
peonia/peony
pivoine/pfingstrose



402
lilyum/lilyum
lilyum/lilyum



404
cedro/cedar
cèdre/zeder



407
salvia/sage
saugé/salbei



006
nero/black
noir/schwarz



Plato
pagina 72

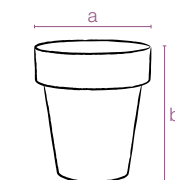

codice senza colore code without colour	Cm	dimensioni dimensions	litri liters	Confezione minima Minimum package	m ³	pezzi pallet pcs pallet	m ³			
08 083 014	14	a 14 b 15	1,3	12	18	43x15x40h	0,02	380	80x60x115h	0,55
08 083 016	16	a 16 b 17,5	2,0	14	18	50x16x41h	0,03	270	80x60x115h	0,55
08 083 020	20	a 20 b 21,5	4,0	16	12	41x21x50h	0,05	154	80x60x115h	0,55
08 083 025	25	a 25 b 27	8,0	20	8	51x26x50h	0,06	66	80x60x115h	0,55
08 083 030	30	a 30 b 32,5	14,0	24	6	61x31x52h	0,09	84	80x120x200h	1,92
08 083 035	35	a 35 b 38	23,0	28	4	36x36x41h	0,05	72	80x120x223h	2,14
08 083 040	40	a 40 b 43,5	34,0	32	2	41x41x57h	0,09	42	80x120x227h	2,18

Superficie lucida
Glossy surface
Surface brillante
Glänzende Oberfläche

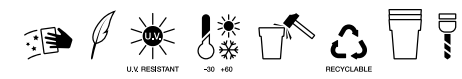

Porto



Porto



Plato



- PORTO 14 + PLATO 12
- PORTO 16 + PLATO 14
- PORTO 20 + PLATO 16
- PORTO 25 + PLATO 20
- PORTO 30 + PLATO 24
- PORTO 35 + PLATO 28
- PORTO 40 + PLATO 32



Plato
pagina 72



Porto



Ruote
wheels



Porto ha il supporto per orchidea nelle misure 14 e 16

on the measures 14 and 16 Porto is featured with **orchids's** brackets

dans les mesures 14 et 16 Porto a un support pour les **orchidées**

Unterstützung für **Orchideen** in den Größen 14 - 16 vom Topf "Porto"

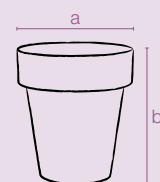
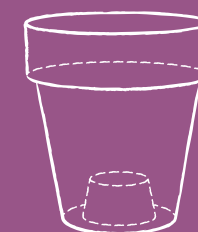

codice senza colore code without colour	Cm	dimensioni dimensions	litri liters	Confezione minima Minimum package	pezzi pallet pcs pallet
08 084 035	35	a35 b38	23,0	4 36x36x41h	72 80x120x223h
08 084 040	40	a40 b43,5	34,0	2 41x41x57h	42 80x120x227h



024
trasparente/transparent
transparent/transparent



022
bianco/white
blanc/weiß



010
rosso/red
rouge/rot



406
bruno/brown
brun/braun



404
cedro/cedar
cèdre/zeder



006
nero/black
noir/schwarz

Superficie lucida
Glossy surface
Surface brillante
Glänzende Oberfläche

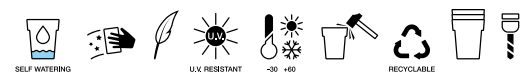

Algarve

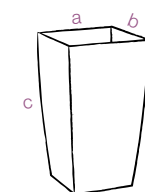

codice senza colore code without colour	Cm	dimensioni dimensions	litri liters	Confezione minima Minimum package	m ³	pezzi pallet pcs pallet	m ³
08 018 026	26	a15 b15 c26	4,4	12 46x31x36h	0,05	200 80x60x115h	0,55
08 018 035	35	a20 b20 c35	11,0	8 42x23x62h	0,06	88 80x60x115h	0,55
08 018 042	42	a25 b25 c42	20,0	4 51x26x51h	0,06	42 80x60x115h	0,55

1

Algarve

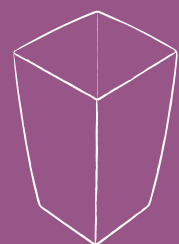

ideale per fiori recisi
ideal for cut flowers idéal
pour les fleurs coupées
ideal für Schnittblumen



Kit Algarve Water Reserve



codice senza colore code without colour	Cm	dimensioni dimensions			Confezione minima Minimum package		m ³
08 089 026	26	a 14	b 14	c 14	12	15x15x47h	0,01
08 089 035	35	a 18,5	b 18,5	c 20	8	20x20x45h	0,01
08 089 042	42	a 23,5	b 23,5	c 23	4	25x25x37h	0,02

LINEA COLOUR

2

Algarve + self watering

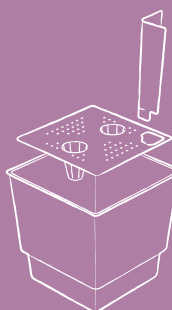
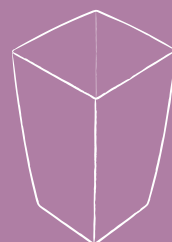

con riserva d'acqua
with water reserve system
avec réserve d'eau
mit Wasser-Reservoir

ideale come porta vaso
ideal as cachepot
idéal comme pot de fleurs
ideal als Übertopf

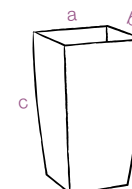

codice senza colore code without colour	Cm	dimensioni dimensions			litri liters	Confezione minima Minimum package		m ³	pezzi pallet pcs pallet		m ³
08 081 026	26	a 15	b 15	c 26	4,4	12	31x31x61h	0,05	50	80x60x115h	0,55
08 081 035	35	a 20	b 20	c 35	11,0	8	41x41x57h	0,09	44	80x60x115h	0,55
08 081 042	42	a 25	b 25	c 42	20,0	4	51x26x68h	0,09	18	80x60x115h	0,55

3

Algarve come portavaso

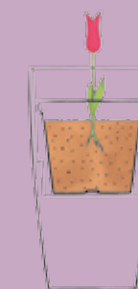
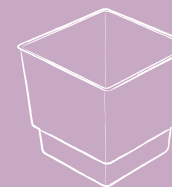
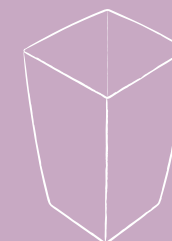

Linea Flortec
pagina 142



024
trasparente/transparent
transparent/transparent



022
bianco/white
blanc/weiß



401
peonia/peony
pivoine/pfingstrose



402
lilyum/lilyum
lilyum/lilyum



404
cedro/cedar
cèdre/zeder



407
salvia/sage
saug/salbei



406
bruno/brown
brun/braun



006
nero/black
noir/schwarz



Superficie lucida
Glossy surface
Surface brillante
Glänzende Oberfläche



Madeira
luxy

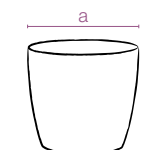

codice senza colore code without colour	Cm	dimensioni dimensions	litri liters	Confezione minima Minimum package	m ³	pezzi pallet pcs pallet	m ³
08 035 011	11	a11 b10	0,7	18 13x35x24h	0,01	2916 80x120x231h	2,22
08 035 014	14	a14 b12,2	1,4	18 43x29x23h	0,02	972 80x120x225h	2,16
08 035 018	18	a18 b16,2	3,3	12 57x38x23h	0,05	432 80x120x225h	2,16
08 035 022	22	a22 b19,8	6,2	8 46x24x41h	0,04	240 80x120x225h	2,11



022
bianco/white
blanc/weiß



016
arancio/orange
orange/orange



010
rosso/red
rouge/rot



404
cedro/cedar
cèdre/zeder



406
bruno/brown
brun/braun



006
nero/black
noir/schwarz

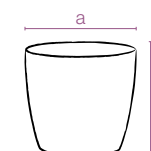

codice senza colore code without colour	Cm	dimensioni dimensions	litri liters	Confezione minima Minimum package	m ³	pezzi pallet pcs pallet	m ³
08 017 014	14	a14 b12,2	1,4	18 43x29x23h	0,02	400 80x60x115h	0,55
08 017 016	16	a16 b14,3	2,0	18 47x32x26h	0,03	304 80x60x115h	0,55
08 017 018	18	a18 b16,2	3,3	12 57x38x23h	0,05	216 80x60x115h	0,55
08 017 022	22	a22 b19,8	6,2	8 46x24x41h	0,04	104 80x60x115h	0,55
08 017 026	26	a26 b23,2	8,8	8 52x26x53h	0,07	48 80x60x115h	0,55



Superficie opaca
Matt finished
Surface opaque
Matt-Oberfläche



Madeira



ideale come porta vaso
ideal as cachepot
idéal comme pot de fleurs
ideal als Übertopf

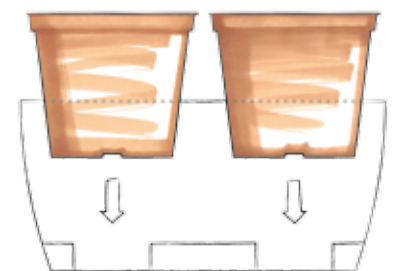

Linea Flortec
pagina 142

COIMBRA cm 30
Contiene 2 vasi da 14 cm
Suitable to contain 2 pots cm 14
Contient 2 pots de 14 cm
Platz für zwei Vasen 14 cm

COIMBRA cm 25
Contiene 2 vasi cm 12
Suitable to contain 2 pots cm 12
Contient 2 pots de 12 cm
Platz für zwei Vasen 12 cm



024
trasparente/transparent
transparent/transparent



022
bianco/white
blanc/weiß



010
rosso/red
rouge/rot



404
cedro/cedar
cèdre/zeder



406
bruno/brown
brun/braun



006
nero/black
noir/schwarz

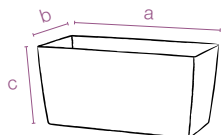

codice senza colore code without colour	Cm	dimensioni dimensions	litri liters	Confezione minima Minimum package	m ³	pezzi pallet pcs pallet	m ³
08 082 025	25	a26 b13 c12,5	4	12 28x28x34h	0,027	576 80x120x210h	2,02
08 082 030	30	a30 b15 c14	5	12 31x31x40h	0,038	432 80x120x210h	2,02

Superficie lucida
Glossy surface
Surface brillante
Glänzende Oberfläche

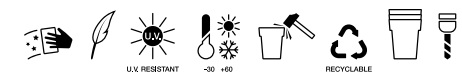

Coimbra



linea BASIC



Cilindro



Campana



Ciotola Coste



Vaso Coste



Ciotola
Con Sottovaso



Sottovaso



Quadro



Cassettone



Sottovaso
Quadro



Sottocassettone



Cassetta Mare



Cassetta Cortina



Cassetta Tirol



Cassetta
Portofino



Cassetta Coste



Sottocassetta



407
salvia/sage
sauge/salbei



409
malva/mauve
mauve/malve



415
terra di Siena/terra di siena
terra di siena/terra di siena



414
fog grey/fog grey
brouillard gris/Nebel grau



Sottovaso
pagina 102

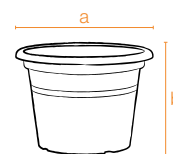

codice senza colore code without colour	Cm	dimensioni dimensions	litri liters	Confezione minima Minimum package	m ³	pezzi pallet pcs pallet	m ³
01 001 020	20	a20 b14,2	2,5	18	20 20x20x36h	0,014	1440 80x120x120h 1,15
01 001 025	25	a25 b17,7	4,8	22	10 25x25x30h	0,019	720 80x120x110h 1,06
01 001 030	30	a30 b21,2	8,5	26	10 30x30x34h	0,031	400 80x120x110h 1,06
01 001 035	35	a35 b24,6	13	30	10 35x35x39h	0,048	300 80x120x120h 1,15
01 001 040	40	a40 b27,2	19	35	10 40x40x42h	0,067	300 80x120x120h 1,15
01 001 045	45	a45 b31,4	29	40	10 45x45x46h	0,093	330 80x120x230h 2,21
01 001 050	50	a50 b34,9	41	45	5 50x50x42h	0,105	380 100x120x220h 2,64



Superficie opaca
Matt finished
Surface opaque
Matt-Oberfläche



Cilindro
colour



Superficie opaca
Matt finished
Surface opaque
Matt-Oberfläche



Cilindro colour



022

bianco/white
blanc/weiß



403

corda/cord
corde/seil



406

bruno/brown
brun/braun



408

cacao/cocoa
cacao/kakao



018

ciclamino/cyclamen
cyclamen/zyklamfarbe



019

lilla/lilac
lilas/lila



404

cedro/cedar
cèdre/zeder



Sottovaso
pagina 102

codice senza colore code without colour	Cm	dimensioni dimensions	litri liters	Confezione minima Minimum package	m ³	pezzi pallet pcs pallet	m ³
01 001 015	15	a15 b10,8	1,2	14	20	15x15x30h	0,007
01 001 018	18	a18 b12,8	2	16	20	18x18x32h	0,010
01 001 020	20	a20 b14,2	2,5	18	20	20x20x36h	0,014
01 001 025	25	a25 b17,7	4,8	22	10	25x25x30h	0,019
01 001 030	30	a30 b21,2	8,5	26	10	30x30x34h	0,031
01 001 035	35	a35 b24,6	13	30	10	35x35x39h	0,048
01 001 040	40	a40 b27,2	19	35	10	40x40x42h	0,067
01 001 045	45	a45 b31,4	29	40	10	45x45x46h	0,093
01 001 050	50	a50 b34,9	41	45	5	50x50x42h	0,105
01 001 060	60	a60 b41,8	69	52	5	60x60x50h	0,180
01 001 070	70	a70 b49	120	65	5	70x70x67h	0,328

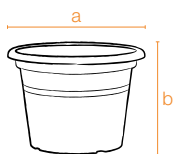

Superficie opaca
Matt finished
Surface opaque
Matt-Oberfläche



Cilindro classic



001

terracotta/terracotta colour
couleur terre/farbe terrakotta



005

antracite/anthracite
anthracite/anthrazitgrau



Sottovaso
pagina 102

codice senza colore code without colour	Cm	dimensioni dimensions	litri liters	Confezione minima Minimum package	m ³	pezzi pallet pcs pallet	m ³
01 001 015	15	a15 b10,8	1,2	14	20	15x15x30h	0,007
01 001 018	18	a18 b12,8	2	16	20	18x18x32h	0,010
01 001 020	20	a20 b14,2	2,5	18	20	20x20x36h	0,014
01 001 025	25	a25 b17,7	4,8	22	10	25x25x30h	0,019
01 001 030	30	a30 b21,2	8,5	26	10	30x30x34h	0,031
01 001 035	35	a35 b24,6	13	30	10	35x35x39h	0,048
01 001 040	40	a40 b27,2	19	35	10	40x40x42h	0,067
01 001 045	45	a45 b31,4	29	40	10	45x45x46h	0,093
01 001 050	50	a50 b34,9	41	45	5	50x50x42h	0,105
01 001 060	60	a60 b41,8	69	52	5	60x60x50h	0,180
01 001 070	70	a70 b49	120	65	5	70x70x67h	0,328
01 001 090	90	a90 b64	260	80	5	90x90x82h	0,664

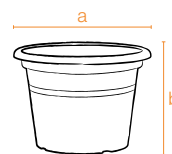



Superficie opaca
Matt finished
Surface opaque
Matt-Oberfläche



Campana colour



022
bianco/white
blanc/weiß



018
ciclamino/cyclamen
cyclamen/zyklamfarbe



019
lilla/lilac
lilas/lila



404
cedro/cedar
cèdre/zeder



Sottovaso
pagina 102

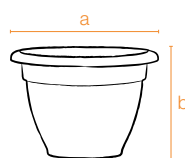

codice senza colore code without colour	Cm	dimensioni dimensions	litri liters		Confezione minima Minimum package	m³	pezzi pallet pcs pallet	m³
01 002 020	20	a20 b13,8	2,2	18	20 20x20x40h	0,01	1080 80x120x113h	1,08
01 002 025	25	a25 b17,2	4,4	22	10 25x25x33h	0,02	600 80x120x115h	1,10



Superficie opaca
Matt finished
Surface opaque
Matt-Oberfläche



Campana classic



001
terracotta/terracotta colour
couleur terre/farbe terrakotta



005
antracite/anthracite
anthracite/anthrazitgrau



Sottovaso
pagina 102

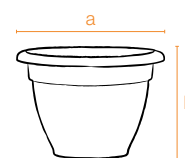

codice senza colore code without colour	Cm	dimensioni dimensions	litri liters		Confezione minima Minimum package	m³	pezzi pallet pcs pallet	m³
01 002 020	20	a20 b13,8	2,2	18	20 20x20x40h	0,01	1080 80x120x113h	1,08
01 002 025	25	a25 b17,2	4,4	22	10 25x25x33h	0,02	600 80x120x115h	1,10
01 002 030	30	a30 b20,7	7,5	26	10 30x30x37h	0,03	400 80x120x120h	1,15
01 002 035	35	a35 b24,1	12	30	10 35x35x41h	0,05	240 80x120x113h	1,08
01 002 040	40	a40 b26,8	16,5	35	10 40x40x45h	0,07	240 80x120x120h	1,15
01 002 045	45	a45 b31,1	25,5	40	10 45x45x51h	0,10	320 100x120x213h	2,56
01 002 050	50	a50 b34,6	35	45	5 50x50x45h	0,11	320 100x120x225h	2,70
01 002 060	60	a60 b41,4	60	52	5 60x60x53h	0,19	260 120x120x215h	2,58



Ciotola coste

Superficie opaca / Matt finished
Surface opaque / Matt-Oberfläche

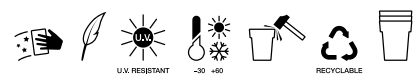

001

terracotta/terracotta colour
couleur terre/farbe terrakotta



005

antracite/anthracite
anthracite/anthrazitgrau

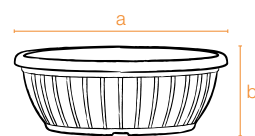

codice senza colore code without colour	Cm	dimensioni dimensions	litri liters		Confezione minima Minimum package	m ³	pezzi pallet pcs pallet	m ³
01 010 020	20	a20 b8	1,6	20	20 20x20x35h	0,01	1200	80x120x110h 1,06
01 010 025	25	a25 b9	3	26	10 25x25x25h	0,01	600	80x120x105h 1,01
01 010 030	30	a30 b11	5,2	30	10 30x30x29h	0,02	360	80x120x103h 0,99
01 010 035	35	a35 b12,5	8	35	10 35x35x31h	0,03	280	80x120x114h 1,09
01 010 040	40	a40 b14	12	40	10 40x40x38h	0,06	180	80x120x107h 1,03
01 010 050	50	a50 b18	24	52	10 50x50x43h	0,10	280	100x120x220h 2,64

Ciotola con sottovaso

Superficie opaca / Matt finished
Surface opaque / Matt-Oberfläche

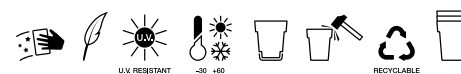

001

terracotta/terracotta colour
couleur terre/farbe terrakotta



005

antracite/anthracite
anthracite/anthrazitgrau

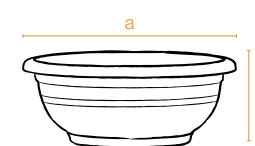

codice senza colore code without colour	Cm	dimensioni dimensions	litri liters		Confezione minima Minimum package	m ³	pezzi pallet pcs pallet	m ³
01 009 030	30	a30 b11,5	5	incl	10 30x30x25h	0,02	400	80x120x105h 1,01
01 009 040	40	a40 b15,5	11,5	incl	10 40x40x32h	0,05	240	80x120x103h 0,99
01 009 050	50	a50 b18		incl	10 50x50x38h	0,09	360	100x120x212h 2,54

Vaso coste

Superficie opaca / Matt finished
Surface opaque / Matt-Oberfläche



001

terracotta/terracotta colour
couleur terre/farbe terrakotta



005

antracite/anthracite
anthracite/anthrazitgrau

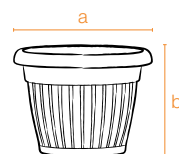

codice senza colore code without colour	Cm	dimensioni dimensions	litri liters		Confezione minima Minimum package	m ³	pezzi pallet pcs pallet	m ³
01 003 020	20	a20 b14,8	2,5	18	20 20x20x46h	0,01	1080	80x120x115h 1,10
01 003 025	25	a25 b18,4	4,9	22	10 25x25x52h	0,03	240	80x120x105h 1,01
01 003 030	30	a30 b21,8	8,4	26	10 30x30x56h	0,05	160	80x120x105h 1,01
01 003 035	35	a35 b25,7	13	30	10 35x35x59h	0,07	120	80x120x110h 1,06
01 003 040	40	a40 b29,4	20	35	10 40x40x61h	0,09	120	80x120x115h 1,10
01 003 045	45	a45 b33,1	29	40	10 45x45x64h	0,13	150	80x120x215h 2,06
01 003 050	50	a50 b36,8	40	45	5 50x50x51h	0,12	200	100x120x227h 2,72
01 003 060	60	a60 b44,1	70	52	5 60x60x58h	0,20	100	80x120x210h 2,11

gancio incluso
hook included
einschließlich Haken
crochet inclus

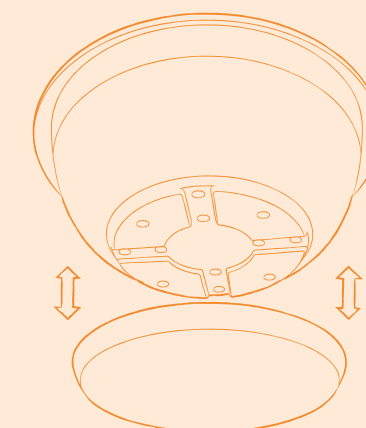

Il sottovaso è incluso e viene fissato ad incastro.

The saucer is included and is fitted into.
La soucoupe est inclus et est emboîtée dans.

Der Untersetzer ist eingeschlossen und mit Clip-Funktion zusammengesteckt.

Sottovaso colour

Superficie opaca / Matt finished
Surface opaque / Matt-Oberfläche

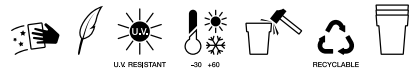

022
bianco/white
blanc/weiß



403
corda/cord
corde/seil



406
bruno/brown
brun/braun



408
cacao/cocoa
cacao/kakao



018
ciclamino/cyclamen
cyclamen/zyklamfarbe



019
lilla/lilac
lilas/lila



404
cedro/cedar
cèdre/zeder



407
salvia/sage
sauge/salbei



409
malva/mauve
mauve/malve



415
terra di Siena/terra di siena
terra di siena/terra di siena



414
fog grey/fog grey
brouillard gris/Nebel grau

codice senza colore code without colour	Cm	dimensioni dimensions	Confezione minima Minimum package	m ³	pezzi pallet pcs pallet	m ³
01 011 014	14	a14 b1,8	100	14x14x32h	0,006	2200
01 011 016	16	a16 b1,9	100	16x16x32h	0,008	1400
01 011 018	18	a18 b2,3	100	18x18x32h	0,010	1200
01 011 022	22	a22 b3	50	22x22x24h	0,012	500
01 011 026	26	a26 b3,7	50	26x26x24h	0,016	300
01 011 030	30	a30 b4,1	25	30x30x15h	0,014	200
01 011 035	35	a35 b5,1	25	35x35x15h	0,018	125
01 011 040	40	a40 b5,2	25	40x40x15h	0,024	125
01 011 045	45	a45 b5,5	25	45x45x17h	0,034	600
01 011 052	52	a52 b6,6	25	52x52x19h	0,051	350
01 011 066	66	a66 b6	5	66x66x9h	0,039	130

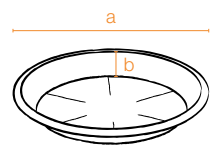

Sottovaso classic

Superficie opaca / Matt finished
Surface opaque / Matt-Oberfläche

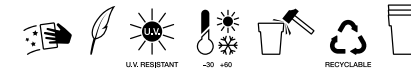

001
terracotta/terracotta colour
couleur terre/farbe terrakotta



005
antracite/anthracite
anthracite/anthrazitgrau

codice senza colore code without colour	Cm	dimensioni dimensions	Confezione minima Minimum package	m ³	pezzi pallet pcs pallet	m ³
01 011 012	12	a12 b1,5	100	12x12x28h	0,004	2800
01 011 014	14	a14 b1,8	100	14x14x32h	0,006	2200
01 011 016	16	a16 b1,9	100	16x16x32h	0,008	1400
01 011 018	18	a18 b2,3	100	18x18x32h	0,010	1200
01 011 020	20	a20 b2,9	50	20x20x20h	0,008	700
01 011 022	22	a22 b3	50	22x22x24h	0,012	500
01 011 024	24	a24 b3,6	50	24x24x20h	0,012	450
01 011 026	26	a26 b3,7	50	26x26x24h	0,016	300
01 011 028	28	a28 b4,1	50	28x28x24h	0,019	300
01 011 030	30	a30 b4,1	25	30x30x15h	0,014	200
01 011 035	35	a35 b5,1	25	35x35x15h	0,018	125
01 011 040	40	a40 b5,2	25	40x40x15h	0,024	125
01 011 045	45	a45 b5,5	25	45x45x17h	0,034	600
01 011 052	52	a52 b6,6	25	52x52x19h	0,051	350
01 011 065	65	a65 b6	5	65x65x9h	0,039	130
01 011 080	80	a80 b6,6	5	80x80x10h	0,077	130

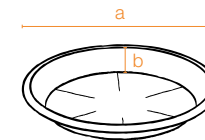



Superficie opaca
Matt finished
Surface opaque
Matt-Oberfläche



Superficie opaca
Matt finished
Surface opaque
Matt-Oberfläche



Quadro colour



403
corda/cord
corde/seil



406
bruno/brown
brun/braun



408
cacao/cocoa
cacao/kakao



Sottovaso
pagina 108

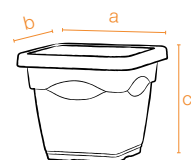

codice senza colore code without colour	Cm	dimensioni dimensions	litri liters		Confezione minima Minimum package	m ³	pezzi pallet pcs pallet	m ³
01 007 032	32	a32 b32 c28	14	27	10 32x32x49h	0,05	210 80x120x115h	1,10
01 007 038	38	a38 b38 c33,5	25	33	10 38x38x56h	0,08	180 80x120x110h	1,06
01 007 045	45	a45 b45 c40	42	38	10 45x45x69h	0,14	200 100x120x212h	2,54

Quadro classic



001
terracotta/terracotta colour
couleur terre/farbe terrakotta



005
antracite/anthracite
anthracite/anthrazitgrau



Sottovaso
pagina 108

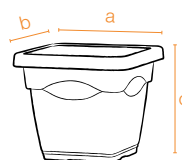

codice senza colore code without colour	Cm	dimensioni dimensions	litri liters		Confezione minima Minimum package	m ³	pezzi pallet pcs pallet	m ³
01 007 032	32	a32 b32 c28	14	27	10 32x32x49h	0,05	210 80x120x115h	1,10
01 007 038	38	a38 b38 c33,5	25	33	10 38x38x56h	0,08	180 80x120x110h	1,06
01 007 045	45	a45 b45 c40	42	38	10 45x45x69h	0,14	200 100x120x212h	2,54





Superficie opaca
Matt finished
Surface opaque
Matt-Oberfläche



Superficie opaca
Matt finished
Surface opaque
Matt-Oberfläche



Cassettone colour

Cassettone classic



403

corda/cord
corde/seil



406

bruno/brown
brun/braun



001

terracotta/terracotta colour
couleur terre/farbe terrakotta



005

antracite/anthracite
anthracite/anthrazitgrau



408

cacao/cocoa
cacao/kakao

Sottocassettone
pagina 109



Sottocassettone
pagina 109

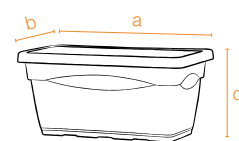

codice senza colore code without colour	Cm	dimensioni dimensions		litri liters		Confezione minima Minimum package	m ³	pezzi pallet pcs pallet		m ³
01 008 060	60	a60	b32	c27,5	31	60	5 60x32x37h	0,07	420	100x120x224h 2,69
01 008 080	80	a80	b37	c32,8	60	80	5 80x37x43h	0,12	210	80x120x224h 2,15
01 008 100	100	a100	b40	c37,5	92	100	5 100x40x54h	0,21	100	100x120x228h 2,74

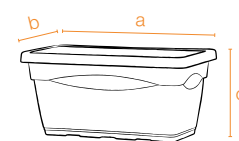

codice senza colore code without colour	Cm	dimensioni dimensions		litri liters		Confezione minima Minimum package	m ³	pezzi pallet pcs pallet		m ³
01 008 060	60	a60	b32	c27,5	31	60	5 60x32x37h	0,07	420	100x120x224h 2,69
01 008 080	80	a80	b37	c32,8	60	80	5 80x37x43h	0,12	210	80x120x224h 2,15
01 008 100	100	a100	b40	c37,5	92	100	5 100x40x54h	0,21	100	100x120x228h 2,74



Sottovaso Quadro

colour

Superficie opaca / Matt finished
Surface opaque / Matt-Oberfläche

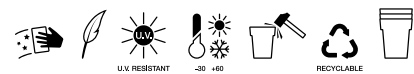

403
corda/cord
corde/seil



406
bruno/brown
brun/braun



408
cacao/cocoa
cacao/kakao

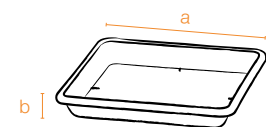

codice senza colore code without colour	Cm	dimensioni dimensions	Confezione minima Minimum package	m³	pezzi pallet pcs pallet	m³
01 013 027	27	a27 b4	10 27x27x11h	0,01	140 60x40x50h	0,12
01 013 033	33	a33 b5	10 33x33x13h	0,01	70 60x40x50h	0,12
01 013 038	38	a37,5 b6	10 38x38x16h	0,02	50 60x40x50h	0,12

Sottocassettone

colour

Superficie opaca / Matt finished
Surface opaque / Matt-Oberfläche

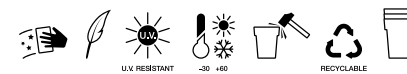

403
corda/cord
corde/seil



406
bruno/brown
brun/braun



408
cacao/cocoa
cacao/kakao

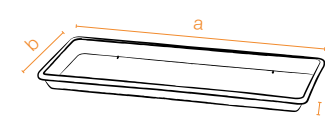

codice senza colore code without colour	Cm	dimensioni dimensions	Confezione minima Minimum package	m³	pezzi pallet pcs pallet	m³
01 014 060	60	a56 b28 c4,3	5 56x28x7h	0,01	60 60x40x50h	0,12
01 014 080	80	a75 b32 c5,1	5 75x33x9h	0,02	285 80x120x115h	1,10
01 014 100	100	a95 b35 c5,2	5 95x35x11h	0,03	160 80x120x115h	1,10

Sottovaso Quadro

Superficie opaca / Matt finished
Surface opaque / Matt-Oberfläche

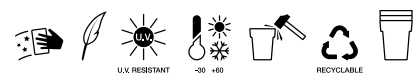

001
terracotta/terracotta colour
couleur terre/farbe terrakotta



005
antracite/anthracite
anthracite/anthrazitgrau

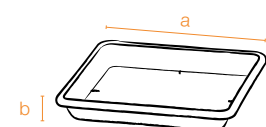

codice senza colore code without colour	Cm	dimensioni dimensions	Confezione minima Minimum package	m³	pezzi pallet pcs pallet	m³
01 013 027	27	a27 b4	10 27x27x11h	0,01	140 60x40x50h	0,12
01 013 033	33	a33 b5	10 33x33x13h	0,01	70 60x40x50h	0,12
01 013 038	38	a37,5 b6	10 38x38x16h	0,02	50 60x40x50h	0,12

Sottocassettone

Superficie opaca / Matt finished
Surface opaque / Matt-Oberfläche

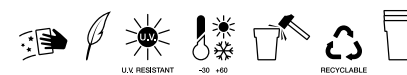

001
terracotta/terracotta colour
couleur terre/farbe terrakotta



005
antracite/anthracite
anthracite/anthrazitgrau

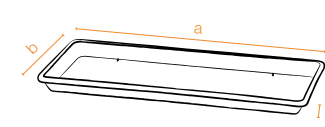

codice senza colore code without colour	Cm	dimensioni dimensions	Confezione minima Minimum package	m³	pezzi pallet pcs pallet	m³
01 014 060	60	a56 b28 c4,3	5 56x28x7h	0,01	60 60x40x50h	0,12
01 014 080	80	a75 b32 c5,1	5 75x33x9h	0,02	285 80x120x115h	1,10
01 014 100	100	a95 b35 c5,2	5 95x35x11h	0,03	160 80x120x115h	1,10



Cassetta mare colour



Superficie opaca
Matt finished
Surface opaque
Matt-Oberfläche

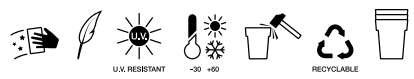

407
salvia/sage
sauge/salbei



409
malva/mauve
mauve/malve



415
terra di Siena/terra di siena
terra di siena/terra di siena



414
fog grey/fog grey
brouillard gris/Nebel grau



Sottocassetta
pagina 122

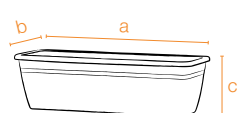

codice senza colore code without colour	Cm	dimensioni dimensions	litri liters	Confezione minima Minimum package	litri liters	pezzi pallet pcs pallet	accessori accessories
01 004 040	40	a:40 b:17 c:14,5	6	10 40x17x30h	0,02	700 80x120x115h	1,10
01 004 050	50	a:50 b:17 c:14,5	8	10 50x17x30h	0,02	450 80x120x118h	1,13
01 004 060	60	a:60 b:17 c:14,5	10	10 60x17x30h	0,03	450 80x120x115h	1,10



Superficie opaca
Matt finished
Surface opaque
Matt-Oberfläche



Cassetta mare colour



022
bianco/white
blanc/weiß



403
corda/cord
corde/seil



406
bruno/brown
brun/braun



408
cacao/cocoa
cacao/kakao



018
ciclamo/cyclamen
cyclamen/zyklamfarbe



019
lilla/lilac
lilas/lila



404
cedro/cedar
cèdre/zeder



Sottocassetta
pagina 122

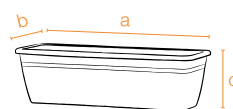

supporto mare
pagina 121

codice senza colore code without colour	Cm	dimensioni dimensions	litri liters	Confezione minima Minimum package	pezzi pallet pcs pallet	accessori accessories
01 004 040	40	a40 b17 c14,5	6	10 40x17x30h	700 80x120x115h	1,10
01 004 050	50	a50 b17 c14,5	8	10 50x17x30h	450 80x120x118h	1,13
01 004 060	60	a60 b17 c14,5	10	10 60x17x30h	450 80x120x115h	1,10
01 004 080	80	a80 b17 c14,5	12	10 80x17x30h	240 80x120x105h	1,01



Superficie opaca
Matt finished
Surface opaque
Matt-Oberfläche



Cassetta mare classic



001
terracotta/terracotta colour
couleur terre/farbe terracotta



005
antracite/anthracite
anthracite/anthrazitgrau



Sottocassetta
pagina 122

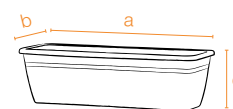

supporto mare
pagina 121

codice senza colore code without colour	Cm	dimensioni dimensions	litri liters	Confezione minima Minimum package	pezzi pallet pcs pallet	accessori accessories
01 004 040	40	a40 b17 c14,5	6	10 40x17x30h	700 80x120x115h	1,10
01 004 050	50	a50 b17 c14,5	8	10 50x17x30h	450 80x120x118h	1,13
01 004 060	60	a60 b17 c14,5	10	10 60x17x30h	450 80x120x115h	1,10
01 004 080	80	a80 b17 c14,5	12	10 80x17x30h	240 80x120x105h	1,01





Superficie opaca
Matt finished
Surface opaque
Matt-Oberfläche



Superficie opaca
Matt finished
Surface opaque
Matt-Oberfläche



Cassa Cortina colour

Cassetta Cortina classic



022
bianco/white
blanc/weiß



406
bruno/brown
brun/braun



018
ciclamino/cyclamen
cyclamen/zyklamfarbe



404
cedro/cedar
cèdre/zeder



Sottocassetta
pagina 122



001
terracotta/terracotta colour
couleur terre/farbe terrakotta



005
antracite/anthracite
anthracite/anthrazitgrau



Sottocassetta
pagina 122

codice senza colore code without colour	Cm	dimensioni dimensions	litri liters	Confezione minima Minimum package	m ³	pezzi pallet pcs pallet	m ³
01 104 040	40	a40 b18 c14	10	5 40x18x22h	0,01	480 80x120x106h	1,08
01 104 060	60	a60 b18 c14	15	5 60x18x22h	0,02	320 80x120x106h	1,08
01 104 080	80	a80 b18 c14	20	5 80x18x22h	0,03	240 80x120x106h	1,08
01 104 100	100	a100 b18 c14	25	5 100x18x22h	0,04	160 80x120x106h	1,08

codice senza colore code without colour	Cm	dimensioni dimensions	litri liters	Confezione minima Minimum package	m ³	pezzi pallet pcs pallet	m ³
01 104 040	40	a40 b18 c14	10	5 40x18x22h	0,01	480 80x120x106h	1,08
01 104 060	60	a60 b18 c14	15	5 60x18x22h	0,02	320 80x120x106h	1,08
01 104 080	80	a80 b18 c14	20	5 80x18x22h	0,03	240 80x120x106h	1,08
01 104 100	100	a100 b18 c14	25	5 100x18x22h	0,04	160 80x120x106h	1,08

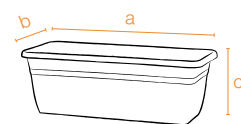
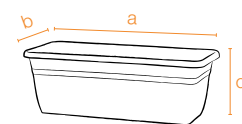

Cassetta Tirol

Superficie opaca / Matt finished
Surface opaque / Matt-Oberfläche

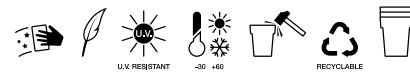

“La cassetta Tirol contiene davvero tanta terra e riesco a coltivare molte varietà di piante.”
 “The balcony box Tirol really contains a lot of compost so I can cultivate many plant varieties”
 “La jardinière Tirol contient beaucoup de terre et je peux cultiver toute variété de plantes”
 “Der Blumenkasten Tirol enthält wirklich viel Erde und ich kann viele Pflanzensorten züchten.”

Linda



001

terracotta/terracotta colour
couleur terre/farbe terrakotta



005

antracite/anthracite
anthracite/anthrazitgrau



Sottocassetta
pagina 122

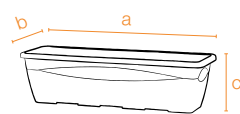

codice senza colore code without colour	Cm	dimensioni dimensions	litri liters	Confezione minima Minimum package	m ³	pezzi pallet pcs pallet	m ³
01 006 040	40	a40 b20 c16	8	40	10	40x20x31h	0,02
01 006 050	50	a50 b20 c16	10,5	50	10	50x20x31h	0,03
01 006 060	60	a60 b20 c16	13	60	10	60x20x31h	0,03



Superficie opaca
Matt finished
Surface opaque
Matt-Oberfläche

Cassetta Portofino colour



022

bianco/white
blanc/weiß



406

bruno/brown
brun/braun



018

ciclamino/cyclamen
cyclamen/zyklamfarbe



404

cedro/cedar
cèdre/zeder



mesure 80 - 100
sizes 80 - 100

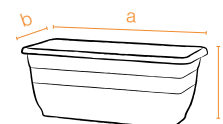

codice senza colore code without colour	Cm	dimensioni dimensions	litri liters	Confezione minima Minimum package	m ³	pezzi pallet pcs pallet	m ³
01 105 040	40	a40 b20 c16,5	13	5	40x20x32h	0,02	240 80x120x110h 1,06
01 105 060	60	a60 b20 c16,5	20	5	60x20x32h	0,03	160 80x120x110h 1,06
01 105 080	80	a80 b20 c16,5	26	5	80x20x32h	0,05	120 80x120x110h 1,06
01 105 100	100	a100 b20 c16,5	33	5	100x20x32h	0,06	80 80x120x110h 1,06





Superficie opaca
Matt finished
Surface opaque
Matt-Oberfläche



Cassetta Portofino classic



001
terracotta/terracotta colour
couleur terre/farbe terrakotta



005
antracite/anthracite
anthracite/anthrazitgrau

misure 80 - 100
sizes 80 - 100

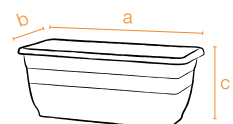

codice senza colore code without colour	Cm	dimensioni dimensions			litri liters	Confezione minima Minimum package	m ³	pezzi pallet pcs pallet	m ³
01 105 040	40	a40	b20	c16,5	13	5 40x20x32h	0,02	240 80x120x110h	1,06
01 105 060	60	a60	b20	c16,5	20	5 60x20x32h	0,03	160 80x120x110h	1,06
01 105 080	80	a80	b20	c16,5	26	5 80x20x32h	0,05	120 80x120x110h	1,06
01 105 100	100	a100	b20	c16,5	33	5 100x20x32h	0,06	80 80x120x110h	1,06

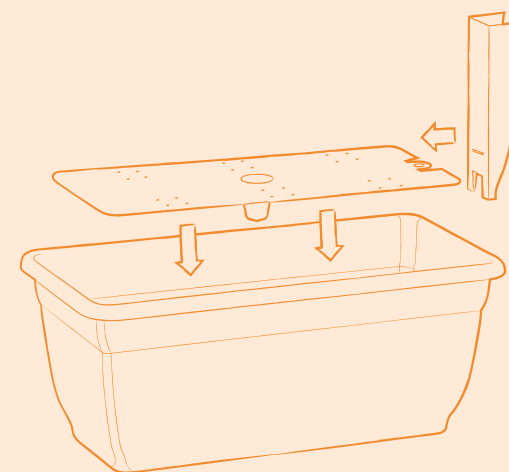

diffusione dell'acqua per osmosi
water diffusion through osmosis's effect
diffusion de l'eau par osmose
Wasserdiffusion durch Osmose

beccuccio per inserimento dell'acqua
spout for water insertion
bec pour l'introduction de l'eau
Füllschacht zur Wasserversorgung

foro di drenaggio per l'acqua in eccesso
drainage bore for water's excess
trou de drainage pour l'eau en excès
Entwässerungsloch

riserva d'acqua
water reserve
réserve d'eau
Wasser-Reservoir

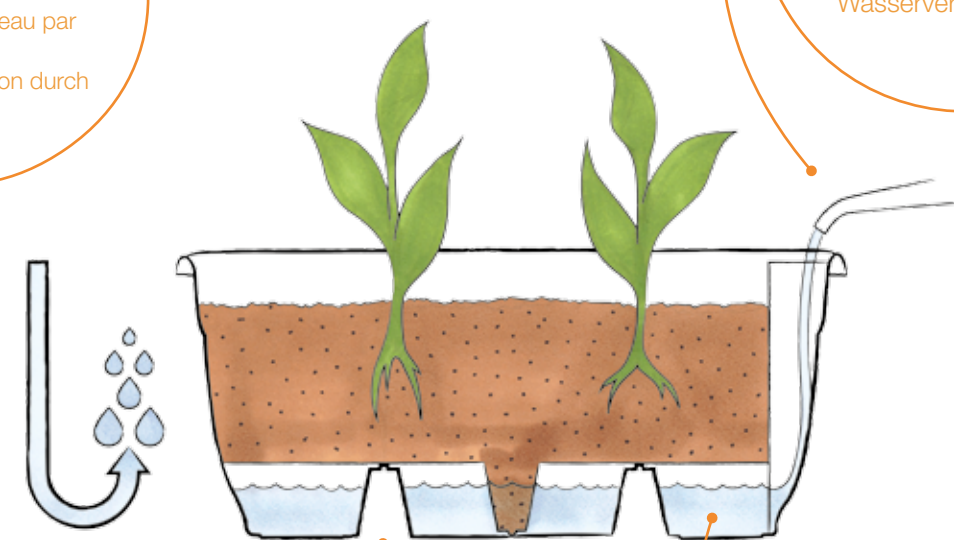

- SELF WATERING
- WATERING
- LEAF
- UV RESISTANT
- WATER
- RECYCLABLE

Cassetta Coste

Superficie opaca / Matt finished
Surface opaque / Matt-Oberfläche

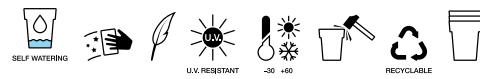

001
terracotta/terracotta colour
couleur terre/farbe terrakotta



005
antracite/anthracite
anthracite/anthrazitgrau

diffusione dell'acqua per osmosi
water diffusion through osmosis's effect
diffusion de l'eau par osmose
Wasserdiffusion durch Osmose

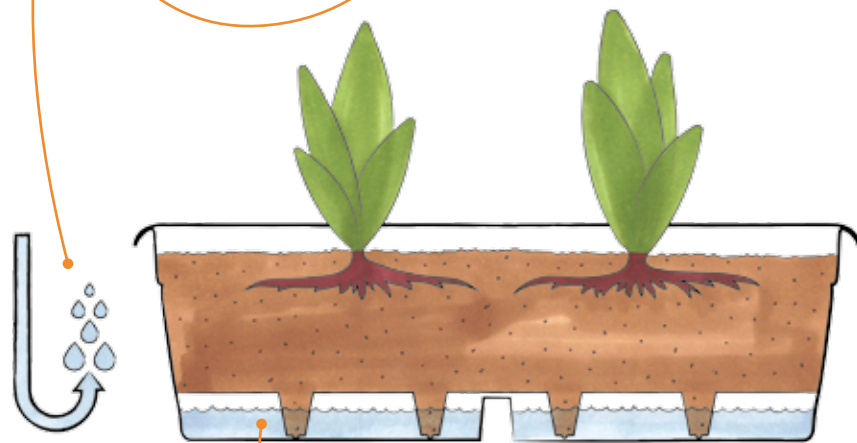

riserva d'acqua
water reserve
réserve d'eau
Wasser-Reservoir

supporto coste
pagina 121

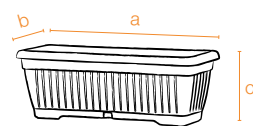

codice senza colore code without colour	Cm	dimensioni dimensions	litri liters	Confezione minima Minimum package	pezzi pallet pcs pallet	accessori accessories
01 005 040	40	a40 b20 c17	8	10 40x20x43h	0,03 360 80x120x115h	1,10
01 005 050	50	a50 b20 c17	10,5	10 50x20x43h	0,04 270 80x120x115h	1,10
01 005 060	60	a60 b20 c17	13	10 60x20x43h	0,05 240 80x120x118h	1,13

kit balcone Coste

Superficie opaca / Matt finished
Surface opaque / Matt-Oberfläche

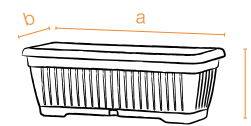
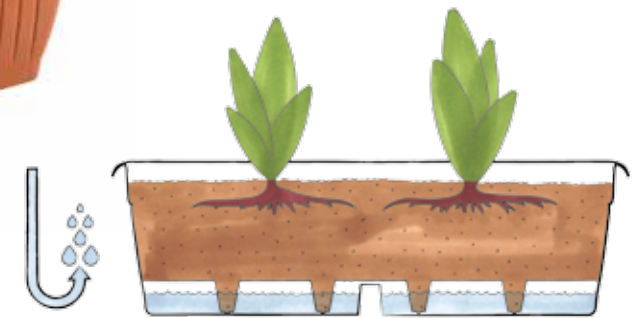
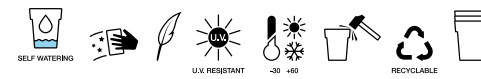

codice senza colore code without colour	Cm	dimensioni dimensions	Confezione minima Minimum package	pezzi pallet pcs pallet
01 016 040	40	a40 b27 c17,3	104 80x60x115h	0,55 224 80x120x115h
01 016 050	50	a50 b20 c17,3	78 80x60x115h	0,55 168 80x120x115h
01 016 060	60	a60 b20 c17,3	78 80x60x115h	0,55 168 80x120x115h

supporto Coste

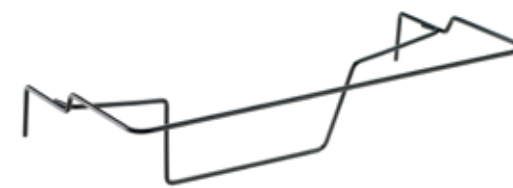

codice senza colore code without colour	Cm	Confezione minima Minimum package
10 901 040	40	10 40x28x30h
10 901 050	50	10 50x28x30h
10 901 060	60	10 60x28x30h

supporto Mare



codice senza colore code without colour	Cm	Confezione minima Minimum package
10 900 040	40	10 46x30x24h
10 900 050	50	10 56x30x24h
10 900 060	60	10 66x30x24h
10 900 080	80	10 86x30x24h



Superficie opaca
Matt finished
Surface opaque
Matt-Oberfläche

Superficie opaca
Matt finished
Surface opaque
Matt-Oberfläche

Sottocassetta colour

Sottocassetta classic

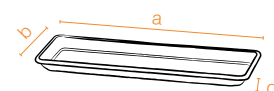

codice senza colore code without colour	Cm	dimensioni dimensions	litri liters	Confezione minima Minimum package	m ³	pezzi pallet pcs pallet	m ³
01 012 040	40	a38 b19 c3,2	2	10 38x19x15h	0,01	240	0,12
01 012 050	50	a48 b19 c3,2	3	10 48x19x15h	0,01	160	0,12
01 012 060	60	a58 b19 c3,2	5	10 58x19x15h	0,01	160	0,12
01 012 080	80	a78 b19 c3,2	8	10 78x19x15h	0,02	1080	1,10
01 012 100	100	a98 b19 c3,2	10	10 98x19x15h	0,02	720	1,10

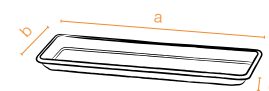

codice senza colore code without colour	Cm	dimensioni dimensions	litri liters	Confezione minima Minimum package	m ³	pezzi pallet pcs pallet	m ³
01 012 040	40	a38 b19 c3,2	2	10 38x19x15h	0,01	240	0,12
01 012 050	50	a48 b19 c3,2	3	10 48x19x15h	0,01	160	0,12
01 012 060	60	a58 b19 c3,2	5	10 58x19x15h	0,01	160	0,12
01 012 080	80	a78 b19 c3,2	8	10 78x19x15h	0,02	1080	1,10
01 012 100	100	a98 b19 c3,2	10	10 98x19x15h	0,02	720	1,10



disponibile anche:
also available:
aussi disponible:
verfügbar auch:



Espositore Hydral

Codice ESPOSITORE:
Code for empty Hydral display:
Code du présentoir vide pour les Hydral:
Kode für den leeren Ständer des Hydrals:
10919830000

L'espositore è adatto per contenere i nostri articoli HYDRAL nelle seguenti misure e quantità:

The Display is suitable to hold our HYDRAL in the following sizes and quantities:

Le présentoir est apte à contenir nos articles HYDRAL dans les tailles et quantités suivantes:

Der Präsentationsständer ist für unseren Artikel HYDRAL geeignet und kann folgende Größen und Mengen enthalten:

codice senza colore code without colour	descrizione	quantità totale consigliata	minimo vendita per colore
28 107 018	hydral 18	20	20
28 107 023	hydral 23	20	10
28 107 028	hydral 28	20	10
28 107 033	hydral 33	20	5
28 107 038	hydral 38	20	8



Display



disponibile anche: / also available:
aussi disponible: / verfügbar auch:



Espositore cilindri e sottovasi

Codice ESPOSITORE:
Code for empty Cylinder and saucers display:
Code du présentoir vide pour les Cylindres:
Kode für den leeren Ständer der Zylinder und
Untersetzer:
10915830000

L'espositore è adatto per contenere i nostri articoli CILINDRO INIEZIONE e SOTTOVASO INIEZIONE nelle seguenti misure e quantità:

The Display is suitable to hold our ITEMS CYLINDER INJECTION AND SAUCER INJECTION in the following sizes and quantities:

Le présentoir est apte à contenir nos articles CYLINDRE INJECTÉ et SOUCOUPES dans les tailles et quantités suivantes:

Der Präsentationsständer ist für unseren Artikel INJEKTION ZYLINDER TOPF und UNTERSETZER RUND in den folgenden Größen und Mengen als Behälter geeignet:

codice senza colore code without colour	descrizione	quantità totale consigliata	minimo vendita per colore
01 001 020	Cilindro cm 20	10	20
01 001 025	Cilindro cm 25	10	10
01 001 030	Cilindro cm 30	10	10
01 001 035	Cilindro cm 35	10	10
01 001 040	Cilindro cm 40	5	10

codice senza colore code without colour	descrizione	quantità totale consigliata	minimo vendita per colore
01 011 018	Sottovaso cm 18	10	100
01 011 022	Sottovaso cm 22	10	50
01 011 026	Sottovaso cm 26	10	50
01 011 030	Sottovaso cm 30	10	25
01 011 035	Sottovaso cm 35	5	25



disponibile anche:
also available:
aussi disponible:
verfügbar auch:



Espositore cassette e sottocassette

Codice ESPOSITORE:

Code for empty Balcony boxes and saucers display:

Code du présentoir vide pour les cylindres et les soucoupes:

Kode für den leeren Ständer von Zylinder und Untersetzer:

10918830000

L'espositore è adatto per contenere le CASSETTE e LE SOTTOCASSETTE INIEZIONE nelle seguenti misure e quantità:

The Display is suitable to contain our items BALCONY BOXES INJECTION AND SAUCER INJECTION in the following sizes and quantities:

Le présentoir est apte à contenir nos articles CYLINDRE INJECTÉ et SOUCOUPES dans les tailles et quantités suivantes:

Der Präsentationsständer ist für unseren Artikel INJEKTION ZYLINDER TOPF und UNTERSETZER RUND in folgenden Größen und Mengen als Behälter geeignet:

codice senza colore code without colour	descrizione	quantità totale consigliata	minimo vendita per colore
01 004 040	Cassetta cm 40	15	10
01 004 050	Cassetta cm 50	15	10
01 004 060	Cassetta cm 60	15	10
01 004 080	Cassetta cm 80	15	10

codice senza colore code without colour	descrizione	quantità totale consigliata	minimo vendita per colore
01 012 040	Sottocassetta cm 40	15	10
01 012 050	Sottocassetta cm 50	15	10
01012060	Sottocassetta cm 60	15	10
01 012 080	Sottocassetta cm 80	15	10

Espositore cilindri

Codice ESPOSITORE CILINDRI:

Code for Cylinder display:

Code du présentoir pour les Cylindres:

Kode für Zylinderständer:

10911830000

L'espositore è adatto per contenere il nostro articolo CILINDRO INIEZIONE nelle seguenti misure e quantità:

The Display is suitable to hold our article CYLINDER INJECTION in the following sizes and quantities:

Le présentoir est apte à contenir notre article CYLINDRE INJECTÉ dans les tailles et quantités suivantes:

Der Präsentationsständer ist für unseren Artikel INJEKTION ZYLINDER TOPF in den folgenden Größen und Mengen als Behälter geeignet:



codice senza colore code without colour	descrizione	quantità totale consigliata	minimo vendita per colore
01 001 020	Cilindro cm 20	40	20
01 001 025	Cilindro cm 25	40	10
01 001 030	Cilindro cm 30	40	10
01 001 035	Cilindro cm 35	40	10
01 001 040	Cilindro cm 40	40	10

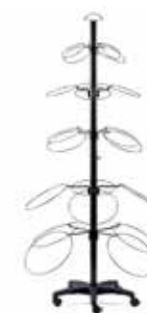

Espositore sottovasi

Codice ESPOSITORE SOTTOVASI:

Code for Saucer Display:

Code du présentoir pour les Soucoupes:

Kode für Untersetzerständer:

10909830000

L'espositore è adatto per contenere il nostro articolo SOTTOVASO ROTONDO INIEZIONE nelle seguenti misure e quantità:

The Display is suitable to hold our article ROUND SAUCER INJECTION in the following sizes and quantities:

Le présentoir est apte à contenir notre article SOUCOUE RONDE INJECTÉE dans les tailles et quantités suivantes:

Der Präsentationsständer ist für unseren Artikel INJEKTION UNTERSETZER RUND in den folgenden Größen und Mengen als Behälter geeignet:



codice senza colore code without colour	descrizione	quantità totale consigliata	minimo vendita per colore
01 011 012	Sottovaso cm 12	100	100
01 011 014	Sottovaso cm 14	100	100
01 011 016	Sottovaso cm 16	100	100
01 011 018	Sottovaso cm 18	50	100
01 011 020	Sottovaso cm 20	50	50
01 011 022	Sottovaso cm 22	50	50
01 011 024	Sottovaso cm 24	50	50
01 011 026	Sottovaso cm 26	50	50
01 011 028	Sottovaso cm 28	50	50
01 011 030	Sottovaso cm 30	50	25
01 011 035	Sottovaso cm 35	50	25
01 011 040	Sottovaso cm 40	50	25
01 011 045	Sottovaso cm 45	50	25
01 011 052	Sottovaso cm 52	50	25



Teraplast Marketing support

Teraplast può aiutarti anche per quanto riguarda il punto vendita, offrendo una grande varietà di display e scaffalature espositive. Sono soluzioni ideali perché sono maneggevoli e attrattive per il consumatore finale.

Teraplast Marketing support

Teraplast may help you also concerning shops, offering a wide range of display solutions and shelves. They are ideal solutions, because they are manageable and eye catching for consumers.



DISPLAY



Teraplast Marketing support

Teraplast kann Ihnen auch im Shop mit einer Vielzahl von Displays und Ausstellungsregale behilflich sein. Es handelt sich um ideale Lösungen, die einfach zu handhaben sind und für den Endverbraucher anziehend wirken.

Teraplast Marketing support

Au niveau de point de vente Teraplast peut vous aider avec une grande variété de display et présentoirs. Il s'agit de solutions idéales car elles sont faciles à utiliser et attrayant pour le consommateur finale



Un prodotto presentato con **gusto e chiarezza** è un prodotto che comunica **qualità**.

La presentazione delle famiglie di prodotti insieme, coordinati nei colori e nello stile, comunica un marchio forte e affidabile.

I nostri display pallet sono ideali per proporre nuove e interessanti combinazioni di colori.

A **tasteful and clear** product is a product which conveys **quality**.

The presentation of coordinate products in terms of colours improves its visual impact and increases pulse purchases.

Our display pallet are flexible solution suitable for several promotions.



DISPLAY



Le produit qui est présenté avec **bon goût et clarté** est un produit qui communique la **qualité**.

La présentation des produits coordonnés en rapport aux couleurs renforce l'impact visuel du produit et il augmente les achats d'impulsion.

Nos palettes display offrent des solutions flexibles et adaptées à nombreux promotions.

Ein Produkt das **gut** und in einer **geordneten Art** präsentiert wird betont auch die **Qualität**.

Die Ausstellung der Produkte mit gut aufeinander abgestimmte Farben hat optisch einen positiven Einfluss und erhöht die Impulskaufe.

Unsere Displaypaletten sind flexible Lösungen die sich gut für Promotionen eignen.



display kit balcone **Mare** 1 pz

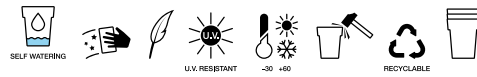

022
bianco/white
blanc/weiß

403
corda/cord
corde/seil

406
bruno/brown
brun/braun

408
cacao/cocoa
cacao/kakao



018
ciclaminò/cyclamen
cyclamen/zyklamfarbe

019
lilla/lilac
lilas/lila

404
cedro/cedar
cèdre/zeder



001
terracotta/terracotta colour
couleur terre/farbe terrakotta

005
antracite/anthracite
anthracite/anthrazitgrau

codice senza colore code without colour	Cm	dimensioni dimensions	pezzi pallet pcs pallet	m ³
01 015 040 022 403 406 408 018 019 404 001 005	40	a40 b17 c14,5	48	80x120x115h 1,10
01 015 050 022 403 406 408 018 019 404 001 005	50	a50 b17 c14,5	42	80x120x115h 1,10
01 015 060 022 403 406 408 018 019 404 001 005	60	a60 b17 c14,5	35	80x120x115h 1,10
01 015 080 403 406 408 001 005	80	a80 b17 c14,5	24	80x120x105h 1,10

display kit balcone **Mare** 2 pz

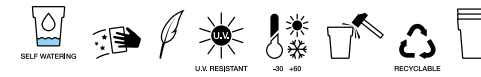

022
bianco/white
blanc/weiß

403
corda/cord
corde/seil

406
bruno/brown
brun/braun

408
cacao/cocoa
cacao/kakao



018
ciclaminò/cyclamen
cyclamen/zyklamfarbe

019
lilla/lilac
lilas/lila

404
cedro/cedar
cèdre/zeder



001
terracotta/terracotta colour
couleur terre/farbe terrakotta

005
antracite/anthracite
anthracite/anthrazitgrau

codice senza colore code without colour	Cm	dimensioni dimensions	pezzi pallet pcs pallet	m ³
01 019 040 022 403 406 408 018 019 404 001 005	40	a40 b17 c14,5	40	80x120x115h 1,10
01 019 050 022 403 406 408 018 019 404 001 005	50	a50 b17 c14,5	35	80x120x115h 1,10
01 019 060 022 403 406 408 018 019 404 001 005	60	a60 b17 c14,5	25	80x120x115h 1,10
01 019 080 403 406 408 001 005	80	a80 b17 c14,5	18	80x120x115h 1,10



T-BASKET

T-BASKET



T-Basket



T-Basket Big



ideale per contenere
3 vasi da 14 cm
Ideal for containing
3 pots of 14 cms
Idéal pour contenir 3
vases à 14 cm
Ideal um 3 Vasen à
14cm zu fassen

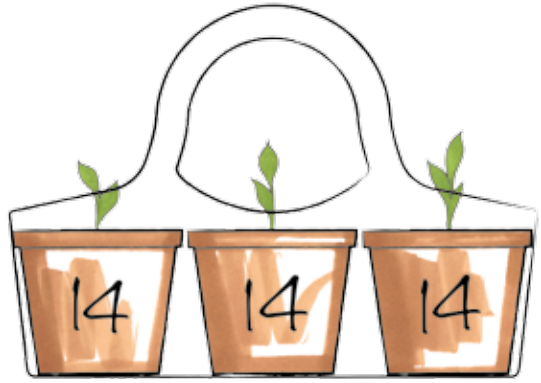

Linea Flortec
pagina 142



022
bianco/white
blanc/weiß



010
rosso/red
rouge/rot



402
lilyum/lilyum
lilyum/lilyum



404
cedro/cedar
cèdre/zeder



406
bruno/brown
brun/braun



Superficie opaca
Matt finished
Surface opaque
Matt-Oberfläche



T-Basket

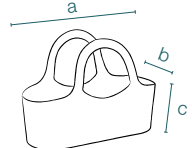

codice senza colore code without colour	Cm	dimensioni dimensions	pezzi pallet pcs pallet	m ³
BOX 1 COLOUR 26 101 000		a43 b18 c31	10	44x18x55h 0,043
BIG BOX 26 101 000		a48 b18 c31	78	57x50x103h 0,293



022
bianco/white
blanc/weiß



010
rosso/red
rouge/rot



419
giallo/yellow
jaune/gelb



402
lilyum/lilyum
lilyum/lilyum



404
cedro/cedar
cèdre/zeder



415
terra di Siena/terra di siena
terra di siena/terra di siena

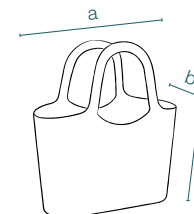

codice senza colore code without colour	Cm	dimensioni dimensions	pezzi pallet pcs pallet	m ³
BOX 1 COLOUR	26 102 000	a48 b18 c51	6	44x18x55h 0,043
BIG BOX	26 102 000	a48 b18 c51	63	57x50x103h 0,293



Superficie opaca
Matt finished
Surface opaque
Matt-Oberfläche



T-Basket big



LINEA FLORTEC

linea
FLORTEC



Norma



Container



Crisa



Basso

vaso Norma



001
terracotta/terracotta colour
couleur terre/farbe terrakotta



003
nero/black
noir/schwarz

A richiesta sono disponibili altri colori
Further colours are available on demand
D'autres couleurs sont disponibles sur demande
Weiteren Farben sind auf Anforderung vorrätig



010
rosso/red
rouge/rot



013
giallo/yellow
jaune/gelb



015
azzurro/light blue
azur/hellblau



016
arancio/orange
orange/orange



018
ciclamo/cyclamen
cyclamen/zyklamfarbe



019
lilla/lilac
lilas/lila



404
cedro/cedar
cèdre/zeder

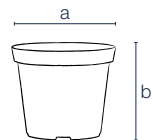

codice senza colore code without colour	Cm	colori colour	colori a richiesta colours on request	dimensioni dimensions	litri liters	pz/conf pcs/pack	Pcs Pit
03 300 008	8	001 003	010 013 015 016 018 019 404	a8 b6,8	0,2	2275	36400
03 300 010	10	001 003	010 013 015 016 018 019 404	a10 b7,7	0,38	1610	25760
03 300 011	11	001 003	010 013 015 016 018 019 404	a11 b8,8	0,53	1188	19008
03 300 012	12	001 003	010 013 015 016 018 019 404	a12 b10	0,72	915	14640
03 300 013	13	001 003	010 013 015 016 018 019 404	a13 b11	0,94	840	13440
03 300 014	14	001 003	010 013 015 016 018 019 404	a14 b12	1,25	671	10736
03 300 015	15	001 003	010 013 015 016 018 019 404	a15 b13	1,51	495	7920
03 300 016	16	001 003	010 013 015 016 018 019 404	a16 b12,2	1,79	360	5760
03 300 018	18	001 003	010 013 015 016 018 019 404	a18 b13,6	2,61	300	4800

Flortec Special Packaging



LINEA FLORTEC



We can provide to our customers a wide range of **special packaging**.

Nous pouvons vous fournir une large gamme d'**emballages spéciaux**.

Lieferung in **Sonderverpackungen** möglich.

Siamo in grado di fornirvi un'ampia gamma di **imballi speciali**.

vaso **Container**



001
 terracotta/terracotta colour
 couleur terre/farbe terrakotta

003
 nero/black
 noir/schwarz

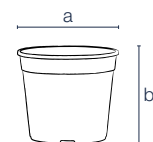

codice senza colore code without colour	Cm	colori colour	colori a richiesta colours on request	dimensioni dimensions	litri liters	pz/conf pcs/pack	Pcs Pit
03 301 015	15	001 003		a15 b13	1,63	423	6768
03 301 019	19	001 003	010 013 015 016 018 019 404	a19 b17,4	3,43	186	2976

vaso **Basso**



001
 terracotta/terracotta colour
 couleur terre/farbe terrakotta

003
 nero/black
 noir/schwarz

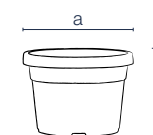

codice senza colore code without colour	Cm	colori colour	dimensioni dimensions	litri liters	pz/conf pcs/pack	Pcs Pit
03 303 017	17	001 003	a17 b12	1,74	192	3072

vaso **Crisa**



001
 terracotta/terracotta colour
 couleur terre/farbe terrakotta

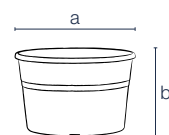

codice senza colore code without colour	Cm	colori colour	dimensioni dimensions	litri liters	pz/conf pcs/pack	Pcs Pit
03 304 022	22	001	a22 b15	3,31	140	2240

Gabbia verde



002
 verde/green
 vert/grün

codice senza colore code without colour	Cm	colori colour	dimensioni dimensions	pz/conf pcs/pack	Pcs Pit
03 302 014	14	002	a14 b22	240	4800



linea ESSENTIAL

-  Schio Cubo Alto
-  Schio Cubo Basso
-  Schio Cubo
-  Avila
-  Ribeira
-  Jardinera Veneto
-  Tondo Veneto
-  Schio Cassa Alta
-  Schio Cono
-  Schio Ciotola

-  Urban
-  Divio
-  Corner
-  Schio Cassa
-  Zamora
-  Leon
-  Standard One
-  Quadro Veneto
-  Cassa Veneto
-  Pasubio Alto
-  Pasubio Quadro
-  Pasubio Cassa
-  Valentino
-  Bassano

news
2017



043
bianco/white
blanc/weiß



201
cappuccino/cappuccino
cappuccino/cappuccino



235
beton/beton
beton/beton



032
antracite/anthracite
anthracite/anthrazitgrau



039
bronz/bronz
bronz/bronz

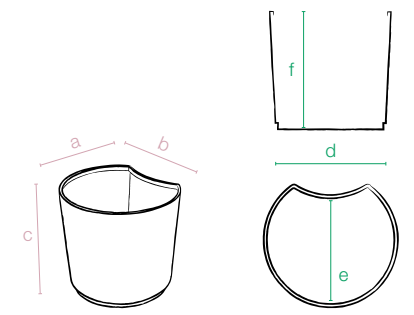

codice senza colore code without colour	Cm	dimensioni esterne external dimensions			dimensioni interne internal dimensions			litri liters	Confezione minima Minimum package	pezzo m ³	pezzi pallet pcs pallet	pezzi pallet m ³
29 472 040	40	a41	b46,6	c39,8	d44,5	e35	f38,5	52	2 41x46,6x63h	0,11	44	80x120x230h 2,2
29 472 047	47	a46,3	b51,5	c47,2	d49	e41	f46	77	2 46,3x51,5x67h	0,16	40	100x115x224h 2,5
29 472 054	54	a51,4	b56,1	c54	d54	e45	f53	106	2 51,4x56,1x72,5h	0,2	36	100x115x218h 2,5

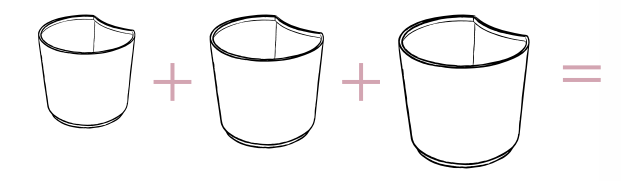

codice senza colore code without colour	Cm	dimensioni dimensions			Confezione minima Minimum package	pezzi pallet m ³	pezzi pallet pcs pallet
14 999 002	40	a51,4	b56,1	c54	1 51,4x56,1x54h	0,15	16 100x120x204h



Superficie opaca
Matt finished
Surface opaque
Matt-Oberfläche



Urban

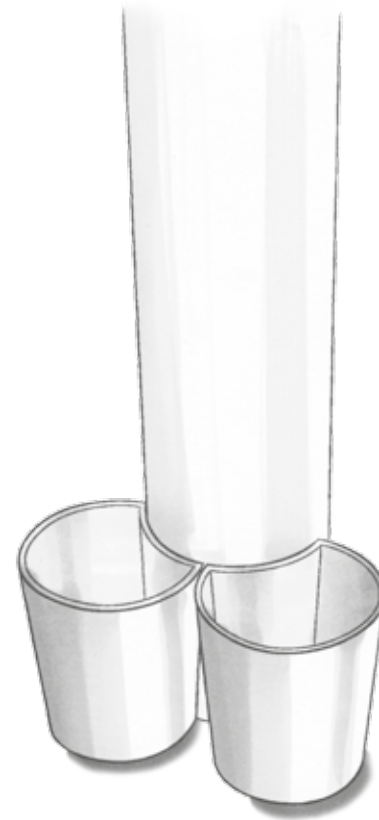

Urban family
componibile
modular
modulable
zusammensetzbar



Grazie ai diversi formati disponibili, Urban permette di creare tantissime composizioni e di modificarle con grande facilità.

With the different sizes of Urban you can create many compositions and modify them easily.

Les différentes mesures de l' Urban vous permettent de créer de nombreuses compositions et de les modifier facilement.

Mit den verschiedenen Größen des Urbans sind viele Zusammensetzungen möglich, die sich auch leicht ändern lassen.

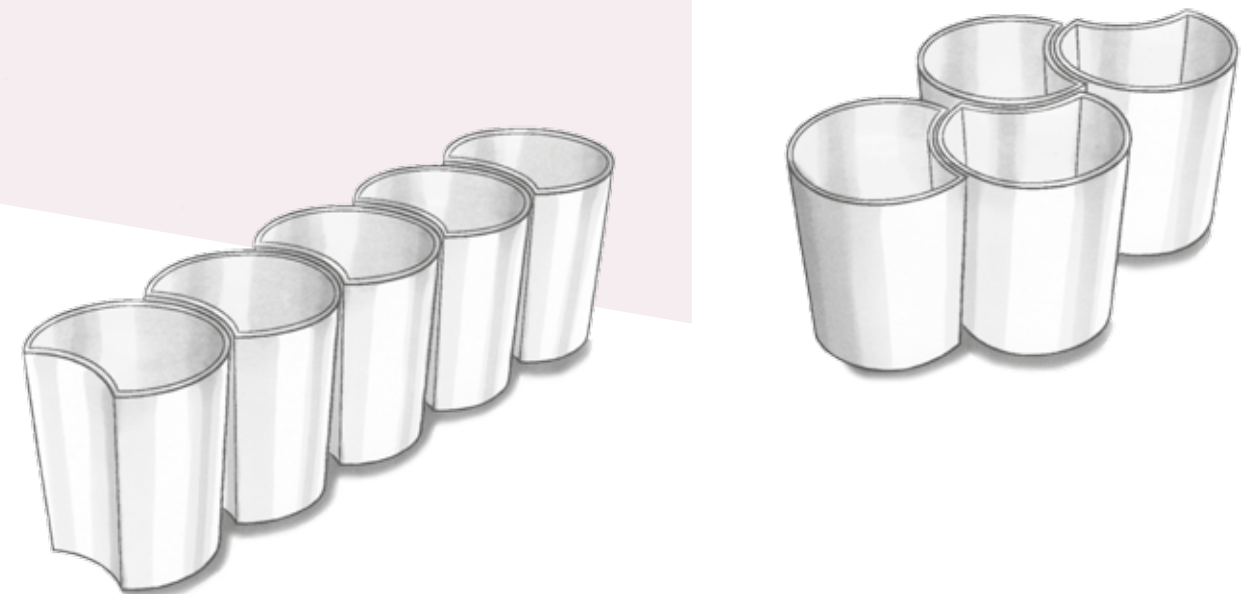



Divio indoor



043

bianco/white
blanc/weiß



201

cappuccino/cappuccino
cappuccino/cappuccino



210

grafite/graphite
graphite/graphit



232

kiwi/kiwi
kiwi/Kiwi

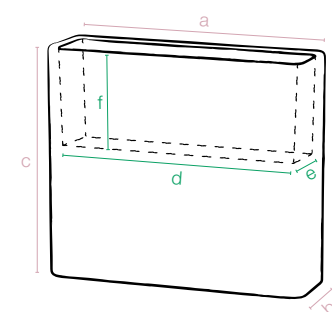

codice senza colore code without colour	Cm	dimensioni esterne external dimensions	dimensioni interne internal dimensions	litri liters	Confezione minima Minimum package	m ³	pezzi pallet pcs pallet	m ³
11 466 080	80	a:90 b:27 c:77	d:85 e:21 f:33	59	1 91x28x79h	0,2	8 80x120x201h	1,93

Corner indoor



043

bianco/white
blanc/weiß



201

cappuccino/cappuccino
cappuccino/cappuccino



210

grafite/graphite
graphite/graphit



232

kiwi/kiwi
kiwi/Kiwi

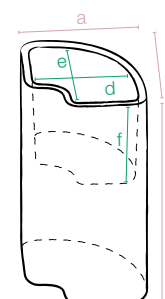

codice senza colore code without colour	Cm	dimensioni esterne external dimensions	dimensioni interne internal dimensions	litri liters	Confezione minima Minimum package	m ³	pezzi pallet pcs pallet	m ³
11 467 080	80	a:39 b:39 c:77	d:22 e:34 f:33	26	1 40x40x79h	0,1	15 80x120x213h	2,04



Superficie opaca
Matt finished
Surface opaque
Matt-Oberfläche



Divio e Corner

Divio + Corner
componibili
modular
modulable
zusammensetzbar

permettono diverse combinazioni
allow various combinations
ils permettent différentes combinaisons
Divio und Corner ermöglichen viele Zusammenstellungen

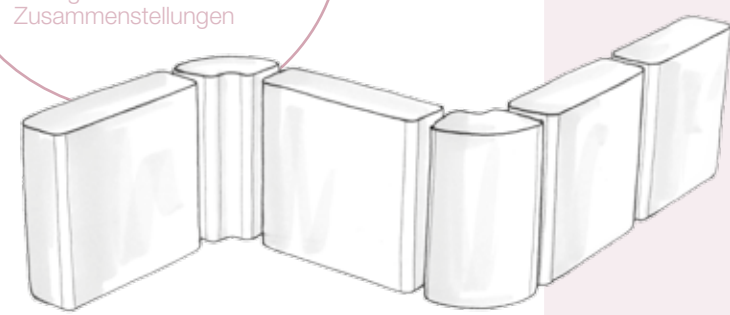

in base all'ambiente
depending on the environment
en fonction de l'environnement
nach dem Raum

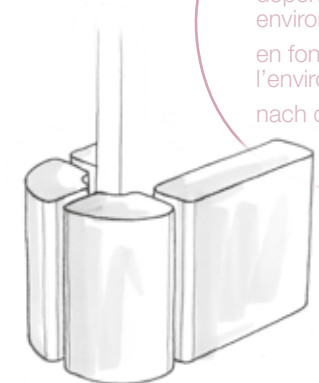

Divio e Corner si prestano molto bene per organizzare gli spazi

DIVIO and CORNER lend very well to organize spaces

Divio et Corner se prêtent très bien pour l'organisation des espaces

Divio und Corner sind ideal für die Teilung der Räume

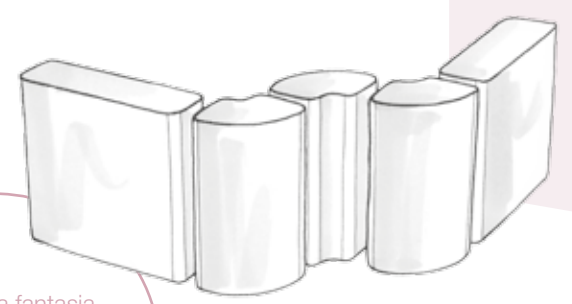

e alla vostra fantasia
and to your imagination
et à votre imagination
und Ihrer Fantasie

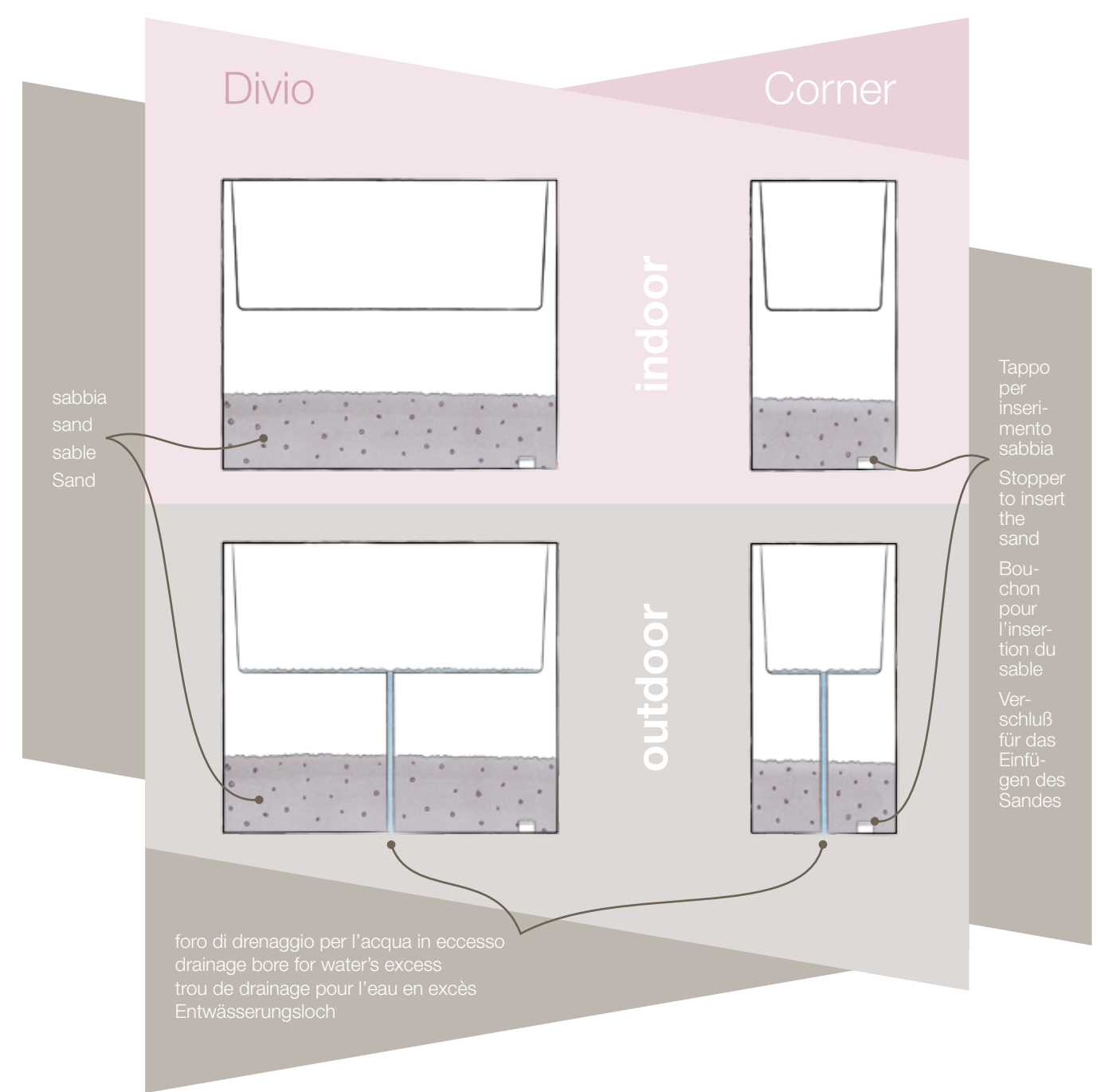
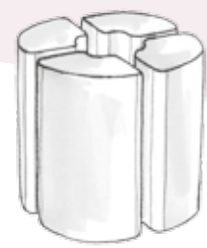

Divio outdoor

codice senza colore code without colour	Cm	dimensioni esterne external dimensions	dimensioni interne internal dimensions	litri liters	Confezione minima Minimum package	m ³	pezzi pallet pcs pallet	m ³			
15 466 080	043 201 210 232	80	a90 b27 c77	d85 e21 f33	59	1	91x28x79h	0,2	8	80x120x201h	1,93

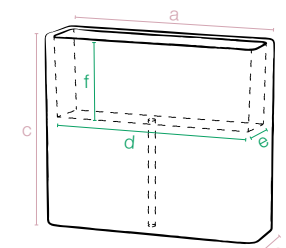

Corner outdoor

codice senza colore code without colour	Cm	dimensioni esterne external dimensions	dimensioni interne internal dimensions	litri liters	Confezione minima Minimum package	m ³	pezzi pallet pcs pallet	m ³			
15 467 080	043 201 210 232	80	a39 b39 c77	d22 e34 f33	26	1	40x40x79h	0,1	15	80x120x213h	2,04

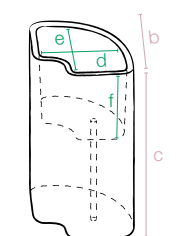

Schio cassa



Superficie opaca
Matt finished
Surface opaque
Matt-Oberfläche



Schio cubo alto



Superficie opaca
Matt finished
Surface opaque
Matt-Oberfläche



043

bianco/white
blanc/weiß



201

cappuccino/cappuccino
cappuccino/cappuccino



032

antracite/anthracite
anthracite/anthrazitgrau



050

rosso cardinale/cardinal red
rouge cardinal/scharlachrot



039

bronzo/bronze
bronze/bronze



043

bianco/white
blanc/weiß



201

cappuccino/cappuccino
cappuccino/cappuccino



032

antracite/anthracite
anthracite/anthrazitgrau



050

rosso cardinale/cardinal red
rouge cardinal/scharlachrot



039

bronzo/bronze
bronze/bronze

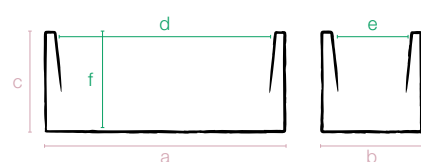

codice senza colore code without colour	Cm	dimensioni esterne external dimensions			dimensioni interne internal dimensions			litri liters	Confezione minima Minimum package	m ³	pezzi pallet pcs pallet	m ³		
11 427 060	60	a 60	b 25	c 25	d 54	e 20	f 25	26	2	60x25x50h	0,07	24	80x120x115h	1,10
11 427 080	80	a 80	b 30	c 30	d 73	e 24	f 30	51	2	80x30x30h	0,07	28	80x120x222h	2,13
11 427 100	100	a 100	b 40	c 40	d 90	e 30	f 40	108	1	100x40x40h	0,16	10	80x120x210h	2,52
11 427 120	120	a 115	b 50	c 50	d 103	e 38	f 50	195	1	115x50x50h	0,28	8	100x120x220h	2,53

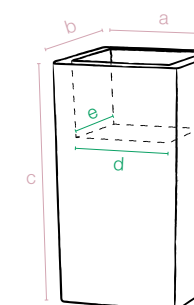

codice senza colore code without colour	Cm	dimensioni esterne external dimensions			dimensioni interne internal dimensions			litri liters	Confezione minima Minimum package	m ³	pezzi pallet pcs pallet	m ³	accessori accessories		
11 426 080	80	a 40	b 40	c 80	d 30	e 30	f 20	31	1	40x40x80h	0,07	15	80x120x215h	1,10	

Fix Ground
Fix Wall
pagina 198





Schio

cubo basso



Superficie opaca
Matt finished
Surface opaque
Matt-Oberfläche

Schio

cubo



Superficie opaca
Matt finished
Surface opaque
Matt-Oberfläche



043

bianco/white
blanc/weiß



201

cappuccino/cappuccino
cappuccino/cappuccino



032

antracite/anthracite
anthracite/anthrazitgrau



050

rosso cardinale/cardinal red
rouge cardinal/scharlachrot



039

bronzo/bronze
bronze/bronze



043

bianco/white
blanc/weiß



201

cappuccino/cappuccino
cappuccino/cappuccino



032

antracite/anthracite
anthracite/anthrazitgrau



050

rosso cardinale/cardinal red
rouge cardinal/scharlachrot



039

bronzo/bronze
bronze/bronze

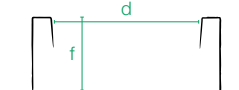
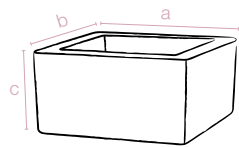

codice senza colore code without colour	Cm	dimensioni esterne external dimensions	dimensioni interne internal dimensions	litri liters	Confezione minima Minimum package	m ³	pezzi pallet pcs pallet	m ³
11 456 050	50	a50 b50 c20	d40 e40 f19	26	1 50x50x20h	0,05	14 80x120x115h	0,55

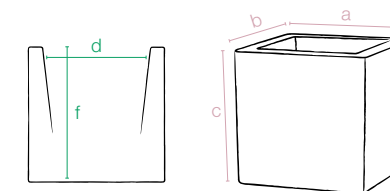

codice senza colore code without colour	Cm	dimensioni esterne external dimensions	dimensioni interne internal dimensions	litri liters	Confezione minima Minimum package	m ³	pezzi pallet pcs pallet	m ³
11 425 025	25	a25 b25 c25	d19,5 e19,5 f24	9	1 25x25x25h	0,01	48 80x120x115h	0,55
11 425 030	30	a30 b30 c30	d23,5 e23,5 f28	15	1 30x30x30h	0,02	24 80x120x115h	1,10
11 425 040	40	a40 b40 c40	d30 e30 f38	34	1 40x40x40h	0,06	12 80x120x92h	0,88
11 425 050	50	a50 b50 c50	d38 e38 f38	55	1 50x50x50h	0,12	8 100x120x112h	1,34
11 425 060	60	a58 b58 c58	d45 e45 f58	117	1 58x58x58h	0,19	6 80x120x200h	1,92



Schio family
componibile
modular
modulable
zusammensetzbar

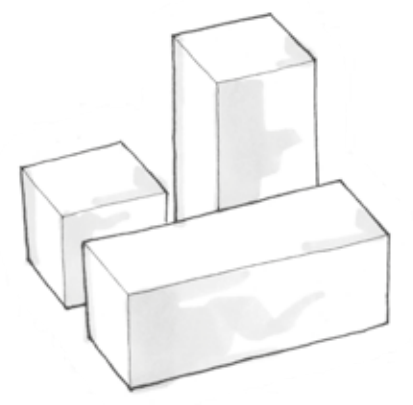
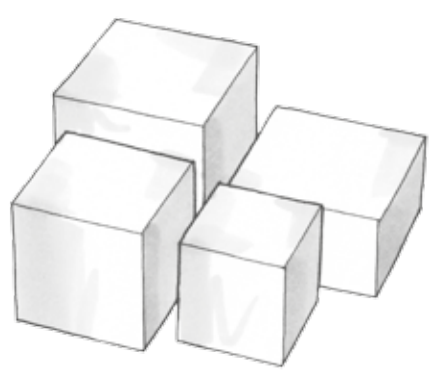

Schio cubo, Schio cubo alto e Schio cassa si prestano molto bene per organizzare gli spazi

Schio cubo, Schio cubo alto and Schio cassa lend very well to organize spaces

Schio Cubo, Cubo Alto et Cassa se prêtent très bien pour l'organisation des espaces

Schio Cubo, Schio Cubo Alto und Schio Cassa sind ideal für die Organization der Räume



“Semplicemente accostando 3 vasi ho dato un ordine al mio giardino”
“By simply approaching 3 pots I gave an order to my garden.”
“En approchant simplement 3 pots j'ai donné un ordre à mon jardin”
“Ich habe 3 Töpfe zusammengestellt und mein Garten sieht gepflegter aus”
Alessandra

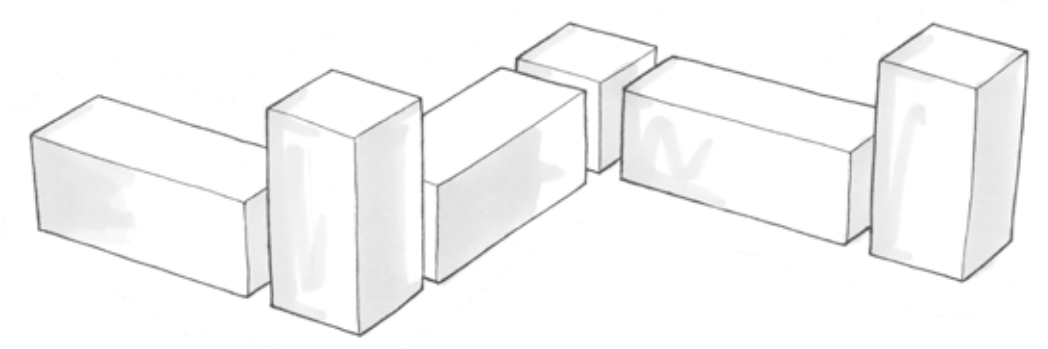
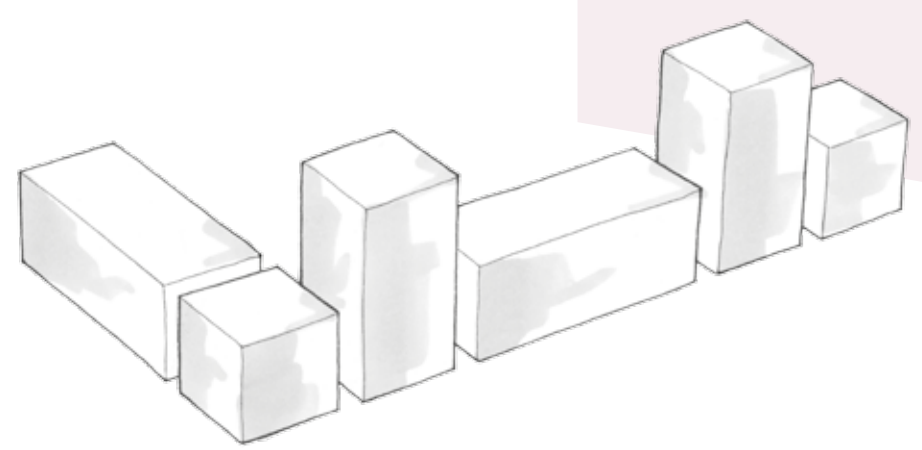
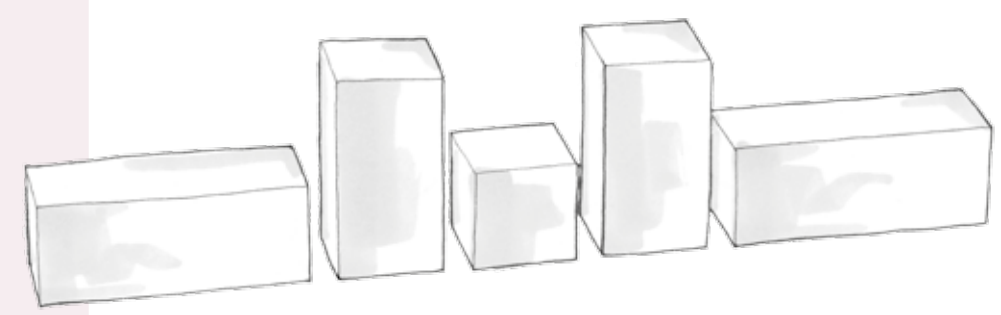



043
bianco/white
blanc/weiß



204
grigio seta/silk grey
grise soie/grauer Seide



201
cappuccino/cappuccino
cappuccino/cappuccino



032
antracite/anthracite
anthracite/anthrazitgrau



233
toffee/toffee
caramel/Toffee



202
lavanda/lavender
lavande/lavendel



068
fucsia/fuchsia
fuchsia/fuchsiensfarbig



232
kiwi/kiwi
kiwi/Kiwi



Superficie opaca
Matt finished
Surface opaque
Matt-Oberfläche

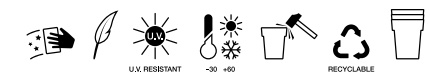

Avila

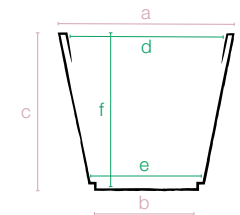

codice senza colore code without colour	Cm	dimensioni esterne external dimensions	dimensioni interne internal dimensions	litri liters	Confezione minima Minimum package	m ³	pezzi pallet pcs pallet	m ³
11 470 035	35	a33 b18 c30	d30 e17 f29	19	1 33x33x28h	0,03	66 80x120x115h	1,10
11 470 040	40	a38 b25 c32	d38 e25 f32	29	1 38x38x33h	0,04	54 80x120x115h	1,10
11 470 050	50	a49 b32 c42	d49 e32 f42	44	1 49x49x42h	0,10	64 100x115x220h	2,11



Sottovaso
pagina 202

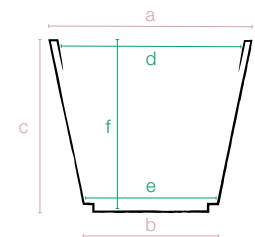
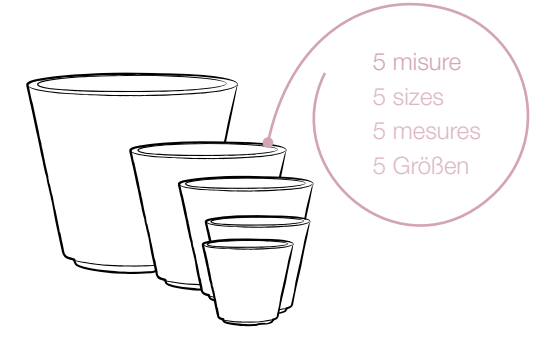

codice senza colore code without colour	Cm	dimensioni esterne external dimensions	dimensioni interne internal dimensions	litri liters	Confezione minima Minimum package	m ³	pezzi pallet pcs pallet	m ³
11 461 035	35	a33 b18,5 e29	d30 e18,5 f28	13	2	33x33x37h	0,04	63 80x120x115h 1,10
11 461 040	40	a38 b21,5 e35	d34,5 e21,5 f34	21	2	38x38x43h	0,06	114 80x120x230h 2,21
11 461 050	50	a49 b27,5 e43	d44,5 e27,5 f42	44	33	49x49x42h	0,10	64 100x120x230h 2,65
11 461 060	60	a57 b32 e49	d52 e32 f49	78	47	57x57x49h	0,15	28 80x120x220h 2,11
11 461 080	80	a77 b43 e65	d70 e43 f65	191	54	77x77x65h	0,38	10 80x80x220h 1,40

Superficie opaca
Matt finished
Surface opaque
Matt-Oberfläche

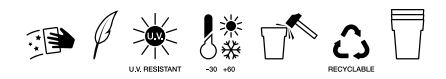

Ribeira



043
bianco/white
blanc/weiß



204
grigio seta/silk grey
grise soie/grauer Seide



201
cappuccino/cappuccino
cappuccino/cappuccino



068
fucsia/fuchsia
fuchsia/fuchsienfarbig



232
kiwi/kiwi
kiwi/Kiwi



202
lavanda/lavender
lavande/lavendel



032
antracite/anthracite
anthracite/anthrazitgrau



Sottovaso
pagina 202

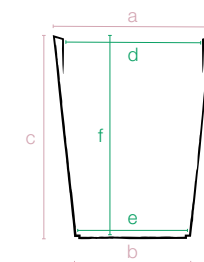

codice senza colore code without colour	Cm	dimensioni esterne external dimensions			dimensioni interne internal dimensions			litri liters		Confezione minima Minimum package	m ³	pezzi pallet pcs pallet	m ³
11 465 043	43	a33	b24	c42	d29	e24	f42	24	27	1 33x24x42h	0,03	96	80x120x225h 2,16
11 465 050	50	a39	b28,5	c50	d35	e28	f49	45	30	1 39x28,5x50h	0,30	60	80x120x215h 2,06
11 465 065	65	a49	b36	c66	d44	e35	f61	94	40	1 49x36x66h	0,10	21	80x120x210h 2,02

Superficie opaca
Matt finished
Surface opaque
Matt-Oberfläche



Zamora



043
bianco/white
blanc/weiß



201
cappuccino/cappuccino
cappuccino/cappuccino



032
antracite/anthracite
anthracite/anthrazitgrau

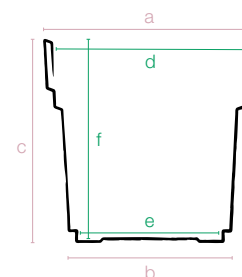

codice senza colore code without colour	Cm	dimensioni esterne external dimensions	dimensioni interne internal dimensions	litri liters	Confezione minima Minimum package	m ³	pezzi pallet pcs pallet	m ³
11 471 035	35	a33 b33 c33	d29 e29 f33	9	1 33x33x33h	0,03	63 80x120x115h	1,10
11 471 040	40	a38 b38 c38	d35 e35 f38	15	1 38x38x38h	0,05	48 80x120x115h	1,10



Superficie opaca
Matt finished
Surface opaque
Matt-Oberfläche



Leon



adatto anche per uso esterno
also suitable for outdoor use
également adapté pour une utilisation en extérieur
Outdoor geeignet



043
bianco/white
blanc/weiß



204
grigio seta/silk grey
grise soie/grauer Seide



201
cappuccino/cappuccino
cappuccino/cappuccino



030
anticato/light brown
marron clair/hellbraun



039
bronzo/bronze
bronze/bronze



050
rosso cardinale/cardinal red
rouge cardinal/scharlachrot



232
kiwi/kiwi
kiwi/Kiwi



202
lavanda/lavender
lavande/lavendel



032
antracite/anthracite
anthracite/anthrazitgrau



Sottovaso
pagina 202

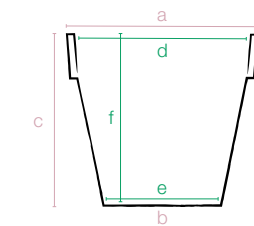

codice senza colore code without colour	Cm	dimensioni esterne external dimensions			dimensioni interne internal dimensions			litri liters	Confezione minima Minimum package	m ³	pezzi pallet pcs pallet	m ³
11 437 030	30	a30	b18,5	c27	d26,5	e18,5	f27	11	22	4 30x30x48h	0,04	88 80x120x115h 1,10
11 437 040	40	a40	b25	c35	d36	e25	f35	26	30	2 40x40x46h	0,07	48 80x120x112h 1,08
11 437 050	50	a50	b31	c43	d44	e31	f43	48	37	2 50x50x58h	0,14	64 100x120x226h 2,71
11 437 060	60	a60	b37	c54	d53	e37	f53	85	47	2 60x60x70h	0,25	22 80x120x215h 2,06
11 437 070	70	a70	b43	c63	d61	e43	f62	133	50	1 70x70x63h	0,30	9 80x80x215h 1,38
11 437 080	80	a80	b49	c72	d70	e49	f71	199	54	1 80x80x72h	0,46	8 80x80x220h 1,41
11 437 100	100	a100	b61	c90	d88	e61	f90	396	66	1 100x100x90h	0,90	6 100x120x225h 2,70
11 437 120	120	a120	b74	c108	d105	e74	f108	686	-	1 120x120x108h	1,29	4 120x120x215h 3,10
11 437 140	140	a140	b86	c126	d123	e86	f126	1079	-	1 140x140x207h	2,46	3 140x140x207h 4,05



Superficie opaca
Matt finished
Surface opaque
Matt-Oberfläche

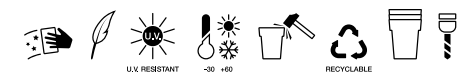

Standard one

quadro Veneto



Superficie opaca
Matt finished
Surface opaque
Matt-Oberfläche



cassa Veneto



Superficie opaca
Matt finished
Surface opaque
Matt-Oberfläche



043

bianco/white
blanc/weiß



201

cappuccino/cappuccino
cappuccino/cappuccino



039

bronzo/bronze
bronze/bronze



032

antracite/anthracite
anthracite/anthrazitgrau



043

bianco/white
blanc/weiß



201

cappuccino/cappuccino
cappuccino/cappuccino



039

bronzo/bronze
bronze/bronze



032

antracite/anthracite
anthracite/anthrazitgrau

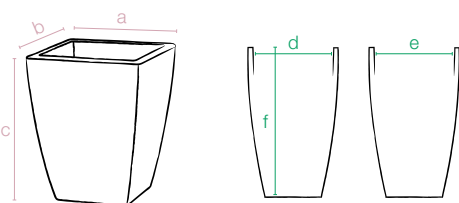

Sottovaso
pagina 203

codice senza colore code without colour	Cm	dimensioni esterne external dimensions			dimensioni interne internal dimensions			litri liters	Confezione minima Minimum package	m ³	pezzi pallet pcs pallet	m ³
11 407 035	35	a29	b29	c36	d25	e25	f36	17	30	2 29x29x57h	0,04	32 80x120x115h 1,10
11 407 040	40	a33	b33	c41	d28,5	e28,5	f41	25	30	2 33x33x66h	0,07	48 80x120x230h 2,21
11 407 050	50	a40	b40	c50	d34	e34	f50	44	30	2 40x40x78h	0,12	42 80x120x228h 2,19
11 407 060	60	a49	b49	c61	d42	e42	f61	83	36	2 49x49x61h	0,14	20 100x120x230h 2,65
11 407 065	65	a40	b40	c65	d34	e34	f65	56	30	2 40x40x107h	0,17	30 80x120x238h 2,28

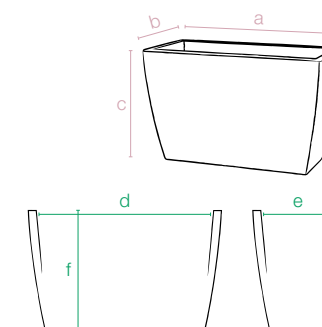

codice senza colore code without colour	Cm	dimensioni esterne external dimensions			dimensioni interne internal dimensions			litri liters	Confezione minima Minimum package	m ³	pezzi pallet pcs pallet	m ³
11 438 080	80	a80	b40	c50	d74	e35	f50	169	2 80x40x80h	0,25	18 80x120x228h 2,19	



jardinera Veneto



Superficie opaca
Matt finished
Surface opaque
Matt-Oberfläche



tondo Veneto



Superficie opaca
Matt finished
Surface opaque
Matt-Oberfläche



043

bianco/white
blanc/weiß



201

cappuccino/cappuccino
cappuccino/cappuccino



032

antracite/anthracite
anthracite/anthrazitgrau



039

bronzo/bronze
bronze/bronze

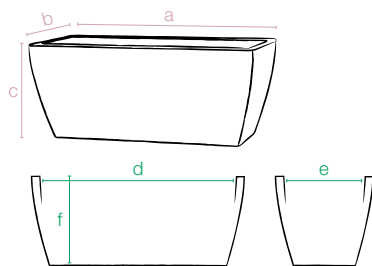

codice senza colore code without colour	Cm	dimensioni esterne external dimensions			dimensioni interne internal dimensions			litri liters	Confezione minima Minimum package	m ³	pezzi pallet pcs pallet	m ³
11 460 058	58	a58	b29	c25	d54	e25	f25	43	2 58x29x41h	0,06	52 80x120x230h	2,21
11 460 066	66	a66	b33	c28	d62	e29	f28	68	2 66x33x46h	0,10	33 80x120x230h	2,21
11 460 080	80	a79	b39	c33	d73	e33	f33	107	2 79x39x54h	0,16	27 80x120x230h	2,21



043

bianco/white
blanc/weiß



201

cappuccino/cappuccino
cappuccino/cappuccino



032

antracite/anthracite
anthracite/anthrazitgrau



039

bronzo/bronze
bronze/bronze

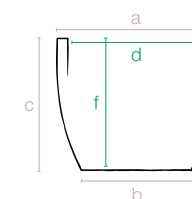

codice senza colore code without colour	Cm	dimensioni esterne external dimensions			dimensioni interne internal dimensions			litri liters	Confezione minima Minimum package	m ³	pezzi pallet pcs pallet	m ³
11 448 032	32	a32	b21	c27	d26	f25	11	2 32x32x48h	0,04	64 80x120x232h	2,23	
11 448 042	42	a42	b28	c35	d35	f33	26	2 42x42x63h	0,11	36 80x120x222h	2,13	
11 448 052	52	a52	b36	c43	d43	f40	49	2 52x52x80h	0,21	15 80x120x227h	2,72	
11 448 062	62	a62	b36	c50	d50	f44	64	2 62x62x88h	0,33	10 80x120x207h	1,99	



Schio cassa alta



Superficie opaca
Matt finished
Surface opaque
Matt-Oberfläche



Schio cono



Superficie opaca
Matt finished
Surface opaque
Matt-Oberfläche



043

bianco/white
blanc/weiß



201

cappuccino/cappuccino
cappuccino/cappuccino



032

antracite/anthracite
anthracite/anthrazitgrau



050

rosso cardinale/cardinal red
rouge cardinal/scharlachrot



043

bianco/white
blanc/weiß



201

cappuccino/cappuccino
cappuccino/cappuccino



032

antracite/anthracite
anthracite/anthrazitgrau



050

rosso cardinale/cardinal red
rouge cardinal/scharlachrot



039

bronzo/bronze
bronze/bronze

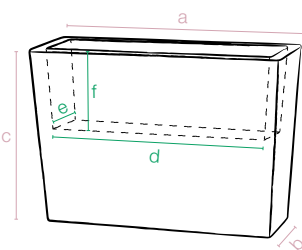

codice senza colore code without colour	Cm	dimensioni esterne external dimensions	dimensioni interne internal dimensions	litri liters	Confezione minima Minimum package	m ³	pezzi pallet pcs pallet	m ³
11 428 050	50	a50 b35 c69	d40 e26 f30	31	1 50x40x70h	0,14	12 80x120x222h	2,13
11 428 100	100	a100 b35 c69	d90 e26 f30	70	1 100x40x70h	0,28	6 80x120x222h	2,13

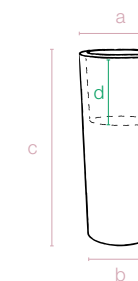

codice senza colore code without colour	Cm	dimensioni dimensions	litri liters	Confezione minima Minimum package	m ³	pezzi pallet pcs pallet	m ³	accessori accessoires
11 424 070	70	a30 b23 c68 d20	8	1 30x30x68h	0,06	24 80x120x225h	2,16	
11 424 090	90	a40 b29,5 c90 d26	26	1 40x40x90h	0,14	12 80x120x195h	1,87	
11 424 110	110	a45 b34,5 c110 d28	35	1 45x45x110h	0,22	12 80x120x236h	2,27	
11 424 145	145	a55 b44,5 c145 d31	46	1 55x55x145h	0,43	4 100x120x160h	1,92	

Fix Ground
Fix Wall
pagina 226



Pasubio quadro



Superficie opaca
Matt finished
Surface opaque
Matt-Oberfläche



Pasubio cassa



Superficie opaca
Matt finished
Surface opaque
Matt-Oberfläche



201

cappuccino/cappuccino
cappuccino/cappuccino



032

antracite/anthracite
anthracite/anthrazitgrau



201

cappuccino/cappuccino
cappuccino/cappuccino



032

antracite/anthracite
anthracite/anthrazitgrau

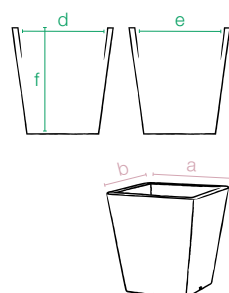

codice senza colore code without colour	Cm	dimensioni esterne external dimensions	dimensioni interne internal dimensions	litri liters	Confezione minima Minimum package	m ³	pezzi pallet pcs pallet	m ³
11 463 040	40	a40 b40 c42	d34 e34 f42	40	2 40x40x71h	0,11	24 80x120x210h	2,02

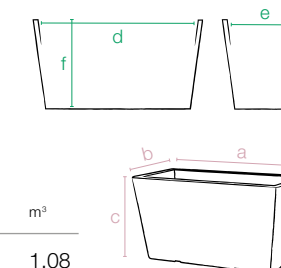

codice senza colore code without colour	Cm	dimensioni esterne external dimensions	dimensioni interne internal dimensions	litri liters	Confezione minima Minimum package	m ³	pezzi pallet pcs pallet	m ³
11 464 080	80	a80 b40 c42	d74 e34 f42	66	2 80x40x71h	0,22	12 80x120x112h	1,08



Pasubio alto



Superficie opaca
Matt finished
Surface opaque
Matt-Oberfläche



201

cappuccino/cappuccino
cappuccino/cappuccino



032

antracite/anthracite
anthracite/anthrazitgrau

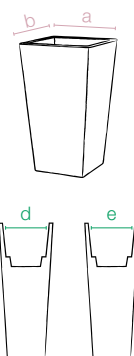

codice senza colore code without colour	Cm	dimensioni esterne external dimensions	dimensioni interne internal dimensions	litri liters	Confezione minima Minimum package	pezzi pallet pcs pallet	accessori accessories
11 462 070	70	a40 b40 c68	d34 e34 f25	31	1 40x40x70h 0,11	24 80x120x210h 2,02	
11 462 100	100	a40 b40 c100	d34 e34 f25	32	1 40x40x100h 0,16	12 80x120x212h 2,04	

Fix Ground
Fix Wall
pagina 226

Pasubio Alto,
Quadro e Cassa
componibili
modular
modulable
zusammensetzbar

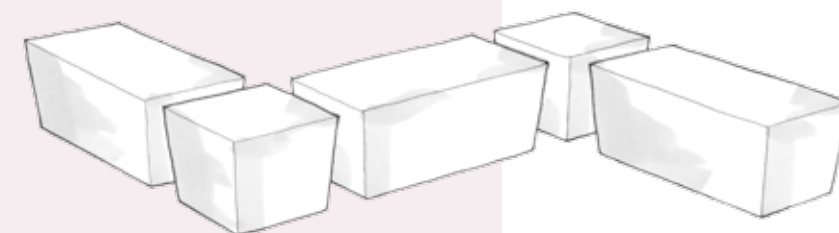

Pasubio Alto, Pasubio Quadro e Pasubio Cassa si prestano molto bene per organizzare gli spazi

Pasubio Quadro and Pasubio Cassa lend very well to organize spaces

Pasubio Quadro et Pasubio Cassa se prêtent très bien pour l'organisation des espaces

Pasubio Quadro und Pasubio Cassa sind ideal für die Organization der Räume

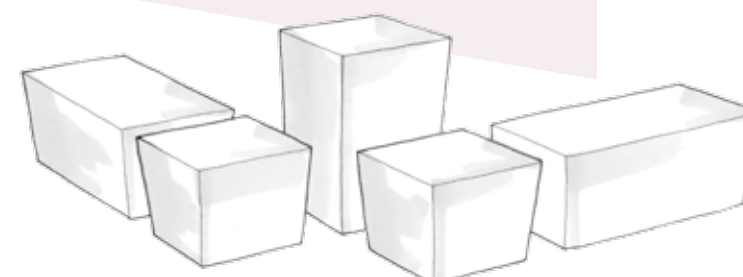
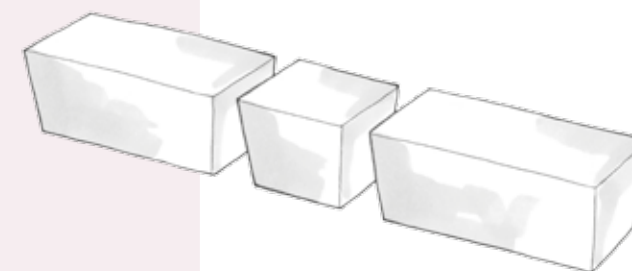
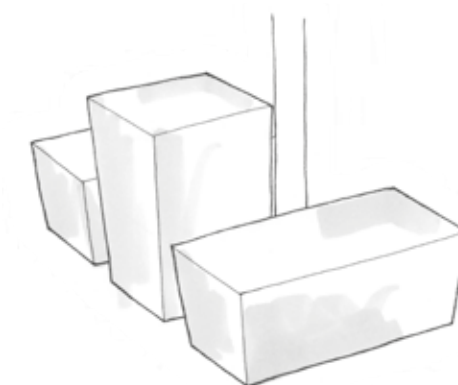



Schio ciotola



Superficie opaca
Matt finished
Surface opaque
Matt-Oberfläche

Valentino

Superficie opaca / Matt finished
Surface opaque / Matt-Oberfläche

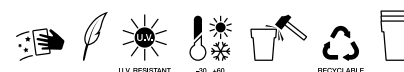

043
bianco/white
blanc/weiß



201
cappuccino/cappuccino
cappuccino/cappuccino



032
antracite/anthracite
anthracite/anthrazitgrau



050
rosso cardinale/cardinal red
rouge cardinal/scharlachrot

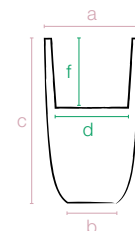

codice senza colore code without colour	Cm	dimensioni esterne external dimensions			dimensioni interne internal dimensions		litri liters	Confezione minima Minimum package	m ³	pezzi pallet pcs pallet	m ³	accessori accessories
11 432 050	50	a34	b21	c50	d26	f22	10	2 34x68x50h	0,11	16 80x120x112h	1,08	
11 432 070	70	a42	b25	c70	d32	f28	17	1 42x42x70h	0,12	18 80x120x226h	2,17	
11 432 090	90	a52	b30	c90	d40	f28	29	1 52x52x90h	0,24	8 100x120x195h	2,34	

Fix Ground - Fix Wall
pagina 226

Bassano

Superficie opaca / Matt finished
Surface opaque / Matt-Oberfläche

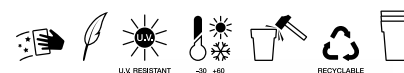

043
bianco/white
blanc/weiß



201
cappuccino/cappuccino
cappuccino/cappuccino



032
antracite/anthracite
anthracite/anthrazitgrau



050
rosso cardinale/cardinal red
rouge cardinal/scharlachrot

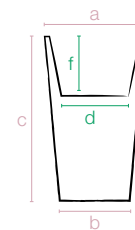

codice senza colore code without colour	Cm	dimensioni esterne external dimensions			dimensioni interne internal dimensions		litri liters	Confezione minima Minimum package	m ³	pezzi pallet pcs pallet	m ³	accessori accessories
11 423 060	60	a36	b29	c60	d27	f20	10	1 45x45x60h	0,12	24 80x120x202h	1,94	
11 423 100	100	a48	b35	c100	d35	f34	20	1 60x60x100h	0,36	6 100x120x165h	1,58	

Fix Ground - Fix Wall
pagina 226



043
bianco/white
blanc/weiß



201
cappuccino/cappuccino
cappuccino/cappuccino



032
antracite/anthracite
anthracite/anthrazitgrau



050
rosso cardinale/cardinal red
rouge cardinal/scharlachrot



039
bronzo/bronze
bronze/bronze



030
anticato/light brown
marron clair/hellbraun

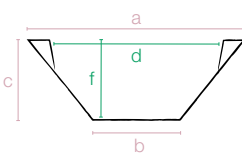

codice senza colore code without colour	Cm	dimensioni esterne external dimensions			dimensioni interne internal dimensions		litri liters	Confezione minima Minimum package	m ³	pezzi pallet pcs pallet	m ³
11 433 060	60	a60	b24,5	c22	d48	e21	22	2 60x60x30h	0,10	26 80x120x113h	1,08
11 433 080	80	a80	b32,5	c29	d64,5	e28	54	2 80x80x39h	0,25	10 80x80x113h	0,72
11 433 100	100	a100	b40	c37	d80	e36	106	1 100x100x37h	0,37	7 100x120x113h	1,36



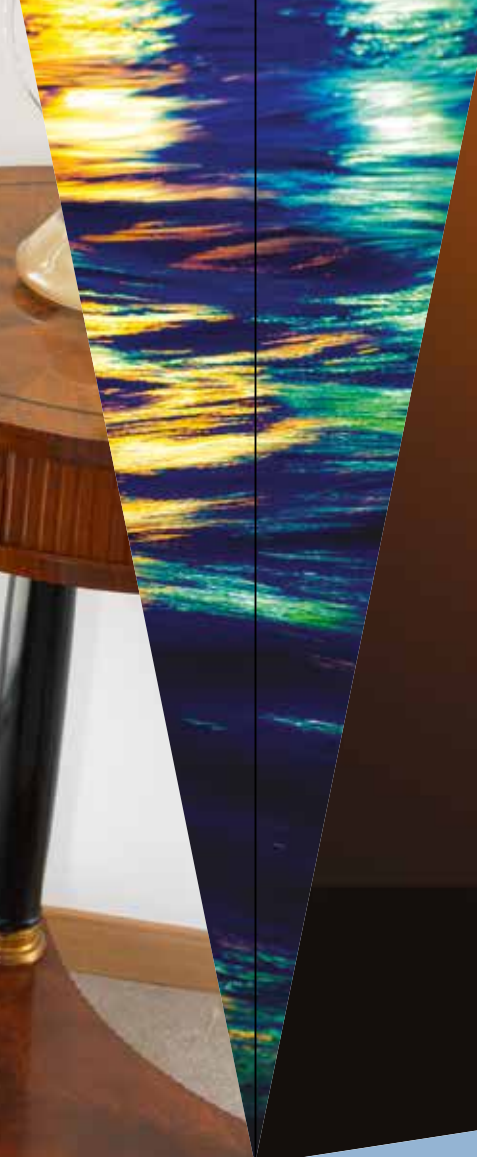

SELF WATERING

SELF WATERING



Divio



Schio Cubo



Schio Cassa

Essential Self Watering



Riserva d'acqua

La riserva d'acqua permette di alimentare le vostre piante senza bisogno di irrigarle spesso. I fori di drenaggio per il "troppo pieno" permettono di scaricare eventuali eccessi di acqua così sarà la pianta stessa ad attingere alla riserva d'acqua quando ne avrà bisogno.

Water reserve

The water reservoir allows to feed your plants without having to water it often. The drainage holes for the "overflow" allow you to download any excess water so the plant itself will be to draw on the reserve of water when it needs them. Some of the pots equipped with this system also have a coating membrane that, once removed, it allows excess water to leak from the pots.

Avec reserve de l'eau

Le réservoir d'eau permet de nourrir vos plantes sans avoir à les arroser souvent. Les trous de drainage pour le «débordement» vous permettent de télécharger tout excès d'eau de sorte que sera elle-même à puiser dans la réserve d'eau quand il en aura besoin. Certains des pots équipés de ce système ont également une membrane d'enrobage qui, une fois enlevé, permet à l'eau en excès de sortir

Wasser reservoir

Das Wasser-Reservoir ermöglicht, Ihre Pflanzen zu versorgen, ohne ständig Wasser zuzuführen. Die Entwässerungslöcher lassen das Wasser überlaufen, damit die Pflanze das nach Bedarf schöpfen kann. Einige Pflanzgefäße mit Wasserspeicher besitzen eine Abdeckung-Membrane, die das Wasser, bei Wegnahme, überlaufen lässt.

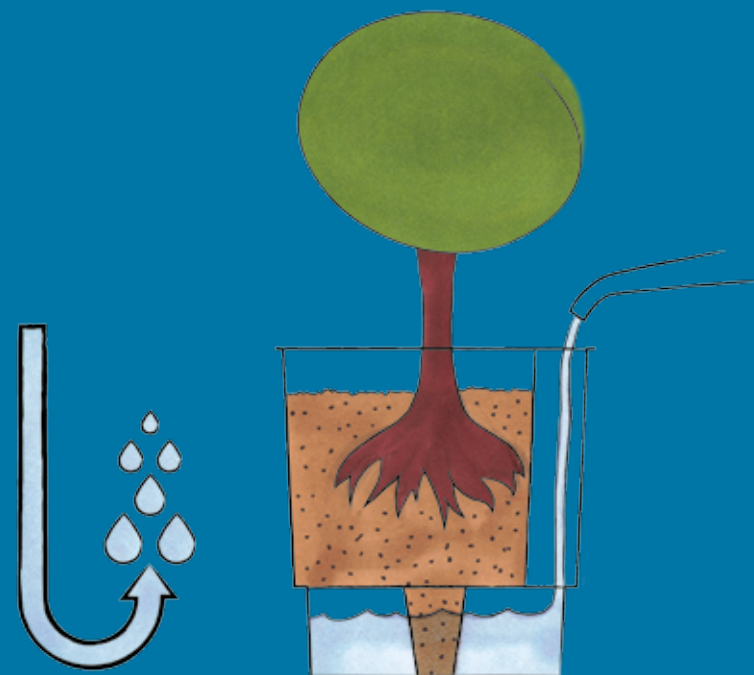

Divio self watering



043
bianco/white
blanc/weiß



201
cappuccino/cappuccino
cappuccino/cappuccino



210
grafite/graphite
graphite/graphit



232
kiwi/kiwi
kiwi/Kiwi

colour on demand 030 050 211 202 068 203 208 230 233 234 204 049 204 039

codice senza colore code without colour	Cm	dimensioni esterne external dimensions	Confezione minima Minimum package	pezzi pallet pcs pallet
16 466 080	80	a90 b27 c77	1 91x28x79h	0,2 8 80x120x201h 1,93

diffusione dell'acqua per osmosi
water diffusion through osmosis's effect
diffusion de l'eau par osmose
Wasserdiffusion durch Osmose

riserva d'acqua
water reserve
réserve d'eau
Wasser-Reservoir

beccuccio per inserimento dell'acqua
spout for water insertion
bec pour l'introduction de l'eau
Füllschacht zur Wasserversorgung

griglia di drenaggio
drainage grid
gril pour le drainage
Bewässerungseinsatz

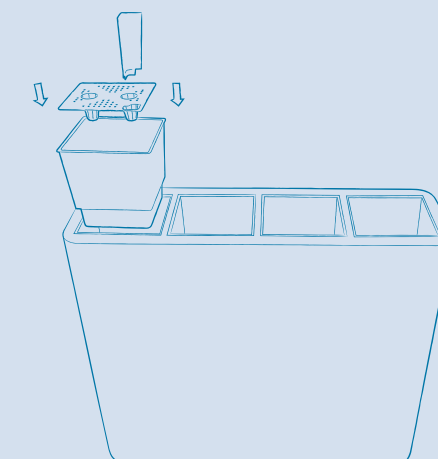
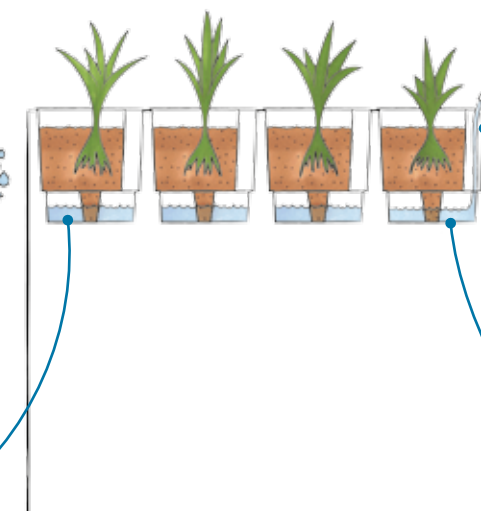

Schio cubo self watering



043 bianco/white
blanc/weiß

201 cappuccino/cappuccino
cappuccino/cappuccino

032 antracite/anthracite
anthracite/anthrazitgrau

050 rosso cardinale/cardinal red
rouge cardinal/scharlachrot

039 bronzo/bronze
bronze/bronze

codice senza colore code without colour	Cm	dimensioni esterne external dimensions	Confezione minima Minimum package	pezzi pallet pcs pallet	m ³
16 425 030	30	a:30 b:30 c:28	1 30x30x30h	24	0,02 80x120x115h 1,10

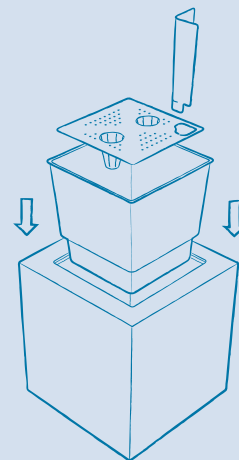
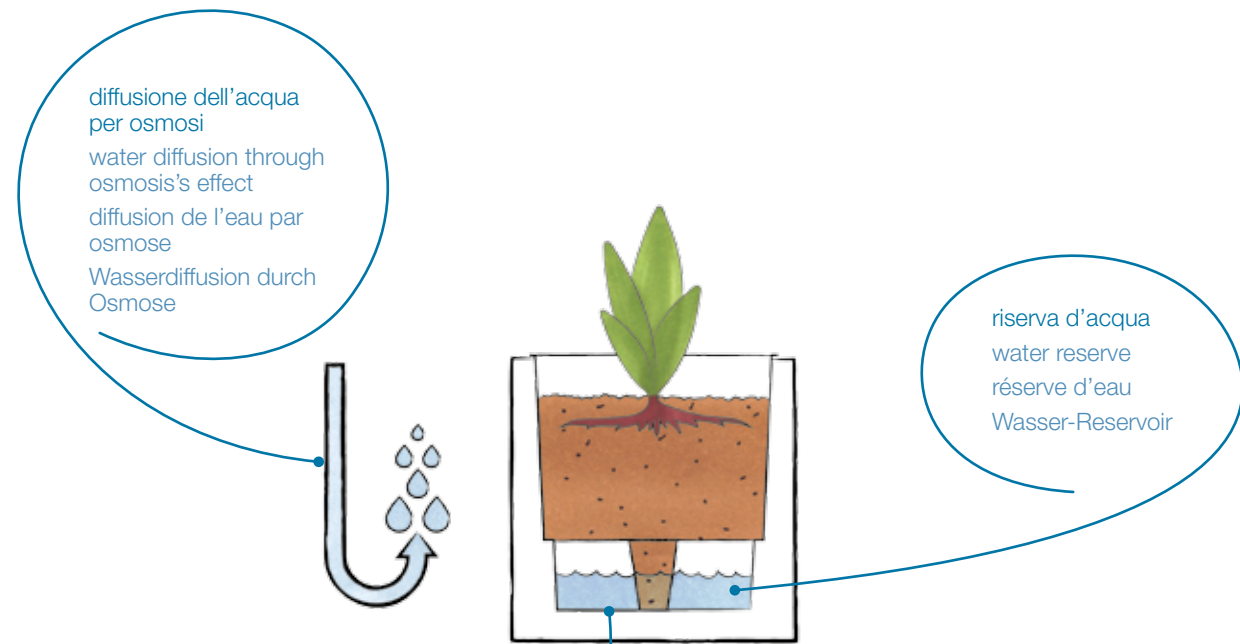

Schio cassa self watering



043 bianco/white
blanc/weiß

201 cappuccino/cappuccino
cappuccino/cappuccino

032 antracite/anthracite
anthracite/anthrazitgrau

050 rosso cardinale/cardinal red
rouge cardinal/scharlachrot

039 bronzo/bronze
bronze/bronze

codice senza colore code without colour	Cm	dimensioni esterne external dimensions	Confezione minima Minimum package	pezzi pallet pcs pallet	m ³
16 427 080	80	a:80 b:30 c:30	2 80x30x30h	28	0,07 80x120x222h 2,13

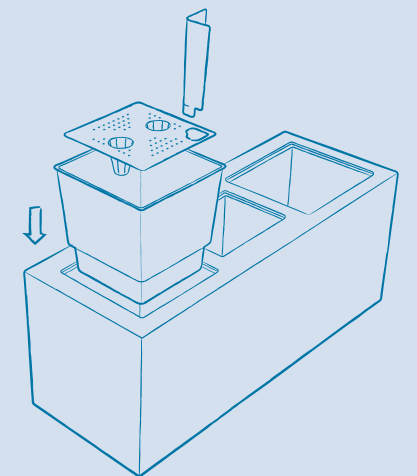
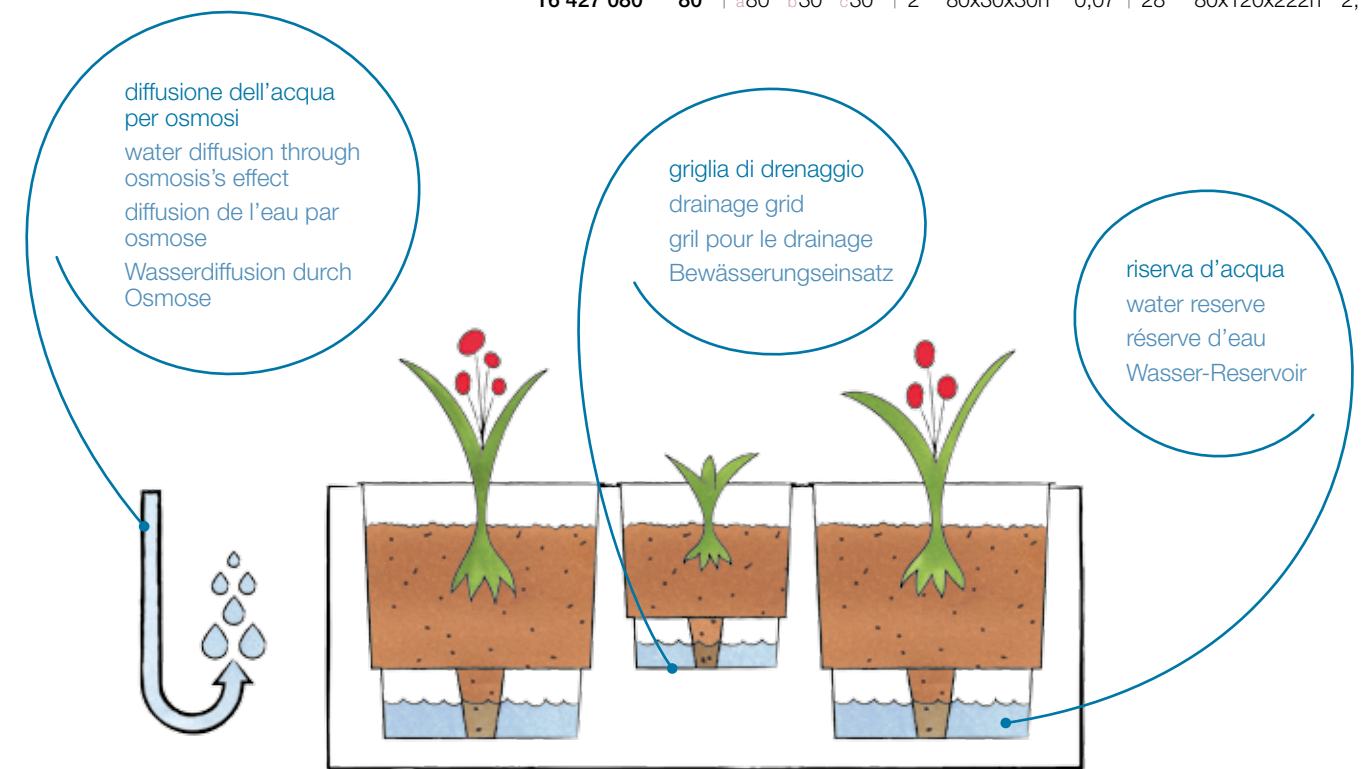



linea
CLASSIC



Flora



Cilindro Vicenza



Cassetta Liscia



Quadro Liscio



Africa

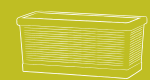

Cassetta Millerighe



Quadro Millerighe



Ciotola Castello



Conca Classica



Vaso Muro Righe



Tulipano



Vaso Festonato



Vaso Doppio Bordo



Campana Chiampo



Cassetta Leonardo



Vaso Muro Liscio



Sottovaso Muro



Sottovaso Tondo



Sottovaso Quadro



Sottocassetta



Superficie opaca
Matt finished
Surface opaque
Matt-Oberfläche



Superficie opaca
Matt finished
Surface opaque
Matt-Oberfläche



Flora

cilindro Vicenza



030

anticato/light brown
marron clair/hellbraun



201

cappuccino/cappuccino
cappuccino/cappuccino



032

antracite/anthracite
anthracite/anthrazitgrau



Sottovaso
pagina 202



030

anticato/light brown
marron clair/hellbraun



201

cappuccino/cappuccino
cappuccino/cappuccino



032

antracite/anthracite
anthracite/anthrazitgrau



Sottovaso
pagina 202

Predisposto per ruote
Prearranged for rollers
Prévu pour roues
Vorgesehen für Räder

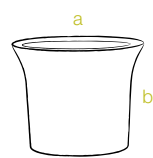

codice senza colore code without colour	Cm	dimensioni dimensions	litri liters		Confezione minima Minimum package	m³	pezzi pallet pcs pallet	m³
02 441 040	40	a40 b33	26	37	4 40x40x53h	0,08	72 80x120x115h	1,10
02 441 045	45	a45 b38	34	40	2 45x45x44h	0,08	125 100x120x224h	2,69
02 441 050	50	a50 b41	47	47	2 50x50x49h	0,12	64 100x120x220h	2,64



codice senza colore code without colour	Cm	dimensioni dimensions	litri liters		Confezione minima Minimum package	m³	pezzi pallet pcs pallet	m³	accessori accessories
02 443 040	40	a40 b30	26	37	4 40x40x51h	0,08	66 80x120x115h	1,10	
02 443 045	45	a45 b34	40	40	2 45x45x41h	0,08	75 80x120x220h	2,11	
02 443 050	50	a50 b38	52	47	2 50x50x46h	0,11	66 100x120x225h	2,70	
02 443 060	60	a60 b45	94	54	2 60x60x55h	0,19	34 80x120x214h	2,05	
02 443 070	70	a70 b53	145	66	1 70x70x53h	0,26	15 80x80x224h	1,43	



Superficie opaca
Matt finished
Surface opaque
Matt-Oberfläche



casetta Liscia



030

anticato/light brown
marron clair/hellbraun

201

cappuccino/cappuccino
cappuccino/cappuccino

032

antracite/anthracite
anthracite/anthrazitgrau

Sottocassetta
pagina 203

Predisposto per ruote
Prearranged for rollers
Prévu pour roues
Vorgesehen für Räder



Superficie opaca
Matt finished
Surface opaque
Matt-Oberfläche



quadro Liscio



030

anticato/light brown
marron clair/hellbraun

201

cappuccino/cappuccino
cappuccino/cappuccino

032

antracite/anthracite
anthracite/anthrazitgrau

Sottovaso
pagina 203

Predisposto per ruote
Prearranged for rollers
Prévu pour roues
Vorgesehen für Räder

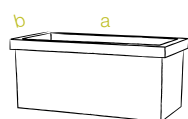
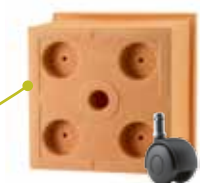

codice senza colore code without colour	Cm	dimensioni dimensions	litri liters	Confezione minima Minimum package	m ³	pezzi pallet pcs pallet	m ³	accessori accessories
02 444 080	80	a 80 b 40 c 35	78	2 80x40x70h	0,22	18 80x120x224h	2,15	
02 444 100	100	a 100 b 46 c 41	133	2 100x46x82h	0,37	10 100x120x220h	2,64	

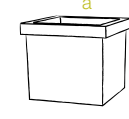

codice senza colore code without colour	Cm	dimensioni dimensions	litri liters	Confezione minima Minimum package	m ³	pezzi pallet pcs pallet	m ³	accessori accessories
02 445 040	40	a 40 b 40 c 35	35	2 40x40x70h	0,11	18 80x120x117h	1,12	
02 445 046	46	a 46 b 46 c 41	56	2 46x46x82h	0,17	20 100x120x219h	2,63	
02 445 055	55	a 55 b 55 c 48	95	2 55x55x48h	0,29	16 120x120x207h	2,98	

Africa

Superficie opaca / Matt finished
Surface opaque / Matt-Oberfläche



030

anticato/light brown
marron clair/hellbraun



201

cappuccino/cappuccino
cappuccino/cappuccino



032

antracite/anthracite
anthracite/anthrazitgrau

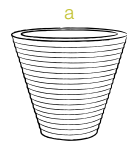

codice senza colore code without colour	Cm	dimensioni dimensions	litri liters	Confezione minima Minimum package	m ³	pezzi pallet pcs pallet	m ³
02 418 080	80	a 80 b 69	82	1 80x80x70h	0,44	5 80x80x213h	1,36
02 418 105	105	a 105 b 90	161	1 105x105x90h	0,99	4 100x120x238h	2,86

Tulipano

Superficie opaca / Matt finished
Surface opaque / Matt-Oberfläche



030

anticato/light brown
marron clair/hellbraun



201

cappuccino/cappuccino
cappuccino/cappuccino



032

antracite/anthracite
anthracite/anthrazitgrau



codice senza colore code without colour	Cm	dimensioni dimensions	litri liters	Confezione minima Minimum package	m ³	pezzi pallet pcs pallet	m ³	accessori accessories
02 419 110	110	a 62,5 b 110	65	1 65x65x110h	0,46	6 100x120x230h	2,76	

Fix Ground
Fix Wall
pagina 226

vaso Festonato

Superficie opaca / Matt finished
Surface opaque / Matt-Oberfläche

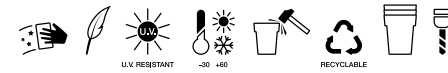

030

anticato/light brown
marron clair/hellbraun



201

cappuccino/cappuccino
cappuccino/cappuccino



032

antracite/anthracite
anthracite/anthrazitgrau



Sottovaso
pagina 202



codice senza colore code without colour	Cm	dimensioni dimensions	litri liters	Confezione minima Minimum package	m ³	pezzi pallet pcs pallet	m ³
02 400 030	30	a 30 b 16 c 25	8	22 4 30x30x46h	0,04	96 80x120x113h	1,08
02 400 035	35	a 35 b 20 c 29,5	15	27 4 35x35x52h	0,06	66 80x120x112h	1,08
02 400 040	40	a 40 b 22 c 35	22	30 4 40x40x61h	0,09	54 80x120x112h	1,08
02 400 045	45	a 45 b 40 c 39	34	33 2 45x45x48h	0,09	88 80x120x220h	2,11
02 400 050	50	a 50 b 28 c 43	46	37 2 50x50x52h	0,13	80 100x120x222h	2,66
02 400 055	55	a 55 b 32 c 48	67	40 2 55x55x59h	0,17	40 80x120x224h	2,15
02 400 060	60	a 60 b 35 c 50	84	47 2 60x60x62h	0,22	30 80x120x226h	2,07
02 400 070	70	a 70 b 40 c 58	123	47 1 70x70x59h	0,28	14 80x80x224h	1,43
02 400 080	80	a 80 b 43 c 63	245	50 1 80x80x63h	0,40	13 80x80x217h	1,39

vaso doppio bordo

Superficie opaca / Matt finished
Surface opaque / Matt-Oberfläche



030

anticato/light brown
marron clair/hellbraun



201

cappuccino/cappuccino
cappuccino/cappuccino



032

antracite/anthracite
anthracite/anthrazitgrau



Sottovaso
pagina 202

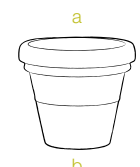

codice senza colore code without colour	Cm	dimensioni dimensions	litri liters	Confezione minima Minimum package	m ³	pezzi pallet pcs pallet	m ³
02 401 030	30	a 30 b 16,5 c 25	8	22 4 30x30x46h	0,04	96 80x120x115h	1,10
02 401 035	35	a 35 b 20 c 29	15	27 4 35x35x52h	0,06	60 80x120x113h	1,08
02 401 040	40	a 40 b 22 c 35	22	30 4 40x40x61h	0,09	48 80x120x112h	1,08
02 401 045	45	a 45 b 26 c 39	34	33 2 45x45x48h	0,09	80 80x120x220h	2,11
02 401 050	50	a 50 b 29 c 43	45	37 2 50x50x52h	0,13	76 100x120x228h	2,74
02 401 055	55	a 55 b 33 c 48	67	40 2 55x55x59h	0,17	36 80x120x220h	2,11
02 401 060	60	a 60 b 35 c 53	85	47 2 60x60x62h	0,22	30 80x120x219h	2,10
02 401 070	70	a 70 b 40 c 58	125	47 1 70x70x59h	0,28	14 80x80x219h	1,40
02 401 085	85	a 85 b 52,5 c 70	232	60 1 85x85x70h	0,50	11 100x120x215h	1,58

campana Chiampo

Superficie opaca / Matt finished
Surface opaque / Matt-Oberfläche



030
anticato/light brown
marron clair/hellbraun



201
cappuccino/cappuccino
cappuccino/cappuccino



032
antracite/anthracite
anthracite/anthrazitgrau



Sottovaso
pagina 202

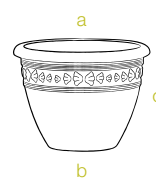

codice senza colore code without colour	Cm	dimensioni dimensions	litri liters	Confezione minima Minimum package	m ³	pezzi pallet pcs pallet	m ³
02 403 030	30	a30 b25,5 c23	8	4 30x30x51h	0,04	72 80x120x115h	1,10
02 403 040	40	a40 b33 c30	18	4 40x40x66h	0,10	42 80x120x115h	1,10
02 403 060	60	a60 b50 c47	65	4 60x60x67h	0,24	22 80x120x223h	2,23

cassetta Millerighe

Superficie opaca / Matt finished
Surface opaque / Matt-Oberfläche

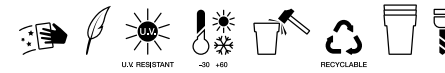

030
anticato/light brown
marron clair/hellbraun



201
cappuccino/cappuccino
cappuccino/cappuccino



032
antracite/anthracite
anthracite/anthrazitgrau



Sottocassetta
pagina 203

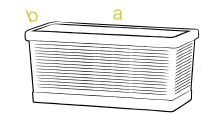

codice senza colore code without colour	Cm	dimensioni dimensions	litri liters	Confezione minima Minimum package	m ³	pezzi pallet pcs pallet	m ³
02 408 060	60	a59 b27 c27,6	32	2 59x27x56h	0,08	48 80x120x229h	2,20
02 408 080	80	a79 b34 c34	70	2 79x34x68h	0,18	18 80x120x221h	2,12
02 408 094	94	a94 b40 c38	130	2 94x40x76h	0,28	10 100x120x202h	2,42
02 408 100	100	a100 b44 c40	146	2 100x44x80h	0,35	10 100x120x228h	2,74

cassetta Leonardo

Superficie opaca / Matt finished
Surface opaque / Matt-Oberfläche



030
anticato/light brown
marron clair/hellbraun



201
cappuccino/cappuccino
cappuccino/cappuccino



032
antracite/anthracite
anthracite/anthrazitgrau



Sottocassetta
pagina 203

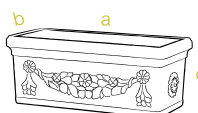

codice senza colore code without colour	Cm	dimensioni dimensions	litri liters	Confezione minima Minimum package	m ³	pezzi pallet pcs pallet	m ³
02 406 060	60	a58 b29 c27	29	2 58x29x54h	0,09	48 80x120x220h	2,11
02 406 080	80	a80 b34 c32	57	2 80x34x64h	0,17	18 80x120x202h	1,94
02 406 100	100	a100 b45 c40	120	2 100x45x80h	0,36	10 100x120x212h	2,54

quadro Millerighe

Superficie opaca / Matt finished
Surface opaque / Matt-Oberfläche



030
anticato/light brown
marron clair/hellbraun



201
cappuccino/cappuccino
cappuccino/cappuccino



032
antracite/anthracite
anthracite/anthrazitgrau



Sottovaso
pagina 203

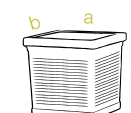

codice senza colore code without colour	Cm	dimensioni dimensions	litri liters	Confezione minima Minimum package	m ³	pezzi pallet pcs pallet	m ³
02 409 035	35	a35 b35 c34,6	28	2 35x35x70h	0,08	36 80x120x218h	2,09
02 409 040	40	a40 b40 c39,6	41	2 40x40x80h	0,12	30 80x120x207h	1,99
02 409 045	45	a45 b45 c40,1	59	2 45x45x81h	0,16	20 100x120x235h	2,82

ciotola **Castello**

Superficie opaca / Matt finished
Surface opaque / Matt-Oberfläche



030

anticato/light brown
marron clair/hellbraun



201

cappuccino/cappuccino
cappuccino/cappuccino



032

antracite/anthracite
anthracite/anthrazitgrau



codice senza colore code without colour	Cm	dimensioni dimensions	litri liters	Confezione minima Minimum package	m ³	pezzi pallet pcs pallet	m ³
02 405 050	50	a50 b22	24	2 50x50x33h	0,08	32 80x120x115h	1,10
02 405 060	60	a60 b24,5	42	2 60x60x40h	0,14	12 80x120x115h	1,10
02 405 080	80	a80 b35	97	1 80x80x35h	0,22	11 80x80x210h	1,34

vaso **Muro righe**

Superficie opaca / Matt finished
Surface opaque / Matt-Oberfläche



030

anticato/light brown
marron clair/hellbraun



201

cappuccino/cappuccino
cappuccino/cappuccino



032

antracite/anthracite
anthracite/anthrazitgrau

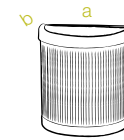

codice senza colore code without colour	Cm	dimensioni dimensions	Confezione minima Minimum package	m ³	pezzi pallet pcs pallet	m ³
02 413 048	48	a48 b32 c52	53	1 48x32x52h	0,08	14 100x120x118h 1,42

conca **Classica**

Superficie opaca / Matt finished
Surface opaque / Matt-Oberfläche



030

anticato/light brown
marron clair/hellbraun



201

cappuccino/cappuccino
cappuccino/cappuccino



032

antracite/anthracite
anthracite/anthrazitgrau



codice senza colore code without colour	Cm	dimensioni dimensions	litri liters	Confezione minima Minimum package	m ³	pezzi pallet pcs pallet	m ³
02 412 120	120	a120 b94	541	1 120x120x95h	1,36	6 120x120x197h	2,84

vaso **Muro liscio**

Superficie opaca / Matt finished
Surface opaque / Matt-Oberfläche



030

anticato/light brown
marron clair/hellbraun



201

cappuccino/cappuccino
cappuccino/cappuccino



032

antracite/anthracite
anthracite/anthrazitgrau



codice senza colore code without colour	Cm	dimensioni dimensions	Confezione minima Minimum package	m ³	pezzi pallet pcs pallet	m ³
02 414 050	48	a48 b32 c52	53	1 48x32x52h	0,08	14 100x120x118h 1,42

sottovaso Muro

Superficie opaca / Matt finished
Surface opaque / Matt-Oberfläche



030

anticato/light brown
marron clair/hellbraun



201

cappuccino/cappuccino
cappuccino/cappuccino



032

antracite/anthracite
anthracite/anthrazitgrau

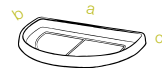

codice senza colore code without colour	Cm	dimensioni dimensions	Confezione minima Minimum package	m ³	pezzi pallet pcs pallet	m ³
02 429 053	53	a53 b38 c4,5	1 53x38x5h	0,01	135 80x120x115h	1,10

sottovaso Quadro

Superficie opaca / Matt finished
Surface opaque / Matt-Oberfläche



043

bianco/white
blanc/weiß



030

anticato/light brown
marron clair/hellbraun



201

cappuccino/cappuccino
cappuccino/cappuccino



032

antracite/anthracite
anthracite/anthrazitgrau

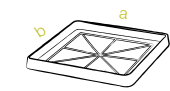

codice senza colore code without colour	Cm	dimensioni dimensions	Confezione minima Minimum package	m ³	pezzi pallet pcs pallet	m ³
02 417 030	30	a30 b30 c5	2 30x30x7h	0,01	270 80x120x115h	1,10
02 417 036	36	a41 b41 c5	2 41x41x7h	0,01	270 80x120x115h	1,10
02 417 046	46	a46 b46 c5	2 46x46x7h	0,01	80 80x120x115h	1,10
02 417 056	56	a56 b56 c5	2 56x56x7h	0,02	80 80x120x115h	1,10

sottovaso Tondo

Superficie opaca / Matt finished
Surface opaque / Matt-Oberfläche



043

bianco/white
blanc/weiß



030

anticato/light brown
marron clair/hellbraun



201

cappuccino/cappuccino
cappuccino/cappuccino



032

antracite/anthracite
anthracite/anthrazitgrau

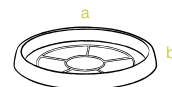

codice senza colore code without colour	Cm	dimensioni dimensions	Confezione minima Minimum package	m ³	pezzi pallet pcs pallet	m ³
02 415 022	22	a22 b4	10 22x22x18h	0,01	600 80x120x115h	1,10
02 415 027	27	a27 b4	10 27x27x22h	0,01	550 80x120x115h	1,10
02 415 030	30	a30 b4	8 30x30x15h	0,01	320 80x120x115h	1,10
02 415 033	33	a33 b4	8 33x33x15h	0,02	336 80x120x115h	1,10
02 415 037	37	a37 b4	8 37x37x15h	0,02	288 80x120x115h	1,10
02 415 040	40	a40 b5	8 40x40x15h	0,03	288 80x120x115h	1,10
02 415 047	47	a47 b5	6 47x47x14h	0,03	180 80x120x115h	1,10
02 415 050	50	a50 b5	6 50x50x14h	0,03	180 80x120x115h	1,10
02 415 054	54	a54 b5	4 54x54x11h	0,03	120 80x120x115h	1,10
02 415 060	60	a60 b5	4 60x60x11h	0,04	92 80x120x115h	1,10
02 415 066	66	a66 b6	2 66x66x13h	0,05	46 80x120x115h	1,10

Sottocassetta

Superficie opaca / Matt finished
Surface opaque / Matt-Oberfläche



043

bianco/white
blanc/weiß



030

anticato/light brown
marron clair/hellbraun

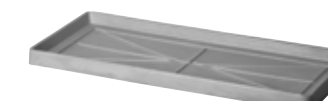

201

cappuccino/cappuccino
cappuccino/cappuccino



032

antracite/anthracite
anthracite/anthrazitgrau



codice senza colore code without colour	Cm	dimensioni dimensions	Confezione minima Minimum package	m ³	pezzi pallet pcs pallet	m ³
02 416 060	60	a60 b30 c5	2 60x31x7h	0,01	120 80x120x115h	1,10
02 416 080	80	a80 b36 c5	2 80x36x7h	0,02	80 80x120x115h	1,10
02 416 100	100	a100 b45 c5	2 100x45x7h	0,03	45 80x120x115h	1,10



linea
CITY



New York



Venezia



Roma

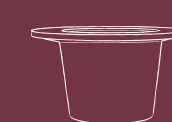

A-Malo



Superficie opaca
Matt finished
Surface opaque
Matt-Oberfläche



New York

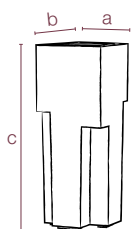
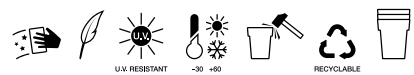

codice senza colore code without colour	Cm	dimensioni esterne external dimensions	Confezione minima Minimum package	m ³	pezzi pallet pcs pallet	m ³	accessori accessories
20 454 100	043 037 100	a39 b39 c100	1 40x40x102h	0,16	12 80x120x215h	2,06	

Fix Wall
pagina 227



Superficie opaca
Matt finished
Surface opaque
Matt-Oberfläche



Venezia

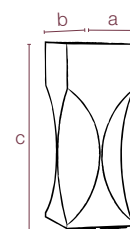
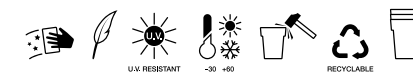

codice senza colore code without colour	Cm	dimensioni esterne external dimensions	Confezione minima Minimum package	m ³	pezzi pallet pcs pallet	m ³	accessori accessories
20 459 100	043 037 100	a39 b39 c100	1 40x40x102h	0,16	12 80x120x215h	2,06	

Fix Wall
pagina 227



Superficie opaca
Matt finished
Surface opaque
Matt-Oberfläche



Roma

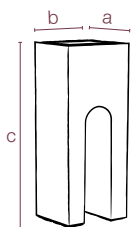
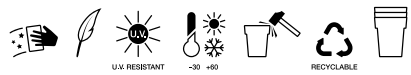

codice senza colore code without colour	Cm	dimensioni esterne external dimensions	Confezione minima Minimum package	m ³	pezzi pallet pcs pallet	m ³	accessori accessories
20 455 100	043 037 100	a39 b39 c100	1 40x40x102h	0,16	12 80x120x215h	2,06	

Fix Wall
pagina 227



Superficie opaca
Matt finished
Surface opaque
Matt-Oberfläche



A-malo

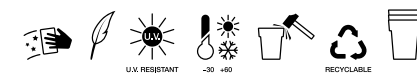

Sistema di aggancio
Coupling system
Système d'accrochage
Aufhäng System



Articolo composto da due pezzi per agevolare il trasporto
The item is made up of two components to facilitate the transport
Article composé de 2 pièces pour faciliter le transport
Artikel besteht aus zwei teilen um der Transport zu erleichtern

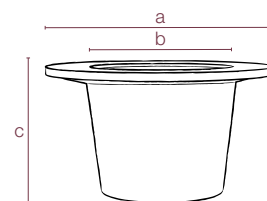

codice senza colore code without colour	Cm	dimensioni dimensions	Confezione minima Minimum package
20 458 150 vaso	043 037 150	b108 c110	1
20 452 150 anello	043 037 150	a150 c8	1
20 458 220 vaso	043 037 220	b158 c120	1
20 452 220 anello	043 037 220	a220 c10	1



LINEA
LUCE

linea
LUCE



Standard One
Outdoor



Spritz



Africa Outdoor



Tulipano Outdoor



Valentino
Outdoor



Pasubio Alto
Outdoor



Bassano
Outdoor

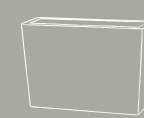

Schio Cassa Alta
Outdoor



Schio Cubo Alto
Outdoor



Schio Cono
Outdoor



Superficie opaca
Matt finished
Surface opaque
Matt-Oberfläche



Standard one outdoor



Superficie opaca
Matt finished
Surface opaque
Matt-Oberfläche



Spritz

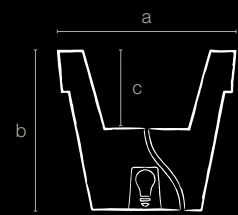

caratteristiche lampada: attacco E27, tensione max 220, potenza max 11 W, tipo risp. energ. standard
lamp characteristics: electrical coupling E27, max voltage 220, max electrical power 11 W, standard energy saving type lamp
caractéristiques de l'ampoule: culot E27, tension max 220, puissance max 11W, type économie d'énergie standard
charakteristik der Lampe E27 Fassung, max. 220 Volt max. 11 W. Energiesparlampe Typ Standard

Fix Wall
pagina 227

codice senza colore code without colour	Cm	dimensioni dimensions			litri liters	Confezione minima Minimum package	m ³	pezzi pallet pcs pallet	m ³	accessori accessories
13 437 070	033 70	a70	b63	c17	43	1 70x70x63h	0,30	4 80x80x220h	1,40	
13 437 080	033 80	a80	b72	c19	67	1 80x80x72h	0,40	4 80x80x220h	1,40	
13 437 100	033 100	a100	b90	c24	123	1 100x100x90h	0,90	3 100x120x220h	2,60	
13 437 120	033 120	a120	b108	c30	191	1 120x120x108h	1,50	2 120x120x220h	3,10	

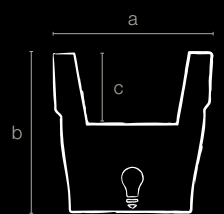
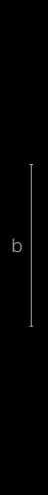

caratteristiche lampada: attacco E27, tensione max 220, potenza max 11 W, tipo risp. energ. standard
lamp characteristics: electrical coupling E27, max voltage 220, max electrical power 11 W, standard energy saving type lamp
caractéristiques de l'ampoule: culot E27, tension max 220, puissance max 11W, type économie d'énergie standard
charakteristik der Lampe E27 Fassung, max. 220 Volt max. 11 W. Energiesparlampe Typ Standard

Fix Wall
pagina 227

codice senza colore code without colour	Cm	dimensioni dimensions			litri liters	Confezione minima Minimum package	m ³	pezzi pallet pcs pallet	m ³	accessori accessories
05 446 038	033 38	a38	b35	c16,5	43	1 40x40x63h	0,06	18 80x120x130h	1,20	



Superficie opaca
Matt finished
Surface opaque
Matt-Oberfläche



Africa outdoor



Superficie opaca
Matt finished
Surface opaque
Matt-Oberfläche



Tulipano outdoor

caratteristiche lampada: attacco E27, tensione max 220, potenza max 11 W, tipo risp. energ. standard

lamp characteristics: electrical coupling E27, max voltage 220, max electrical power 11 W, standard energy saving type lamp

caractéristiques de l'ampoule: culot E27, tension max 220, puissance max 11W, type économie d'énergie standard

charakteristik der Lampe E27 Fassung, max. 220 Volt max. 11 W. Energiesparlampe Typ Standard

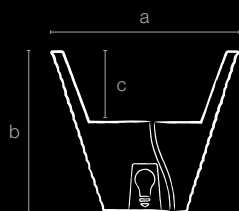

codice senza colore code without colour	Cm	dimensioni dimensions	litri liters	Confezione minima Minimum package	m ³	pezzi pallet pcs pallet	m ³
13 418 080 ⁰³³	80	a 80 b 69 c 36	82	1 80x80x70h	0,40	5 80x80x216h	1,40
13 418 105 ⁰³³	105	a 105 b 90 c 42	161	1 80x80x72h	1,00	4 100x120x238h	2,90

caratteristiche lampada: attacco E27, tensione max 220, potenza max 11 W, tipo risp. energ. standard

lamp characteristics: electrical coupling E27, max voltage 220, max electrical power 11 W, standard energy saving type lamp

caractéristiques de l'ampoule: culot E27, tension max 220, puissance max 11W, type économie d'énergie standard

charakteristik der Lampe E27 Fassung, max. 220 Volt max. 11 W. Energiesparlampe Typ Standard

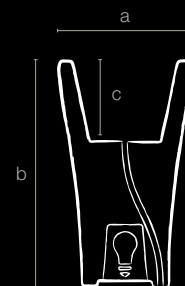

codice senza colore code without colour	Cm	dimensioni dimensions	litri liters	Confezione minima Minimum package	m ³	pezzi pallet pcs pallet	m ³	accessori accessories
13 419 110 ⁰³³	110	a 65 b 110 c 39	65	1 65x65x110h	0,50	6 100x120x230h	0,76	

Fix Wall
pagina 227





Superficie opaca
Matt finished
Surface opaque
Matt-Oberfläche

Valentino outdoor



Superficie opaca
Matt finished
Surface opaque
Matt-Oberfläche

Pasubio alto outdoor

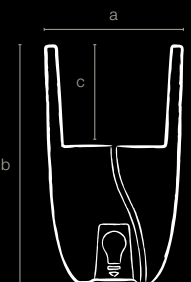

caratteristiche lampada: attacco E27, tensione max 220, potenza max 11 W, tipo risp. energ. standard
lamp characteristics: electrical coupling E27, max voltage 220, max electrical power 11 W, standard energy saving type lamp
caractéristiques de l'ampoule: culot E27, tension max 220, puissance max 11W, type économie d'énergie standard
charakteristik der Lampe E27 Fassung, max. 220 Volt max. 11 W. Energiesparlampe Typ Standard

codice senza colore code without colour	Cm	dimensioni dimensions			litri liters	Confezione minima Minimum package	m ³	pezzi pallet pcs pallet	m ³	accessori accessories
13 432 050	50	a34	b50	c22	10	1 34x34x50h	0,06	16 80x120x112h	1,10	
13 432 070	70	a42	b70	c28	17	1 42x42x70h	0,10	18 80x120x226h	2,20	
13 432 090	90	a52	b90	c30	29	1 52x52x90h	0,20	8 100x120x195h	2,30	

Fix Ground
Fix Wall
pagina 226

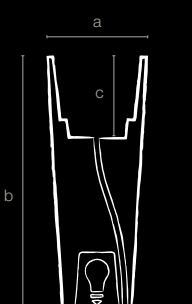

caratteristiche lampada: attacco E27, tensione max 220, potenza max 11 W, tipo risp. energ. standard
lamp characteristics: electrical coupling E27, max voltage 220, max electrical power 11 W, standard energy saving type lamp
caractéristiques de l'ampoule: culot E27, tension max 220, puissance max 11W, type économie d'énergie standard
charakteristik der Lampe E27 Fassung, max. 220 Volt max. 11 W. Energiesparlampe Typ Standard

codice senza colore code without colour	Cm	dimensioni dimensions			litri liters	Confezione minima Minimum package	m ³	pezzi pallet pcs pallet	m ³	accessori accessories
13 462 070	70	a40	b68	c25	31	1 40x40x70h	0,10	24 80x120x210h	2,00	
13 462 100	100	a40	b100	c39	32	1 40x40x100h	0,10	12 80x120x212h	2,00	

Fix Ground
Fix Wall
pagina 226





Superficie opaca
Matt finished
Surface opaque
Matt-Oberfläche



Bassano outdoor

caratteristiche lampada: attacco E27, tensione max 220, potenza max 11 W, tipo risp. energ. standard



lamp characteristics: electrical coupling E27, max voltage 220, max electrical power 11 W, standard energy saving type lamp

caractéristiques de l'ampoule: culot E27, tension max 220, puissance max 11W, type économie d'énergie standard

charakteristik der Lampe E27 Fassung, max. 220 Volt max. 11 W. Energiesparlampe Typ Standard

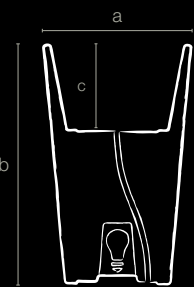

UV-RESISTANT



-10 +50



codice senza colore code without colour	Cm	dimensioni dimensions	litri liters	Confezione minima Minimum package	m ³	pezzi pallet pcs pallet	m ³	accessori accessories
13 423 060 033	60	a45 b60 c20	17	1 45x45x60h	0,10	12 80x120x200h	2,40	
13 423 100 033	100	a60 b100 c39	48	1 60x60x100h	0,30	4 80x120x220h	2,10	

Fix Ground
Fix Wall
pagina 226



Superficie opaca
Matt finished
Surface opaque
Matt-Oberfläche



Schio cassa alta outdoor

caratteristiche lampada: attacco E27, tensione max 220, potenza max 11 W, tipo risp. energ. standard



lamp characteristics: electrical coupling E27, max voltage 220, max electrical power 11 W, standard energy saving type lamp

caractéristiques de l'ampoule: culot E27, tension max 220, puissance max 11W, type économie d'énergie standard

charakteristik der Lampe E27 Fassung, max. 220 Volt max. 11 W. Energiesparlampe Typ Standard

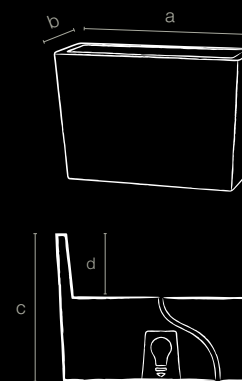

codice senza colore code without colour	Cm	dimensioni dimensions	litri liters	Confezione minima Minimum package	m ³	pezzi pallet pcs pallet	m ³
13 428 050 033	50	a50 b36 c70 d29	31	1 50x36x70h	0,10	12 80x120x222h	2,10
13 428 100 033	100	a100 b36 c70 d29	70	1 100x36x70h	0,20	6 80x120x222h	2,10



UV-RESISTANT



-10 +50





Superficie opaca
Matt finished
Surface opaque
Matt-Oberfläche



Schio cubo alto outdoor

caratteristiche lampada: attacco E27, tensione max 220, potenza max 11 W, tipo risp. energ. standard
lamp characteristics: electrical coupling E27, max voltage 220, max electrical power 11 W, standard energy saving type lamp
caractéristiques de l'ampoule: culot E27, tension max 220, puissance max 11W, type économie d'énergie standard
charakteristik der Lampe E27 Fassung, max. 220 Volt max. 11 W. Energiesparlampe Typ Standard



Superficie opaca
Matt finished
Surface opaque
Matt-Oberfläche



Schio cono outdoor

caratteristiche lampada: attacco E27, tensione max 220, potenza max 11 W, tipo risp. energ. standard
lamp characteristics: electrical coupling E27, max voltage 220, max electrical power 11 W, standard energy saving type lamp
caractéristiques de l'ampoule: culot E27, tension max 220, puissance max 11W, type économie d'énergie standard
charakteristik der Lampe E27 Fassung, max. 220 Volt max. 11 W. Energiesparlampe Typ Standard

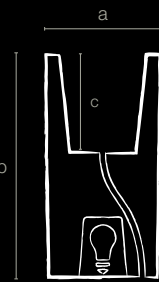
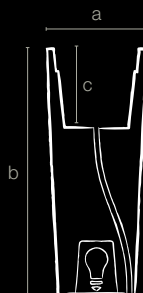

codice senza colore code without colour	Cm	dimensioni dimensions	litri liters	Confezione minima Minimum package	m ³	pezzi pallet pcs pallet	m ³	accessori accessories
13 426 080	033	80	a40 b80 c34,5	31	1	40x40x80h	0,10	15 80x120x212h 2,00

Fix Wall
pagina 227

codice senza colore code without colour	Cm	dimensioni dimensions	litri liters	Confezione minima Minimum package	m ³	pezzi pallet pcs pallet	m ³	accessori accessories
13 424 070	033	70	a30 b68 c20	8	1	30x30x68h	0,06	24 80x120x225h 2,10
13 424 090	033	90	a40 b90 c35	26	1	40x40x90h	0,10	12 80x120x195h 1,80
13 424 110	033	110	a45 b110 c35	35	1	45x45x110h	0,20	12 80x120x236h 2,20
13 424 145	033	145	a55 b145 c31	46	1	55x55x145h	0,40	4 100x120x160h 1,90

Fix Ground
Fix Wall
pagina 226





Superficie opaca
Matt finished
Surface opaque
Matt-Oberfläche

A-malo luce outdoor

- 
- 
- 
- 
- 
- 
- 



codice senza colore code without colour	Cm	dimensioni dimensions	Confezione minima Minimum package
13 452 150 anello luce	043 037 150	a 150	1 150x150x8h 0,18
13 452 220 anello luce	043 037 220	a 220	1 158x158x120h 2,99

Per installazione all'esterno. Certificati CE, classe di isolamento IP55, completi di cavo di alimentazione, presa bipolare, lampada. Non sono dotati di interruttore. Si consiglia che l'installazione all'esterno venga effettuata da personale qualificato. Le versioni outdoor sono dotate di un foro e un tubo per il drenaggio dell'acqua che si potrà accumulare nel contenitore. È fondamentale che il foro e il tubo non vengano ostruiti in modo tale da permettere un sicuro drenaggio. Per questo consigliamo di non mettere mai la pianta o la terra direttamente nel contenitore ma di posizionare sempre un sottovaso e un vaso di contenimento di dimensioni appropriate. Pulire frequentemente il foro e il tubo di drenaggio.

For outdoor installation. Certificates CE, IP55 dielectric strength class, complete with power cord, hole plug, lamp. Not equipped with a switch. It is recommended that the installation is made by qualified personnel. The outdoor version is equipped with a hole and a tube to drain water that might be accumulated in the container. It is important that the hole and the tube will not be obstructed

so as to allow safe drainage. Therefore we recommend to never put the plant or the soil directly in the container but always place a saucer and a pot of appropriate sizes. Never put the soil or plant directly into the container. In this way you risk to obstruct the hole and the drainage tube compromising their operation and safety. Please clean frequently the hole and the drainage tube.

Ne jamais mettre la terre ou la plante directement dans le recipient. De cette manière il peut s'obstruer l'orifice et le tuyau de drainage en compromettant le fonctionnement et la sûreté. Mettre toujours un sous-vase ou un vase de la dimension appropriées à la plante. Nettoyer souvent le trou et le tube de drainage.

fonctionnement et la sûreté. Mettre toujours un sous-vase ou un vase de la dimension appropriées à la plante. Nettoyer souvent le trou et le tube de drainage.

Niemals Erde oder Pflanzen direkt in den Behälter setzen. Sie riskieren, dass Öffnung und Rohr der Drainage verstopfen und somit die Funktion und Sicherheit nicht gewährleistet ist. Benutzen Sie stets Pflanztopfuntersetzer oder Töpfe mit angepasster Größe für Behälter und Pflanze. Reinigen Sie regelmäßig Öffnung und Rohr der Drainage. Sie riskieren, dass Öffnung und Rohr der Drainage verstopfen und somit die Funktion und Sicherheit nicht gewährleistet ist. Reinigen Sie regelmäßig Öffnung und Rohr der Drainage.

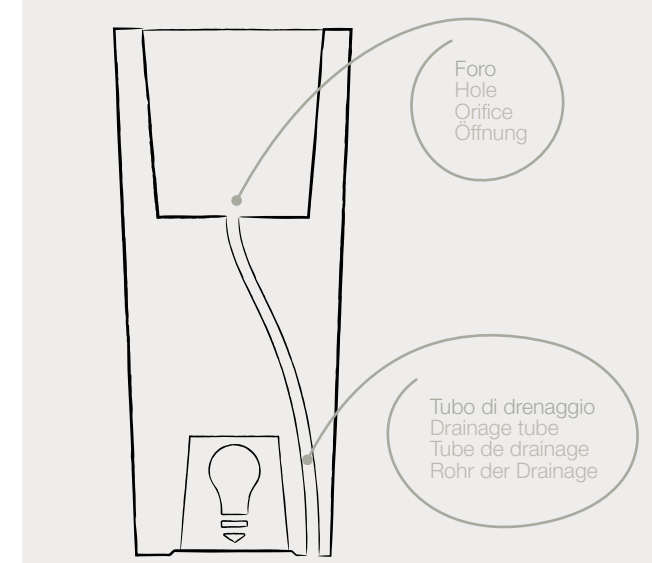

Luce inclusa White cold lamp Ampoule à blanche Lampe weiss



Per tutti gli articoli della linea Luce è possibile acquistare come supplemento la lampadina LED, disponibile in due versioni:

For all items of the collection Luce it is possible to buy an additional LED lamp, of which two options are available:

Pour tous les articles de la ligne Luce il est possible d'acheter à part l'ampoule led disponible en deux versions:

Für alle Artikel der Linie Luce besteht die Möglichkeit die LED Lampen in zwei Versionen zu erwerben:

Luce led bianca optional Additional led lamp Ampoule à leds supplémentaire Zusatz led Lampe



codice senza colore code without colour	Confezione minima Minimum package
10 906 000	1 



Luce led multicolor con telecomando optional
Multicoloured led lamp with remote control
Ampoule à leds à couleurs changeantes avec télécommande
Lampe led multicolor mit Fernbedienung

codice senza colore code without colour	Confezione minima Minimum package
10 907 000	1 

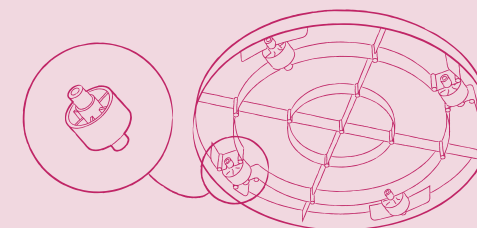

Mover è dotato di ruote bidirezionali ad incastro.
 Mover has got bidirectional wheels.
 Le Mover a les roues bidirectionnels.
 Der Mover hat bidirektionale Räder.

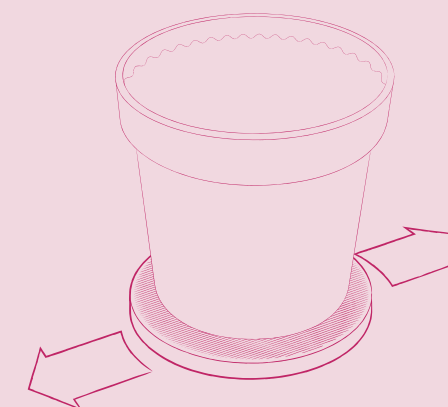

005
 antracite/anthracite
 anthracite/anthrazitgrau

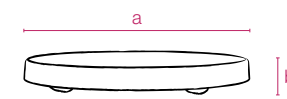

codice senza colore code without colour	Cm	dimensioni dimensions	Confezione minima Minimum package	m ³	pezzi pallet pcs pallet	m ³
10 121 029	29	a29 b2,6	30 58X29X41h	0,07	240 80x120x100h	1,15
10 121 034	34	a34 b2,6	15 34X34X41h	0,05	180 80x120x100h	1,15
10 121 039	39	a39 b2,6	14 39X39X41h	0,06	180 80x120x100h	1,15



Superficie opaca
 Matt finished
 Surface opaque
 Matt-Oberfläche



Mover

Fix Ground round



ACCESSORI: articoli molto semplici ma di sicuro utilizzo. Fissati a una parete o sul pavimento riducono notevolmente le possibilità di ribaltamento accidentale.

ACCESSORIES: items very simple but certainly used. Attached to a wall or lying on the floor they reduced significantly the possibility of rollover accident.

ACCESSOIRES: des articles très simples mais sûrement utiles. Fixés au mur ou au plancher, ils réduisent considérablement le risque de renversement accidentel.

ZUBEHÖR: diese Artikel sind sehr einfach aber ganz sicherlich nützlich. Festgeschraubt auf einer Wand oder auf dem Boden, reduzieren sie stark das Umkippenrisiko.

codice senza colore code without colour	Cm	dimensioni dimensions	Confezione minima Minimum package	m ³
10 903 041	41	a41 b0,5	2 42x42x4h	0,01
10 903 048	48	a48 b0,5	2 50x50x4h	0,01
10 903 060	60	a60 b0,5	2 62x62x4h	0,01

Fix Ground square

codice senza colore code without colour	Cm	dimensioni dimensions	Confezione minima Minimum package	m ³
10 908 039	39	a39 b0,5	2 40x40x4h	0,01

Fix Wall

codice senza colore code without colour	Cm	dimensioni dimensions	Confezione minima Minimum package	m ³
10 904 007	7	a21 b0,5	2 25x15x5h	0,002



Rotelle standard S3-3

codice senza colore code without colour	Confezione minima Minimum package	m ³
10 902 004	4x12 15x15x10h	0,002



Colori on Demand

Colours on Demand

Farben auf Anfrage

Couleurs sur Demande

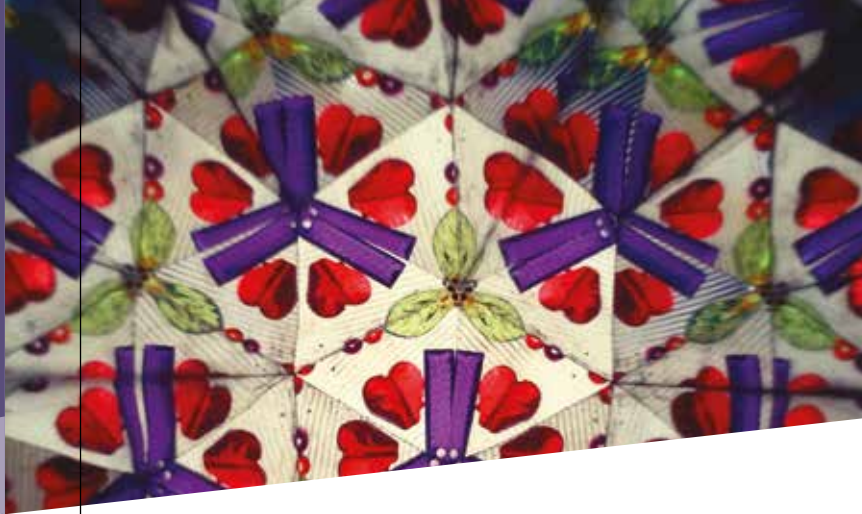

024	trasparente / transparent
022	bianco / white
012	argento / silver
008	sabbia / sand colour
013	giallo / yellow
419	giallo / yellow
011	oro / gold
016	arancio / orange
010	rosso / red
014	rosso intenso / intense red
416	marsala / marsala
020	bronzo / bronze
018	ciclaminio / cyclamen
401	peonia / peony
019	lilla / lilac
402	lilyum / lilyum
009	viola / violet
405	bambù / bamboo
404	cedro / cedar
007	verde / green
407	salvia / sage
002	verde / green
028	turchese / turquoise
015	azzurro / light blue
017	blu / blue
403	corda / cord
417	aluminium / aluminium
406	bruno / brown
415	terra di Siena / terra di siena
408	cacao / cacao
001	terraccotta / terracotta colour

414	fog grey / fog grey
005	brouillard gris / Nebel grau
006	anthracite / anthracite
003	nero / black
412	acqua marina / aquamarine
410	ghiaccio / ice
409	malva / mauve
411	porcellana / porcelain
043	bianco / white
033	bianco neutro / neutral white
071	bianco lucido / gloss white
034	arancio / orange
030	anticato / light brown
048	rosso / red
050	rosso cardinale / cardinal red
070	rosso lucido / gloss red
042	fucsia / fuchsia
231	fucsia / fuchsia
068	fucsia / fuchsia
211	melanzana / aubergine
234	malva / mauve
202	lavanda / lavender
203	lime / lime
232	kiwi / kiwi
208	menta / mint
041	verde mela / green apple
230	cielo / sky blue
204	grigio seta / silk grey
201	capuccino / cappuccino
233	toffee / toffee
049	grigio fumo / smoke grey
039	bronzo / bronze
210	grafite / graphite
235	beton / beton
032	anthracite / anthracite
037	nero / black
072	nero lucido / gloss black

INIEZIONE

ROTAZIONALE

INIEZIONE

- Linea Elements
- Linea Clear
- Linea Pastel
- Linea Colour
- Linea Basic
- T-basket
- Linea Flortec

ROTAZIONALE

- Linea Essential
- Self Watering
- Linea Classic
- Linea City
- Linea Luce

Colori on Demand
da concordare con la rete vendita
minimi d'ordine e quantità.

Colours on Demand to be agreed
with the Sales network, minimum
order quantity and prices.

Farben auf Anfrage. Mindestbe-
stellmenge und Preise müssen mit
den Vertretern vereinbart werden.

Couleurs sur demande à définir
avec le réseau commercial, mini-
mum commande et prix.

Progetto grafico ed impaginazione:

Verde Pistacchio - info@verdepistacchio.net

Le ambientazioni:

Alexis visual arts - Via Giovanni Dolfin, 8 - 36016 Thiene (VI) - www.alexisvisual.com per pag. 41.

Verde Architettura - via Fumagalli, 7 - 20143 (MI) - www.verdearchitettura.it per pag. 218.

Anymotion - Corso Garibaldi, 81 - 29017 Fiorenzuola D'Arda (PC) pag. 214, 215, 216, 219.

Foto:

Photopiù - Via Rivarotta, 165 - 36061 Bassano del Grappa (VI) - www.photopiu.it

Designer:

favarettoandpartner di pag. 40.

Irina Alekseeva di pag. 206, 207, 208.

Dati, foto e caratteristiche non sono impegnativi; Teraplast si riserva di apportare le modifiche che riterrà opportune per migliorare i suoi prodotti.
Tutte le parti di questo catalogo - foto comprese - sono di proprietà di Teraplast. La riproduzione, anche parziale, è vietata in ogni forma e con ogni mezzo.

Data, photos, and characteristics are not binding; Teraplast reserves the right to produce modifications considered necessary to improve its products.
Every part of this catalogue - photos included - is the property of Teraplast. All forms of copying are strictly prohibited.

MADE IN ITALY

TeraPlast
italian beauty

Terra Group
Wrocławska 17B
65-427 Zielona Góra
PL 928 000 48 01

T. +48 68 455 62 69
F. +48 68 359 41 52
info@terra-pl.eu
www.terra-pl.eu

WYŁĄCZNY DYSTRYBUTOR TERAPLAST NA POLSKĘ