



MODULAR URBAN BENCHES

COMPATIBLE WITH XXL POTS



## MODULAR URBAN BENCHES

COMPATIBLE WITH XXL POTS

[www.terracity.eu](http://www.terracity.eu)

COLLECTION  
OF URBAN BENCHES

## ZEBRA

4 - 23

Round Bench Zebra 80 / Zebra 95 / Zebra 120

6 - 11

Round Bench ½ Zebra 80 / ½ Zebra 95 / ½ Zebra 120

12 - 17

Oblong Bench Zebra Basic and Zebra

18 - 23

## WAVE

24 - 39

Solo Set for Gianto

28

Doble Set for Gianto

29

Triple Set for Gianto

30

Tri Set for Gianto

31

Quintus Set for Gianto

32

Elements for Sets

33





Zebra 80 & Gianto 80 pot, Zebra 95 & Gianto 95 pot, Zebra 120 & Gianto 120 pot

# ZEBRA

---

## Nature all around

Relax in the city center and in the surroundings of plants – it is possible thanks to the furniture from the Zebra Collection. A characteristic feature of the line are round benches, which go together with Gianto pots. An additional advantage is fabulously colorful finish. It is essential that the seat may have various color options - each rung can go in any version and their final image is not limited in any way. This can be a great idea for an arrangement of school... playgrounds, parks or estate squares. The polyethylene pot and steel seat assure that their form will remain unchanged for years as well as their resistance to the various weather conditions and mechanical damage.

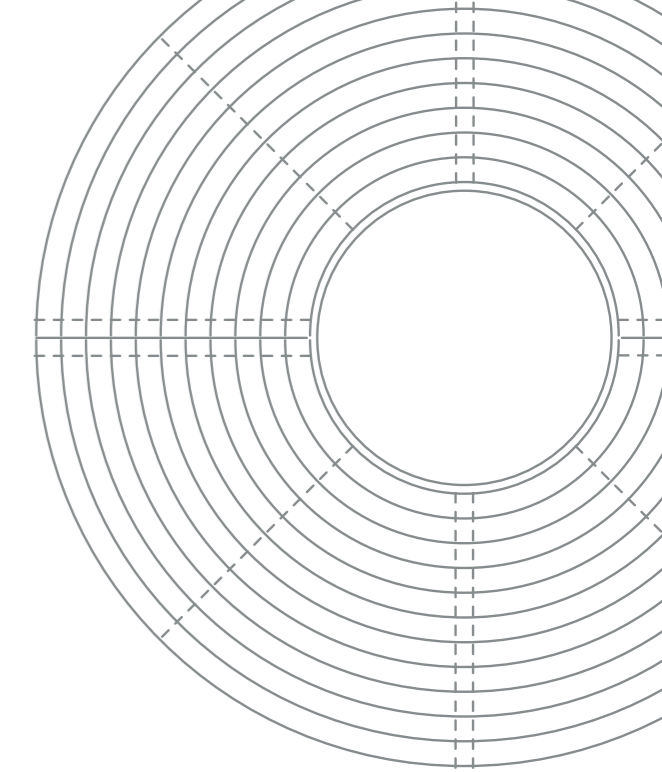



## ROUND BENCHES

Zebra 80 / Zebra 95 / Zebra 120

A round bench, compatible with Gianto, with a half-round shape guarantees an eye-catching visual effect but also comfort of use. A steel bench and polyethylene used in the production process assure resistance, regardless of the weather conditions. The colors of each bench rung can be chosen according to your needs.



**Zebra 80**

A round bench compatible with Gianto 80



**Zebra 95**

A round bench compatible with Gianto 95

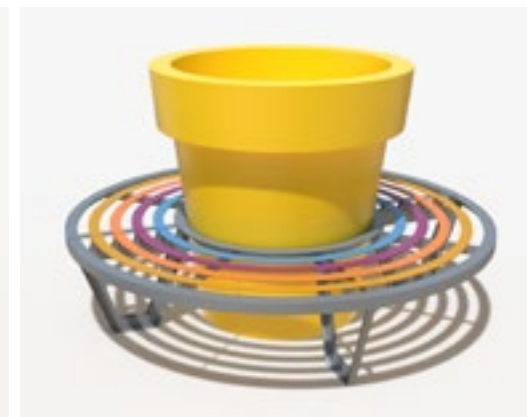
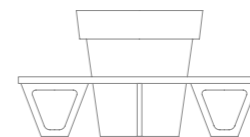

**Zebra 120**

A round bench compatible with Gianto 120

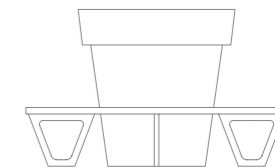





## FEATURES



a wide range of colors



powder coating RAL



hot-dip galvanized steel



compatible with the Gianto pot



smooth or rough surface



fixings to the ground

- Choose rung colors of the bench according to your needs from our RAL palette
- Fixing to the ground (optional)
- Compatible pot- Gianto

## COLORS

ARE YOU LOOKING FOR A PRODUCT IN A DIFFERENT COLOR? ●  
Ask your sales advisor about the details.

Antique colors



RAL colors



Model	Code	Dimensions [mm]	Compatibility	Net Price
Zebra G80/1700 Multicolor*	TC 002 401	Ø 1720 × h 450 × d 550	Gianto 80	1 000 €
Zebra G80/1700 Monocolor**	TC 002 401...	Ø 1720 × h 450 × d 550	Gianto 80	880 €
Zebra G95/1800 Multicolor*	TC 002 402	Ø 1820 × h 450 × d 550	Gianto 95	1 250 €
Zebra G95/1800 Monocolor**	TC 002 402...	Ø 1820 × h 450 × d 550	Gianto 95	1 025 €
Zebra G95/1900 Multicolor*	TC 002 403	Ø 1900 × h 450 × d 550	Gianto 95	1 250 €
Zebra G95/1900 Monocolor**	TC 002 403...	Ø 1900 × h 450 × d 550	Gianto 95	1 025 €
Zebra G120/2000 Multicolor*	TC 002 404	Ø 2000 × h 450 × d 550	Gianto 120	1 350 €
Zebra G120/2000 Monocolor**	TC 002 404...	Ø 2000 × h 450 × d 550	Gianto 120	1 100 €

● \*Multicolor - A ready set of antique colors or RAL colors

● \*\*Monocolor - One selected antique color or RAL color





Zebra 120 & Gianto 120 pot





## SEMI-ROUND BENCHES

½ Zebra 80 / ½ Zebra 95 / ½ Zebra 120

This city bench in a semicircular shape, compatible with Gianto & Extravase ½, guarantees attractive visual effect and comfort of use. A steel bench and polyethylene used in the production process of the pot assure resistance, regardless of the weather conditions. Each bench rung can have any color.



**½ Zebra 80**

Semi-round bench compatible with Extravase ½ 60

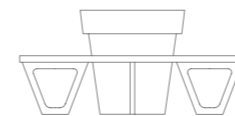

**½ Zebra 95**

Semi-round bench compatible with Extravase ½ 80

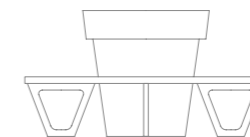

**½ Zebra 120**

Semi-round bench compatible with Extravase ½ 100

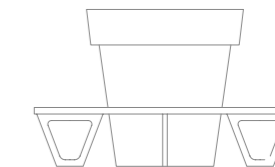



## FEATURES



a wide range of colors



powder coating RAL



hot-dip galvanized steel



compatible with the Gianto pot



smooth or rough surface



fixings to the ground

- Choose rung colors of the bench according to your needs from our RAL palette
- Fixing to the ground (optional)
- Compatible pot - Extravase 1/2 to be set against the wall

## COLORS

ARE YOU LOOKING FOR A PRODUCT IN A DIFFERENT COLOR? ●  
Ask your sales advisor about the details.

Antique colors



RAL colors



Model	Code	Dimensions [mm]	Compatibility	Net Price
1/2 Zebra G80/1700 Multicolor*	TC 002 304	Ø 1720 × r 860 × h 450 × d 550	Extravase 1/2 60	650 €
1/2 Zebra G80/1700 Monocolor**	TC 002 304...	Ø 1720 × r 860 × h 450 × d 550	Extravase 1/2 60	550 €
1/2 Zebra G95/1800 Multicolor*	TC 002 303	Ø 1820 × r 910 × h 450 × d 550	Extravase 1/2 80	750 €
1/2 Zebra G95/1800 Monocolor**	TC 002 303...	Ø 1820 × r 910 × h 450 × d 550	Extravase 1/2 80	650 €
1/2 Zebra G95/1900 Multicolor*	TC 002 305	Ø 1900 × r 950 × h 450 × d 550	Extravase 1/2 80	750 €
1/2 Zebra G95/1900 Monocolor**	TC 002 305...	Ø 1900 × r 950 × h 450 × d 550	Extravase 1/2 80	650 €
1/2 Zebra G120/2000 Multicolor*	TC 002 308	Ø 2000 × r 1000 × h 450 × d 550	Extravase 1/2 100	800 €
1/2 Zebra G120/2000 Monocolor**	TC 002 308...	Ø 2000 × r 1000 × h 450 × d 550	Extravase 1/2 100	650 €

● \*Multicolor - A ready set of antique colors or RAL colors

● \*\*Monocolor - One selected antique color or RAL color









## OBLONG BENCHES

with or without a backrest

The city bench has a unique shape and color. Steel surface guarantees durability and resistance of the bench, regardless of the weather conditions. The bench is fixed with anchors, assuring resistance to mechanical damage. Each bench rung can have any color.



### Zebra Basic Horizontal

An extraordinary city bench with a horizontal set of rungs



### Zebra Basic Vertical

An extraordinary city bench with a vertical set of rungs



### Zebra

An ergonomic city bench with a backrest





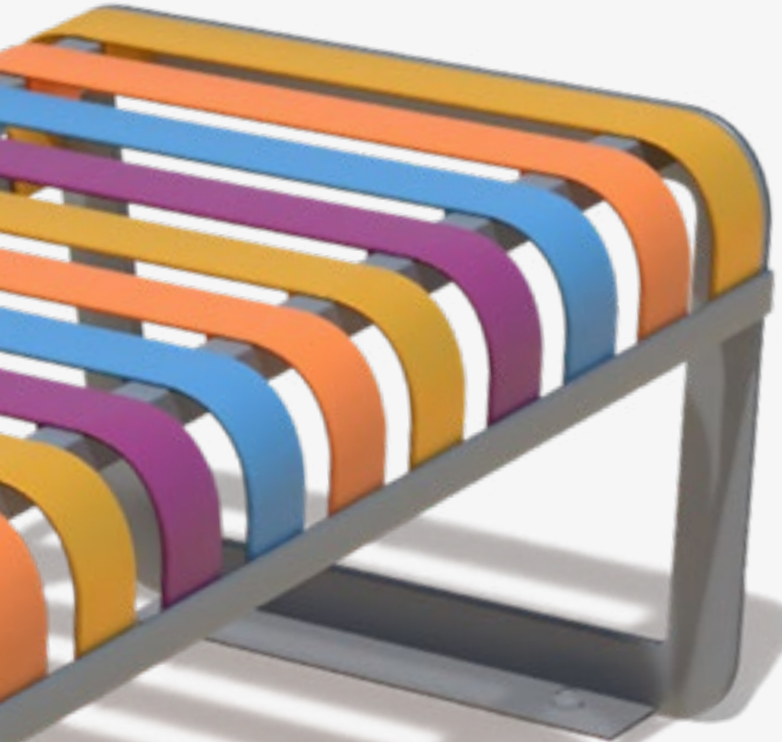

## FEATURES



a wide range of colors



powder coating RAL



hot-dip galvanized steel



smooth or rough surface



fixings to the ground

- Choose rung colors of the bench according to your needs from our RAL palette
- Fixing to the ground (optional)
- Vertical (transverse) or horizontal (longitudinal) rung distribution - applies to benches without backrests
- Ergonomic shape of the seat

## COLORS

ARE YOU LOOKING FOR A PRODUCT IN A DIFFERENT COLOR? ●  
Ask your sales advisor about the details.

Antique colors



RAL colors



Model	Code	Dimensions [mm]	Net Price
Zebra Basic Multicolor* Vertical	TC 002 306	w 1650 × h 440 × ds 580	650 €
Zebra Basic Monocolor** Vertical	TC 002 306...	w 1650 × h 440 × ds 580	550 €
Zebra Basic Multicolor* Horizontal	TC 002 309	w 1650 × h 440 × ds 580	550 €
Zebra Basic Monocolor** Horizontal	TC 002 309...	w 1650 × h 440 × ds 580	450 €
Zebra Multicolor*	TC 002 307	w 1650 × d 700 × h 900 × ds 440 × hs 440	700 €
Zebra Monocolor**	TC 002 307...	w 1650 × d 700 × h 900 × ds 440 × hs 440	550 €

● \*Multicolor - A ready set of antique colors or RAL colors

● \*\*Monocolor - One selected antique color or RAL color









Triple Set for Gianto & Gianto 80 i 95 pots

# WAVE

## Nature and functionality

Nature and functionality – these are the elements from which the collection of urban furniture WAVE arouse from. A consistent effect assure the Gianto pot, with its classical form and vivid colors, as well as unique seats with their colorful finish. The WAVE collection has a number of advantages – any combination of colors, container sizes and bench sizes allow to adapt the furniture to any space: from the main square to the kindergarten playground. A simple combination of each seat module provides next options of arrangement. Solid steel and resistant polyethylene guarantee the use for many years without any problems.

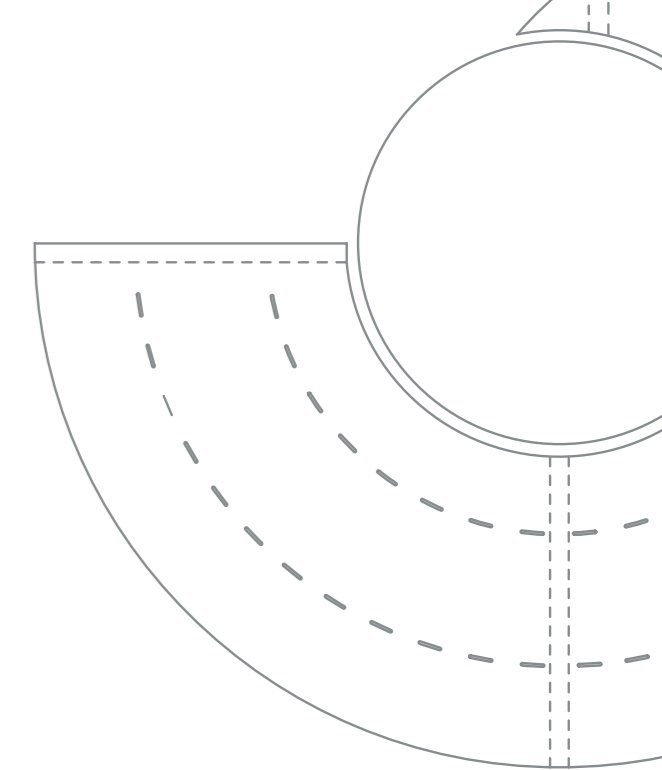





## BENCHES WAVE

Solo, Doble, Triple, Tri, Quintus

The color, attractive form, piece of nature and comfortable seat - these are the elements, which are the most significant advantages of benches from the Wave line. This innovative project is a response to modern space requirements, which is not only a piece of furniture but also a made-to-measure decorative element. A free module combination allows to create arrangements of different colors and sizes. Create some unique composition!



Triple Set for Gianto & Gianto 80 i 95 pots



## Solo Set for Gianto

A set of two elements:  
Half Bench & Left-Handed Pointed Bench

Compatible with pot:  
Gianto 80,95 and 120

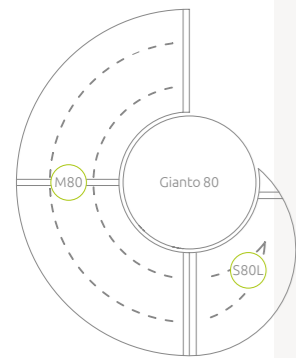

## Doble Set for Gianto

A set of four elements:  
2 x Half Bench & 2 x Left-Handed Pointed Bench

Compatible with pot:  
Gianto 80,95 and 120

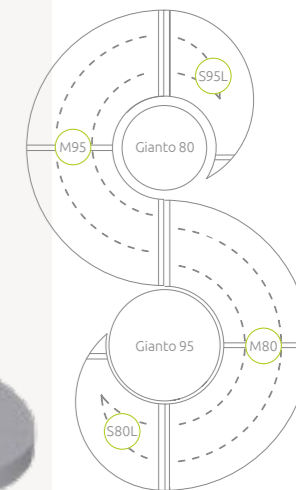



## Triple Set for Gianto

A set of five elements:

3x Half Bench & & Left and Right-Handed Pointed Bench

Compatible with pot:

Gianto 80,95 and 120

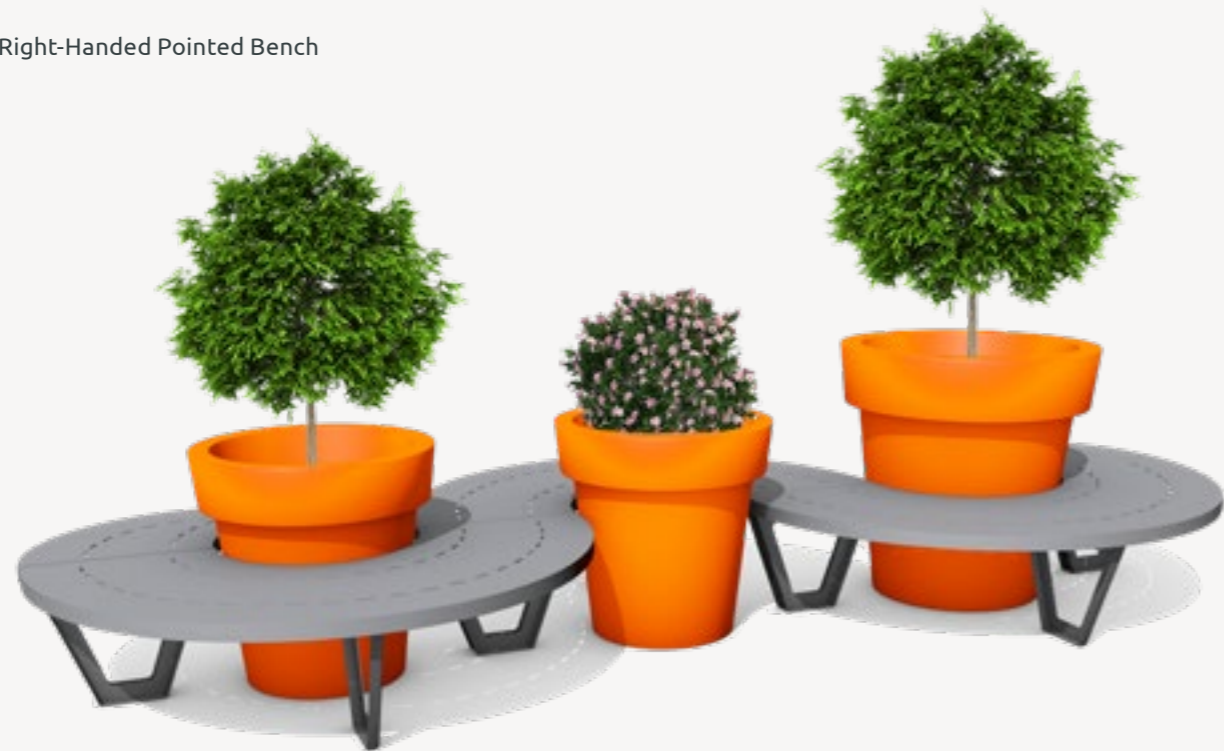
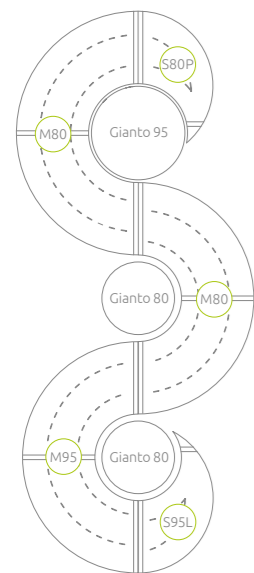

## Tri Set for Gianto

A set of five elements:

1x Half Bench & 2x Quarter Bench  
& & Left and Right-Handed Pointed Bench

Compatible with pot:

Gianto 80,95 and 120

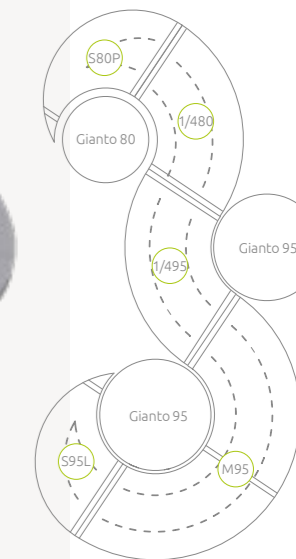



## Quintus Set for Gianto

A set of five elements:

1x Half Bench & 4x Quarter Bench

& Left and Right-Handed Pointed Bench

Compatible with pot:

Gianto 80,95 and 120

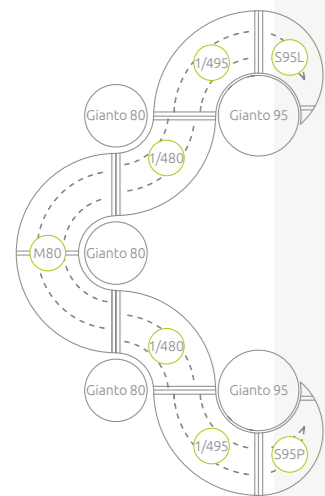

## COMBINE ANY ELEMENTS

-CREATE WAVE SETS

elements for Wave sets



Quarter Bench for Gianto

Element of the bench  
in the shape of a 1/4 circle

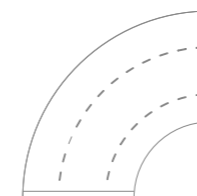

Half Bench for Gianto

Half-rounded element  
- a central part of the bench

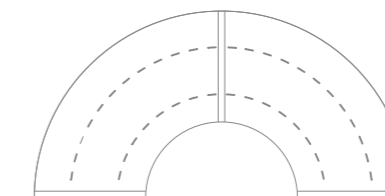

Pointed Bench for Gianto

Element for aesthetic  
finishing the bench

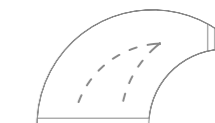





## COLORS



Antique colors

ARE YOU LOOKING FOR A PRODUCT IN A DIFFERENT COLOR?  
Ask your sales advisor about the details.

## FEATURES



compatible with the whole collection



powder coating RAL



hot-dip galvanized steel



a seat covered with zinc undercoat



compatible with the Gianto pot



fixings to the ground

- Any combination of elements - personalized Wave sets
- Compatible pot- Gianto
- Fixing to the ground (optional)

Model	Code	Dimensions [mm]	Compatibility	Net Price
1/4 80	TC 003 401	h 450 × d 555 × w 870	Gianto 80	263 €
1/4 95	TC 003 402	h 450 × d 555 × w 935	Gianto 95	288 €
1/4 120	TC 003 403	h 450 × d 555 × w 1000	Gianto 120	438 €
M80	TC 003 302	Ø 1740 × r 870 × h 450 × d 555	Gianto 80	485 €
M95	TC 003 301	Ø 1870 × r 935 × h 450 × d 555	Gianto 95	530 €
M120	TC 003 303	Ø 2000 × r 1000 × h 450 × d 555	Gianto 120	788 €
Pointed Bench Right-Handed S80P	TC 003 703	w 980 × y 555 × h 450 × d 555	Gianto 80	175 €
Pointed Bench Left-Handed S80L	TC 003 704	w 980 × y 555 × h 450 × d 555	Gianto 80	175 €
Pointed Bench Right-Handed S95P	TC 003 701	w 1010 × y 575 × h 450 × d 555	Gianto 95	195 €
Pointed Bench Left-Handed S95L	TC 003 702	w 1010 × y 575 × h 450 × d 555	Gianto 95	195 €
Pointed Bench Right-Handed S120P	TC 003 705	w 1225 × y 730 × h 450 × d 555	Gianto 120	238 €
Pointed Bench Left-Handed S120L	TC 003 706	w 1225 × y 730 × h 450 × d 555	Gianto 120	238 €
Solo Set (S80L + M80)	TC 003 801	Ø 1740 × w 1425 × h 450	Gianto 80	660 €
Solo Set (S95L + M95)	TC 003 802	Ø 1870 × w 1510 × h 450	Gianto 95	725 €
Solo Set (S120L + M120)	TC 003 808	Ø 2000 × w 1730 × h 450	Gianto 120	1 025 €
Doble Set (S95L + M95 + M80 + S80L)	TC 003 803	w 1805 × l 3055	Gianto 80, 95	1 385 €
Triple Set (S95L + M95 + M80 + M95 + S95P)	TC 003 804	w 1805 × l 4370	Gianto 80, 95	1 935 €
Triple Set (S95L + M95 + M80 + M80 + S80P)	TC 003 805	w 1805 × l 4240	Gianto 80, 95	1 870 €
Tri Set (S95L + M95 + 1/4 95 + 1/4 80 + S80P)	TC 003 806	w 3120 × l 2760	Gianto 80, 95	1 450 €
Quintus Set (S95L + 1/4 95 + 1/4 80 + M80 + 1/4 80 + 1/4 95 + S95P)	TC 003 807	w 4300 × l 2760	Gianto 80, 95	1 975 €





Triple Set for Gianto & Gianto 80, 95 pots



Doble Set for Gianto & Gianto 80, 95 pots





Doble Set for Gianto & Gianto 80, 95 pots



Triple Set for Gianto & Gianto 80, 95 pots





*TerraCity - a brand of Terra Group*

**Terra Group**  
*create more  
beautiful tomorrow!*

ul. Gen. Józefa Sowińskiego 42a  
65-419 Zielona Góra

T: +48 68 455 62 69  
F.: +48 68 414 54 25

E: [info@terra-uk.eu](mailto:info@terra-uk.eu)  
[www.terra-uk.eu](http://www.terra-uk.eu)