



URBAN FURNITURE COLLECTION



www.terracity.eu

COLLECTIONS

ZEBRA

4

Round Bench Zebra 95	6
Round Bench Zebra 95 1/2	8
Round Bench Zebra 120	10
Round Bench Zebra 120 1/2	12
Bench with backrest Zebra	18
Bench without backrest urbana Zebra Basic	20

WAVE

24

Quarter Bench For Gianto	26
Half Bench For Gianto	28
Pointed Bench For Gianto	30
Solo Set For Gianto	32
Doble Set For Gianto	34
Triple Set For Gianto	36
Tri Set For Gianto	38
Quintus Set For Gianto	40

URBANA

46

Urban Pot Urbana L	48
Urban Pot Urbana XL	50
Bicycle Rank Urbana L	52
Bicycle Rank Urbana XL	54
Tourist Information Stand Urbana L	56
Tourist Information Stand Urbana XL	58
Urban Pot Urbana ¼	62
Urban Bench Urbana L	64
Urban Bench Urbana XL	66
Railing Urbana L	68
Railing Urbana XL	70

ZEBRA

Nature all around

Relax in the city center and in the surroundings of plants – it is possible thanks to the furniture from the Zebra Collection. A characteristic feature of the line are round benches, which go together with Gianto pots. An additional advantage is fabulously colorful finish. It is essential that the seat may have various color options - each rung can go in any version and their final image is not limited in any way. This can be a great idea for the arrangement of the school playgrounds, parks or estate squares. The polyethylene pot and steel seat assure that their form will remain unchanged for years as well as their resistance to the various weather conditions and mechanical damage.



Round Bench Zebra 95

This city bench, compatible with Gianto 95, in a circular and semicircular shape, guarantees not only comfort of use but also an attractive visual effect. Solid materials used in the production process of the bench guarantee durability and reliability of the construction for long years, even in unfavorable weather conditions. Each bench rung can have any color.

Features



a wide range of colors



powder coating RAL



hot-dip galvanized steel



compatible with the Gianto pot



smooth or rough surface



fixings to the ground



Waranty 24 months

Model	Code	Dimensions [mm]	Compatibility
Zebra G95/1800 Multicolor*	TC 002 402	Ø 1820 × h 450 × d 550	Gianto 95
Zebra G95/1800 Monocolor**	TC 002 402...	Ø 1820 × h 450 × d 550	Gianto 95
Zebra G95/1900 Multicolor*	TC 002 403	Ø 1900 × h 450 × d 550	Gianto 95
Zebra G95/1900 Monocolor**	TC 002 403...	Ø 1900 × h 450 × d 550	Gianto 95

● *Multicolor - A ready set of antique colors or RAL colors

● **Monocolor - One selected antique color or RAL color



1 - green



2 - gold



3 - copper



4 - black



RAL 7001*



RAL 1004



RAL 2000



RAL 4006



RAL 5012



RAL 7001*



RAL 9016



RAL 6034



RAL 5008



RAL 1015

antique colors

RAL vivid colours

RAL fading colours

ARE YOU LOOKING FOR A PRODUCT IN A DIFFERENT COLOR? Ask your sales advisor about the details.

*RAL 7001 - the constant colour of the rack with supporting feet and the first ring

Zebra G95/1800 Multicolor

Ø 1820 × h 450 × d 550 mm

Choose rung colors of the bench according to your needs from the RAL palette

Compatible pot- Gianto 95

Fixing to the ground (optional)



front view



sketch

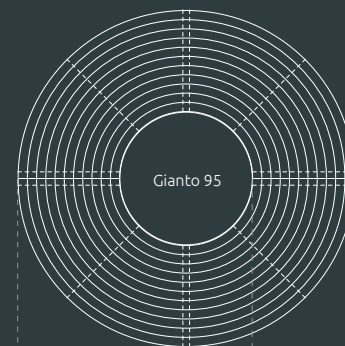

side view



Option available: G95/1900 means a wider diameter of the bench

Round Bench Zebra 95 1/2

This city bench, compatible with Extravase 1/2 80, in a circular and semicircular shape, guarantees not only comfort of use but also an attractive visual effect. Solid materials used in the production process of the bench guarantee durability and reliability of the construction for long years, even in unfavorable weather conditions. Each bench rung can have any color.

Features



a wide range of colors



powder coating RAL



hot-dip galvanized steel



compatible with Extravase 1/2 pot



smooth or rough surface



fixings to the ground



Waranty 24 months

Model	Code	Dimensions [mm]	Compatibility
1/2 Zebra G95/1800 Multicolor*	TC 002 303	Ø 1820 x r 910 x h 450 x d 550	Extravase 1/2 80
1/2 Zebra G95/1800 Monocolor**	TC 002 303...	Ø 1820 x r 910 x h 450 x d 550	Extravase 1/2 80
1/2 Zebra G95/1900 Multicolor*	TC 002 305	Ø 1900 x r 950 x h 450 x d 550	Extravase 1/2 80
1/2 Zebra G95/1900 Monocolor**	TC 002 305...	Ø 1900 x r 950 x h 450 x d 550	Extravase 1/2 80

● *Multicolor - A ready set of antique colors or RAL colors

● **Monocolor - One selected antique color or RAL color



1 - green



2 - gold



3 - copper



4 - black



RAL 7001*



RAL 1004



RAL 2000



RAL 4006



RAL 5012



RAL 7001*



RAL 9016



RAL 6034



RAL 5008



RAL 1015

antique colors

RAL vivid colours

RAL fading colours

ARE YOU LOOKING FOR A PRODUCT IN A DIFFERENT COLOR? Ask your sales advisor about the details.

*RAL 7001 - the constant colour of the rack with supporting feet and the first ring

1/2 Zebra G95/1800 Multicolor

Ø 1820 x r 910 x h 450 x d 550 mm

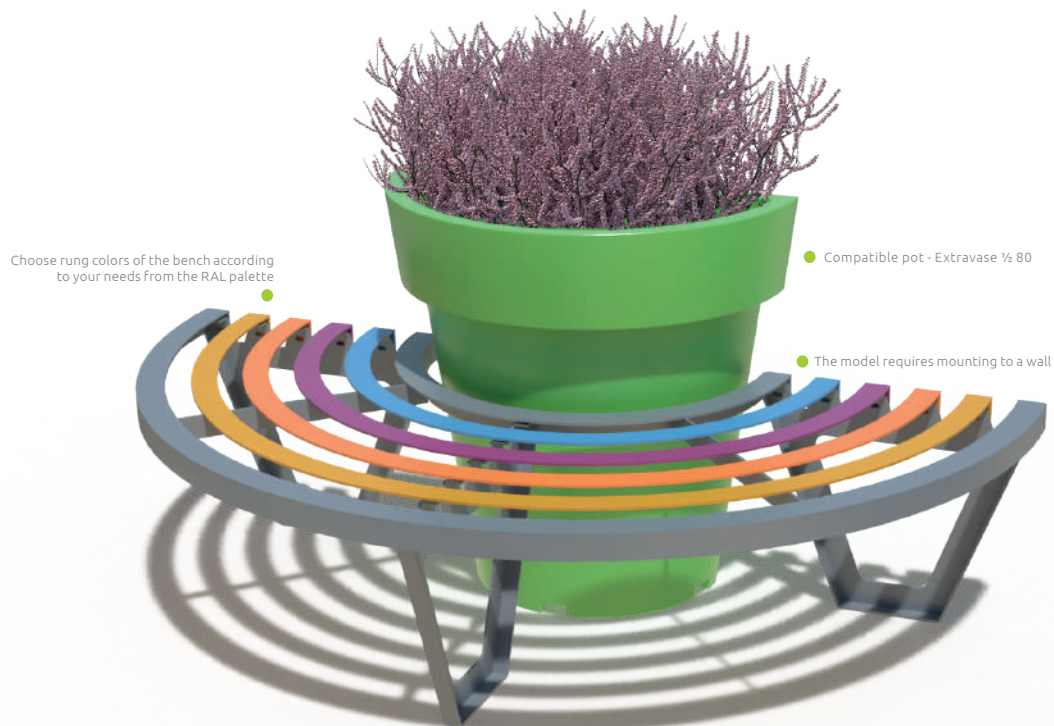

Option available: 1/2 Zebra G95/1900 means a wider diameter of the bench

front view



sketch

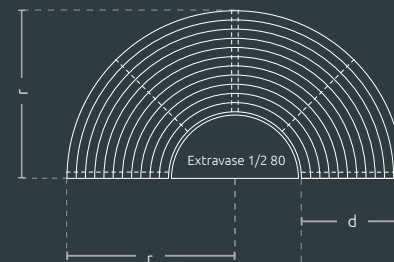

side view

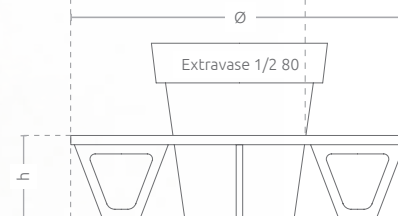

Round Bench Zebra 120

This city bench designed to create a set with Gianto 120, in a circular and semicircular shape, guarantees not only high comfort of use but also an attractive visual effect. A steel bench and polyethylene used in the production process of the pot assure resistance, regardless of the weather conditions. Each bench rung can have any color.

Features



a wide range of colors



powder coating RAL



hot-dip galvanized steel



compatible with the Gianto pot



smooth or rough surface



fixings to the ground



Waranty 24 months

Model	Code	Dimensions [mm]	Compatibility
Zebra G120/2000 Multicolor*	TC 002 404	Ø 2000 × h 450 × d 550	Gianto 120
Zebra G120/2000 Monocolor**	TC 002 404...	Ø 2000 × h 450 × d 550	Gianto 120

● *Multicolor - A ready set of antique colors or RAL colors

● **Monocolor - One selected antique color or RAL color



1 - green



2 - gold



3 - copper



4 - black



RAL 7001*



RAL 1004



RAL 2000



RAL 4006



RAL 5012



RAL 7001*



RAL 9016



RAL 6034



RAL 5008



RAL 1015

antique colors

RAL vivid colours

RAL fading colours

ARE YOU LOOKING FOR A PRODUCT IN A DIFFERENT COLOR? Ask your sales advisor about the details.

*RAL 7001 - the constant colour of the rack with supporting feet and the first ring

Ø 2000 × h 450 × d 550 mm



● Compatible pot- Gianto 120

Choose rung colors of the bench according to your needs from the RAL palette

● Fixing to the ground (optional)

front view



sketch

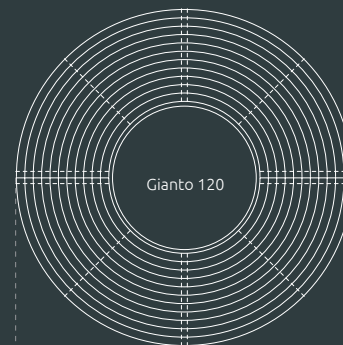

side view

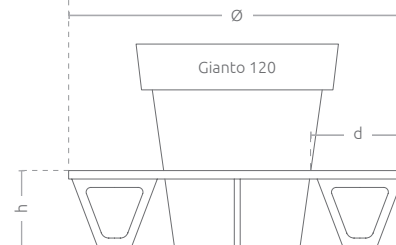

Round Bench Zebra 120 1/2

This city bench designed to create a set with Extravase 1/2 100, in a circular and semicircular shape, guarantees not only high comfort of use but also an attractive visual effect. A steel bench and polyethylene used in the production process of the pot assure resistance, regardless of the weather conditions. Each bench rung can have any color.

Features



a wide range of colors



powder coating RAL



hot-dip galvanized steel



compatible with Extravase 1/2 pot



smooth or rough surface



fixings to the ground



Waranty 24 months

Model	Code	Dimensions [mm]	Compatibility
1/2 Zebra G120/2000 Multicolor*	TC 002 308	Ø 2000 × r 1000 × h 450 × d 550	Extravase 1/2 100
1/2 Zebra G120/2000 Monocolor**	TC 002 308...	Ø 2000 × r 1000 × h 450 × d 550	Extravase 1/2 100

● *Multicolor - A ready set of antique colors or RAL colors

● **Monocolor - One selected antique color or RAL color



1 - green



2 - gold



3 - copper



4 - black



RAL 7001*



RAL 1004



RAL 2000



RAL 4006



RAL 5012



RAL 7001*



RAL 9016



RAL 6034



RAL 5008



RAL 1015

antique colors

RAL vivid colours

RAL fading colours

ARE YOU LOOKING FOR A PRODUCT IN A DIFFERENT COLOR? Ask your sales advisor about the details.

*RAL 7001 - the constant colour of the rack with supporting feet and the first ring

Ø 2000 × r 1000 × h 450 × d 550 mm



Choose rung colors of the bench according to your needs from the RAL palette

Compatible pot - Extravase 1/2 100

The model requires mounting to a wall

Fixing to the ground (optional)

front view



sketch

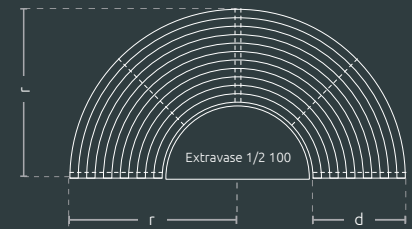

side view

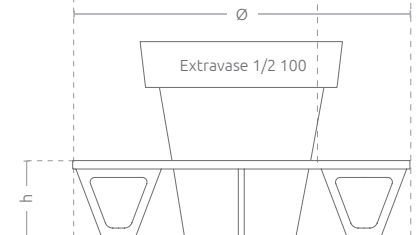









Bench with backrest Zebra

The city bench has a unique shape and color. Steel surface guarantees durability and resistance of the bench, regardless of the weather conditions. The bench is fixed with anchors, assuring resistance to mechanical damage. Each bench rung can have any color.

Features



a wide range of colors



powder coating RAL



hot-dip galvanized steel



smooth or rough surface



fixings to the ground



fixings to the ground



Waranty 24 months

Model	Code	Dimensions [mm]
Zebra Multicolor*	TC 002 307	w 1650 × d 700 × h 900 × ds 440 × hs 440
Zebra Monocolor**	TC 002 307...	w 1650 × d 700 × h 900 × ds 440 × hs 440

● *Multicolor - A ready set of antique colors or RAL colors

● **Monocolor - One selected antique color or RAL color



1 - green



2 - gold



3 - copper



4 - black



RAL 7001*



RAL 1004



RAL 2000



RAL 4006



RAL 5012



RAL 7001*



RAL 9016



RAL 6034



RAL 5008



RAL 1015

antique colors

RAL vivid colours

RAL fading colours

ARE YOU LOOKING FOR A PRODUCT IN A DIFFERENT COLOR? Ask your sales advisor about the details.

*RAL 7001 - the constant colour of the rack with supporting feet and the first ring

Zebra Multicolor

w 1650 x d 700 x h 900 x ds 440 x hs 440 mm

Choose rung colors of the bench according to your needs from the RAL palette

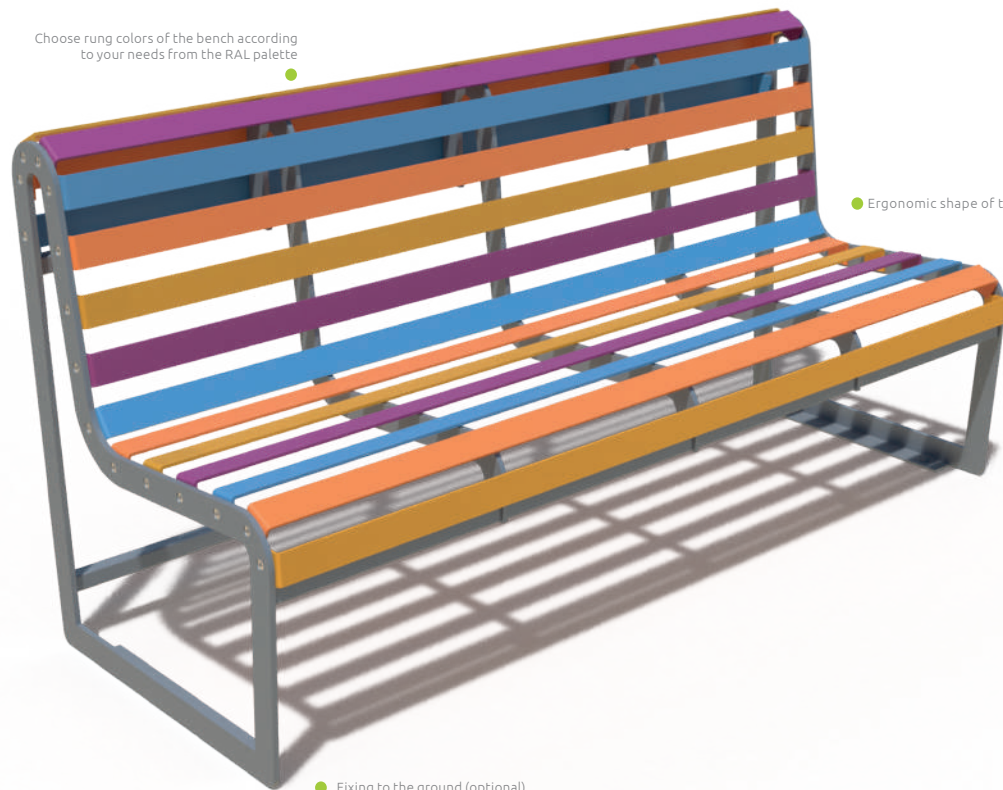

Ergonomic shape of the seat

Fixing to the ground (optional)

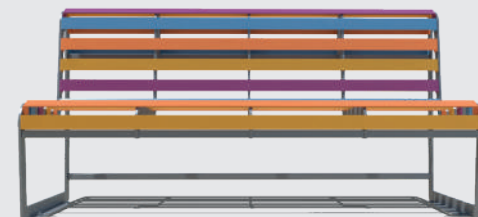

sketch

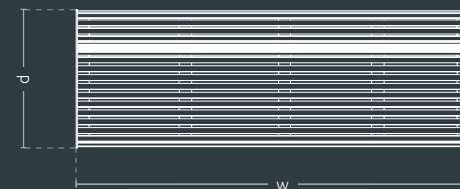

side view

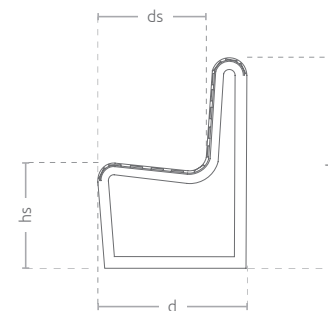

Bench without backrest Zebra Basic

The city bench has a unique shape and color. Steel surface guarantees durability and resistance of the bench, regardless of the weather conditions. The bench is fixed with anchors, assuring resistance to mechanical damage. Each bench rung can have any color.

Features



a wide range of colors



powder coating RAL



hot-dip galvanized steel



smooth or rough surface



fixings to the ground



fixings to the ground



Waranty 24 months

Model	Code	Dimensions [mm]
Zebra Basic Multicolor* Horizontal	TC 002 309	w 1650 × h 440 × ds 580
Zebra Basic Monocolor** Horizontal	TC 002 309...	w 1650 × h 440 × ds 580

● *Multicolor - A ready set of antique colors or RAL colors

● **Monocolor - One selected antique color or RAL color



1 - green



2 - gold



3 - copper



4 - black



RAL 7001*



RAL 1004



RAL 2000



RAL 4006



RAL 5012



RAL 7001*



RAL 9016



RAL 6034



RAL 5008



RAL 1015

antique colors

RAL vivid colours

RAL fading colours

ARE YOU LOOKING FOR A PRODUCT IN A DIFFERENT COLOR? Ask your sales advisor about the details.

*RAL 7001 - the constant colour of the rack with supporting feet and the first ring

Zebra Basic Multicolor Horizontal

w 1650 x h 440 x ds 580 mm

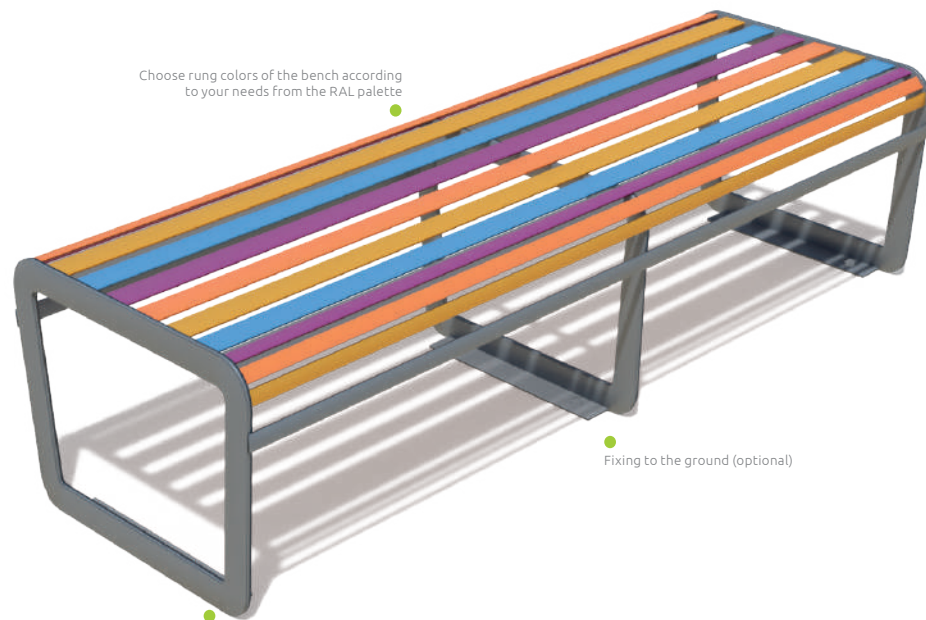

Choose rung colors of the bench according to your needs from the RAL palette

Fixing to the ground (optional)

Additional option - lockable wheels



front view

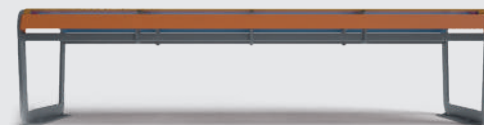

sketch

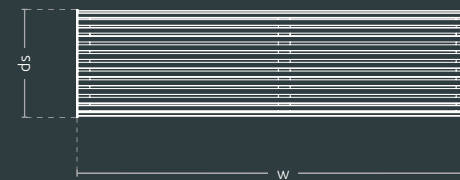

side view

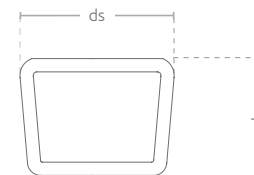





WAVE

Nature and functionality

Nature and functionality – these are the elements from which the collection of urban furniture WAVE arose from. A consistent effect assure the Gianto pot, with its classical form and vivid colors, as well as unique seats with their colorful finish. The WAVE collection has a number of advantages – any combination of colors, container sizes and bench sizes allow to adapt the furniture to any space: from the main square to the kindergarten playground. A simple combination of each seat module provides next options of arrangement. Solid steel and resistant polyethylene guarantee the use for many years without any problems.



Quarter Bench for Gianto

A quarter bench is compatible with a Gianto pot. This carefully formed seat with a round shape, assures aesthetic visual effect and comfort of use. The steel surface of the bench and polyethylene used in a pot, guarantee that its form will remain unchanged for years, regardless of the weather conditions.

Features



compatible with the whole collection



powder coating RAL



hot-dip galvanized steel



a seat covered with zinc undercoat



compatible with the Gianto pot



fixings to the ground



Waranty 24 months

Model	Code	Dimensions [mm]	Compatibility
1/4 80	TC 003 401	h 450 × d 555 × w 870	Gianto 80
1/4 95	TC 003 402	h 450 × d 555 × w 935	Gianto 95
1/4 120	TC 003 403	h 450 × d 555 × w 1000	Gianto 120



1 - green



2 - gold



3 - copper



4 - black

antique colors

ARE YOU LOOKING FOR A PRODUCT IN A DIFFERENT COLOR? Ask your sales advisor about the details.

h 450 x d 555 x w 870 mm



Combine any elements-create sets Wave

Compatible pot - Gianto 80/95/120

Fixing to the ground (optional)

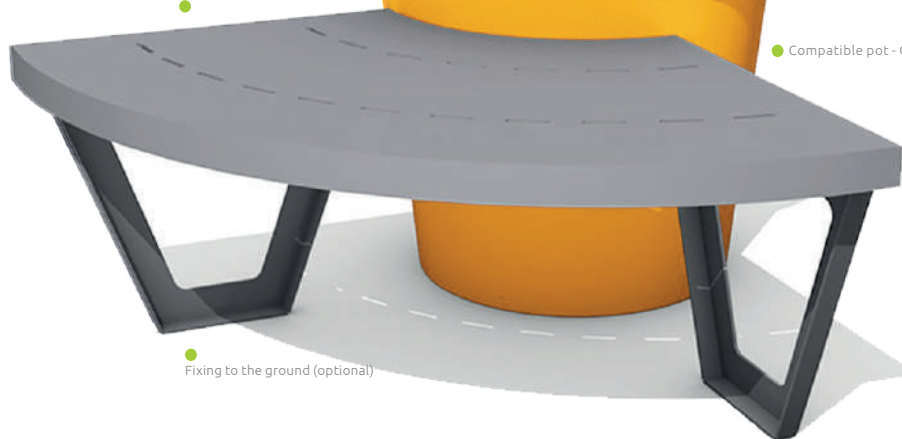

front view



sketch

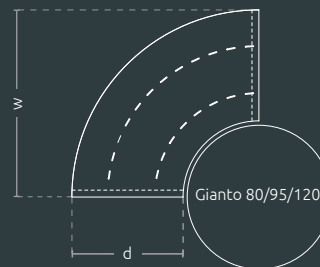

side view

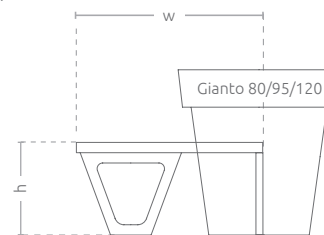

Half Bench for Gianto

This half bench is compatible with a Gianto pot. A carefully formed seat with a round shape, assures an aesthetic visual effect and comfort of use. The steel surface of the bench and polyethylene used in a pot, guarantee that its form will remain unchanged for years, regardless of the weather conditions.

Features



compatible with the whole collection



powder coating RAL



hot-dip galvanized steel



a seat covered with zinc undercoat



compatible with the Gianto pot



fixings to the ground



Waranty 24 months

Model	Code	Dimensions [mm]	Compatibility
M80	TC 003 302	Ø 1740 × r 870 × h 450 × d 555	Gianto 80
M95	TC 003 301	Ø 1870 × r 935 × h 450 × d 555	Gianto 95
M120	TC 003 303	Ø 2000 × r 1000 × h 450 × d 555	Gianto 120



1 - green



2 - gold



3 - copper



4 - black

antique colors

ARE YOU LOOKING FOR A PRODUCT IN A DIFFERENT COLOR? Ask your sales advisor about the details.

M95

Ø 1870 x r 935 x h 450 x d 555 mm



front view



sketch

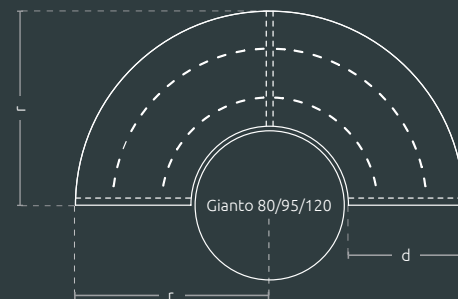

side view

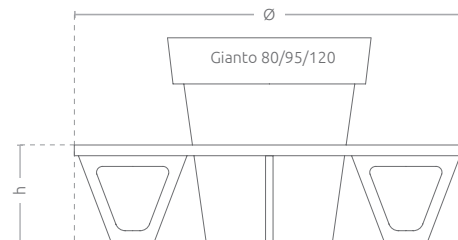

Pointed Bench for Gianto

This urban bench is compatible with a Gianto pot. A carefully formed seat with a semi-circular shape, assures an aesthetic visual effect and comfort of use. The steel surface of the bench and polyethylene used in a pot, guarantee that its form will remain unchanged for years, regardless of the weather conditions.

Features



compatible with the whole collection



powder coating RAL



hot-dip galvanized steel



a seat covered with zinc undercoat



compatible with the Gianto pot



fixings to the ground



Warranty 24 months

Model	Code	Dimensions [mm]	Compatibility
Pointed Bench Right-Handed S80P	TC 003 703	w 980 × y 555 × h 450 × d 555	Gianto 80
Pointed Bench Left-Handed S80L	TC 003 704	w 980 × y 555 × h 450 × d 555	Gianto 80
Pointed Bench Right-Handed S95P	TC 003 701	w 1010 × y 575 × h 450 × d 555	Gianto 95
Pointed Bench Left-Handed S95L	TC 003 702	w 1010 × y 575 × h 450 × d 555	Gianto 95
Pointed Bench Right-Handed S120P	TC 003 705	w 1225 × y 730 × h 450 × d 555	Gianto 120
Pointed Bench Left-Handed S120L	TC 003 706	w 1225 × y 730 × h 450 × d 555	Gianto 120



1 - green



2 - gold



3 - copper



4 - black

antique colors

ARE YOU LOOKING FOR A PRODUCT IN A DIFFERENT COLOR? Ask your sales advisor about the details.

Pointed Bench S80P i S80L

w 980 x y 555 x h 450 x d 555 mm

right-handed and left-handed S95 and S120 models
have a wider diameter

Compatible pot - Gianto 80/95/120

Fixing to the ground (optional)

front view



sketch

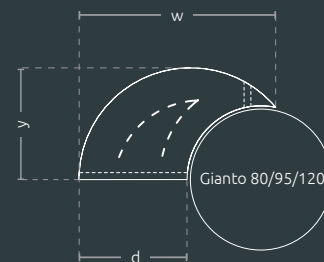

side view

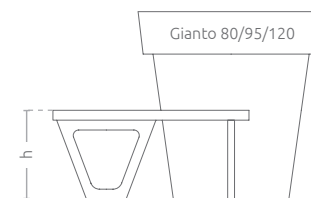

Solo Set for Gianto

A set of urban furniture which consists of two steel benches in various shapes. The set is compatible with Gianto pots, which together create an original and comfortable composition.

Features



compatible with the whole collection



powder coating RAL



hot-dip galvanized steel



a seat covered with zinc undercoat



compatible with the Gianto pot



fixings to the ground



Waranty 24 months

Model	Code	Dimensions [mm]	Compatibility
Solo Set (S80L + M80)	TC 003 801	Ø 1740 × w 1425 × h 450	Gianto 80
Solo Set (S95L + M95)	TC 003 802	Ø 1870 × w 1510 × h 450	Gianto 95
Solo Set (S120L + M120)	TC 003 808	Ø 2000 × w 1730 × h 450	Gianto 120



1 - green



2 - gold



3 - copper



4 - black

antique colors

ARE YOU LOOKING FOR A PRODUCT IN A DIFFERENT COLOR? Ask your sales advisor about the details.

Solo Set (S80L + M80)

Ø 1740 x w 1425 x h 450 mm



Solo Set S95L + M95 and S120L + M120 have a wider diameter

front view



sketch

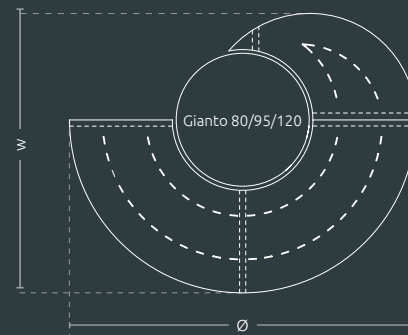

side view



Doble Set for Gianto

A set of urban furniture which consists of four steel benches in various shapes. The benches are compatible with Gianto pots, which together create an original and comfortable composition.

Features



compatible with the whole collection



powder coating RAL



hot-dip galvanized steel



a seat covered with zinc undercoat



compatible with the Gianto pot



fixings to the ground



Warranty 24 months

Model	Code	Dimensions [mm]	Compatibility
Doble Set (S95L + M95 + M80 + S80L)	TC 003 803	w 1805 x l 3055	Gianto 80, 95



1 - green



2 - gold



3 - copper



4 - black

antique colors

ARE YOU LOOKING FOR A PRODUCT IN A DIFFERENT COLOR? Ask your sales advisor about the details.

Doble Set (S95L + M95 + M80 + S80L)

w 1805 x l 13055 mm



front view



sketch

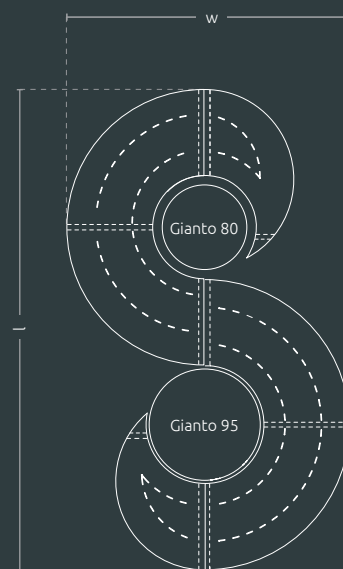

Triple Set for Gianto

A set of urban furniture which consists of five steel benches in various shapes. The benches are compatible with Gianto pots, which together create an original and comfortable composition.

Features



compatible with the whole collection



powder coating RAL



hot-dip galvanized steel



a seat covered with zinc undercoat



compatible with the Gianto pot



fixings to the ground



Waranty 24 months

Model	Code	Dimensions [mm]	Compatibility
Triple Set (S95L + M95 + M80 + M95 + S95P)	TC 003 804	w 1805 x l 4370	Gianto 80, 95
Triple Set (S95L + M95 + M80 + M80 + S80P)	TC 003 805	w 1805 x l 4240	Gianto 80, 95



1 - green



2 - gold



3 - copper



4 - black

antique colors

ARE YOU LOOKING FOR A PRODUCT IN A DIFFERENT COLOR? Ask your sales advisor about the details.

Triple Set (S95L + M95 + M80 + M80 + S80P)

w 1805 x L 4370 mm



sketch

Variant A

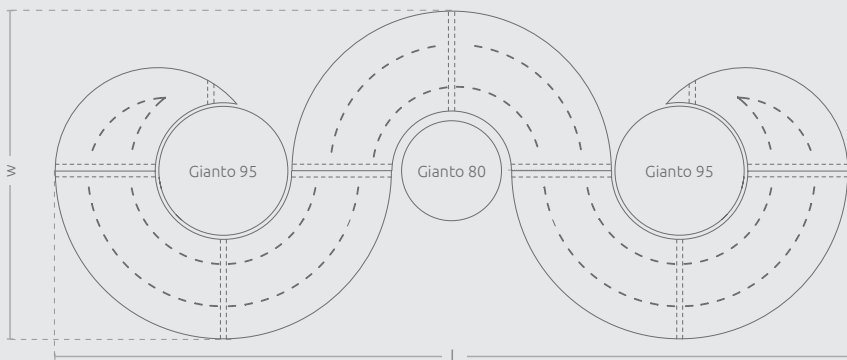

sketch

Variant A

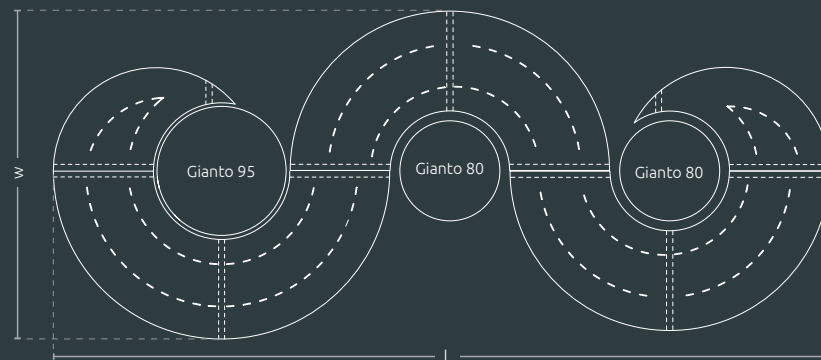

Tri Set for Gianto

A set of urban furniture which consists of three steel benches with round shapes. The benches are compatible with two or three Gianto pots, which can be planted with any plants. The composition is stable thanks to the fixing to the ground.

Features



compatible with the whole collection



powder coating RAL



hot-dip galvanized steel



a seat covered with zinc undercoat



compatible with the Gianto pot



fixings to the ground



Waranty 24 months

Model	Code	Dimensions [mm]	Compatibility
Tri Set (S95L + M95 + 1/4 95 + 1/4 80 + S80P)	TC 003 806	w 3120 x l 2760	Gianto 80, 95



1 - green



2 - gold



3 - copper



4 - black

antique colors

ARE YOU LOOKING FOR A PRODUCT IN A DIFFERENT COLOR? Ask your sales advisor about the details.

Tri Set (S95L + M95 + 1/4 95 + 1/4 80 + S80P)

w 3120 x l 2760 mm



front view



sketch

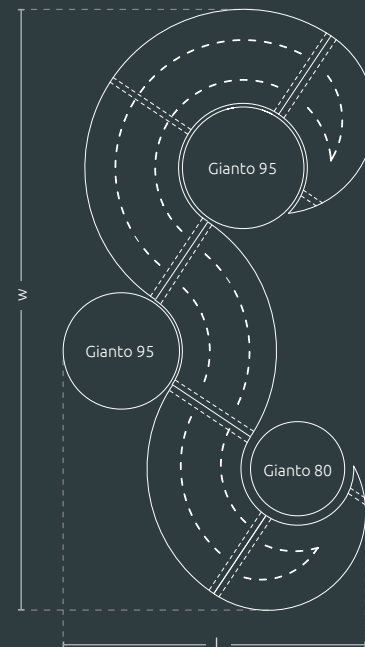

Quintus Set for Gianto

A set of urban furniture which consists of five joint steel benches in a rounded form. The set can be diversified by adding up to five Gianto pots. Powder coating guarantees that the bench will remain in an unchanged condition for many years, regardless of the weather conditions.

Features



compatible with the whole collection



powder coating RAL



hot-dip galvanized steel



a seat covered with zinc undercoat



compatible with the Gianto pot



fixings to the ground



Waranty 24 months

Model	Code	Dimensions [mm]	Compatibility
Quintus Set (S95L + 1/4 95 + 1/4 80 + M80 +1/4 80 +1/4 95 + S95P)	TC 003 807	w 4300 × l 2760	Gianto 80, 95



1 - green



2 - gold



3 - copper



4 - black

antique colors

ARE YOU LOOKING FOR A PRODUCT IN A DIFFERENT COLOR? Ask your sales advisor about the details.

Quintus Set (S95L + 1/4 95 + 1/4 80 + M80 + 1/4 80 + 1/4 95 + S95P)

w 3300 x L 2760 mm



front view



sketch

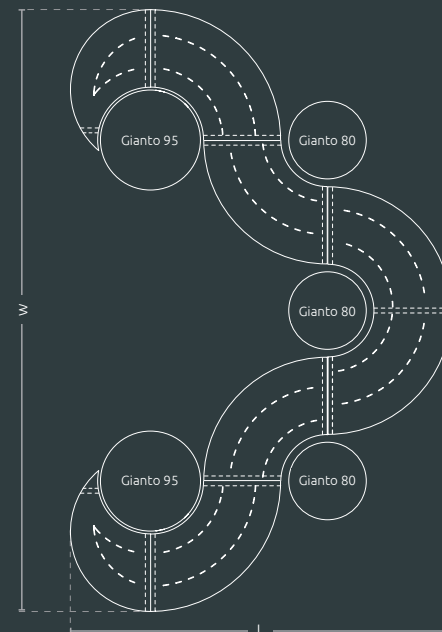









URBANA

Furniture For Urban Jungle

Classical solutions on an urban scale. The Urbana Collection is a line of modular elements for public spaces. A bench, pot, tourist information stand or bicycle rack can be presented as individual elements, but also they can create a coherent composition in the space or become its main accent. Their high weight means that there is no need of fixing the furniture to the ground and the effect is immediate without any construction works. Steel used in the production process of the Urbana Collection guarantees that the decorations resist severe weather conditions but also acts of vandalism. They are solid, aesthetic and functional solutions for years.



Urban Pot Urbana L

A small flower pot made from steel. This model with the capacity of almost 200 liters provides the possibility of launching significant number of plants into the surroundings, even in the places without any natural substrate. A solid container can go with other elements of the collection.

Features



compatible with the whole collection



powder coating RAL



frame - hot-dip galvanized steel



walls - hot-dip galvanized steel



reinforced bottom



heavy and stable



styrofoam insulation



adjustable height



Waranty 24 months

Model	Code	Dimensions [mm]	Capacity
Urban Pot Urbana L	TC 001 101	w 1040 × h 700 × d 555	176 l



1 - green



2 - gold



3 - copper



4 - black

antique colors



Personalized Model
(any pot size - according to your needs)

ARE YOU LOOKING FOR A PRODUCT IN A DIFFERENT COLOR? Ask your sales advisor about the details.

Urban Pot Urbana L

w 1040 × h 700 × d 555 mm



front view



sketch

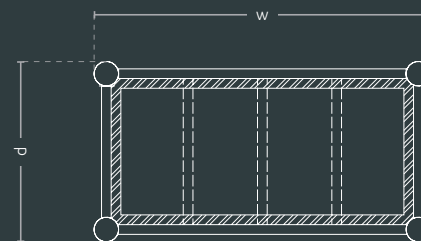

view

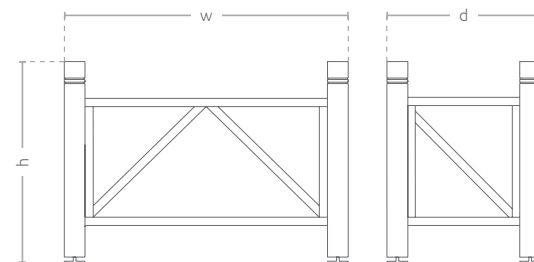

Urban Pot Urbana XL

A big pot made from steel. The largest model with the capacity of almost 700 liters allows to launch the maximum number of plants into the surroundings, even into places without natural substrate. A solid container can go together with other elements of the collection.

OPTIONAL



stabilizing holders to a tree

Features



compatible with the whole collection



powder coating RAL



frame - hot-dip galvanized steel



walls - hot-dip galvanized steel



reinforced bottom



heavy and stable



styrofoam insulation



adjustable height



Waranty 24 months

Model	Code	Dimensions [mm]	Capacity
Urban Pot Urbana XL	TC 001 102	w 1040 × h 1145 × d 1040	684 l



1 - green



2 - gold



3 - copper



4 - black

antique colors



Personalized Model
(any pot size - according to your needs)

ARE YOU LOOKING FOR A PRODUCT IN A DIFFERENT COLOR? Ask your sales advisor about the details.

w 1040 x h 1145 x d 1040 mm



Choose color which remains unchanged for years

Powder coating guarantees that a color of the pot will not change under the influence of various weather conditions for long years

front view

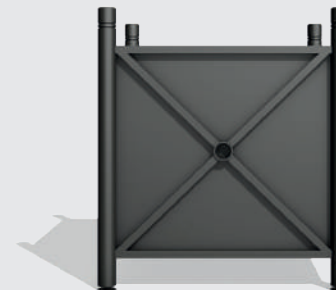

sketch

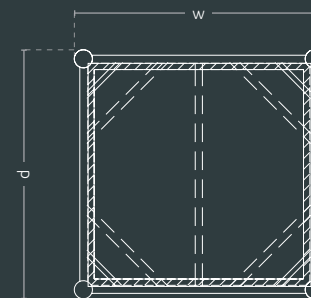

view

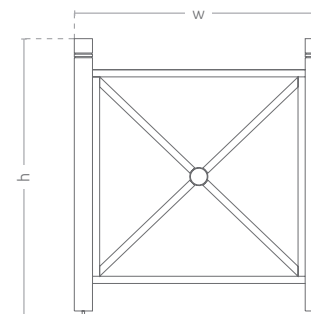

Bicycle Rank Urbana L

The steel bicycle rank is adjusted to the L pot. It was created in response to the growing trend of riding a bike. An additional function of the construction is an information stand with a map. Steel spans guarantee safe storage of the vehicles and resistance to mechanical damage.

Features



compatible with the whole collection



powder coating RAL



frame - hot-dip galvanized steel



walls - hot-dip galvanized steel



reinforced bottom



heavy and stable



styrofoam insulation



adjustable height



Waranty 24 months

Model	Code	Dimensions [mm]	Capacity
Bicycle Rank Urbana L	TC 001 502	w 1040 × hc 1695 × h 700 × d 855	176 l



1 - green



2 - gold



3 - copper



4 - black

antique colors



Personalized Model
(any pot size - according to your needs)

ARE YOU LOOKING FOR A PRODUCT IN A DIFFERENT COLOR? Ask your sales advisor about the details.

Bicycle Rank Urbana L

w 1040 x hc 1695 x h 700 x d 855 mm

A single decoration or an element of a bigger composition ●



● A solid rank can be a single decoration and does not require additional installation or excavation

front view



sketch

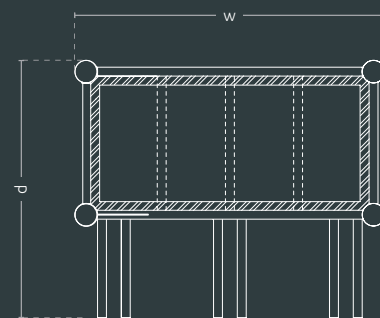

view

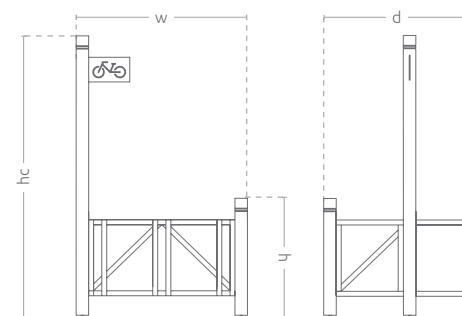

Bicycle Rank Urbana XL

The steel bicycle rank compatible with the XL pot. It was created in response to the growing trend of riding a bike. An additional function of the construction is an information stand with a map. Steel spans guarantee safe storage of the vehicles and resistance to mechanical damage.

OPTIONAL



stabilizing holders to a tree

Features



compatible with the whole collection



powder coating RAL



frame - hot-dip galvanized steel



walls - hot-dip galvanized steel



reinforced bottom



heavy and stable



styrofoam insulation



adjustable height



Waranty 24 months

Model	Code	Dimensions [mm]	Capacity
Bicycle Rank Urbana XL	TC 001 501	w 1040 x hc 1695 x h 1145 x d 1340	684 l



1 - green



2 - gold



3 - copper



4 - black

antique colors



Personalized Model
(any pot size - according to your needs)

ARE YOU LOOKING FOR A PRODUCT IN A DIFFERENT COLOR? Ask your sales advisor about the details.

Bicycle Rank Urbana XL

w 1040 × hc 1695 × h 1145 × d 1340 mm



● Safe storage of bikes

● The wheel holders are made from heavy and stable steel which prevents their theft and damage

front view



sketch

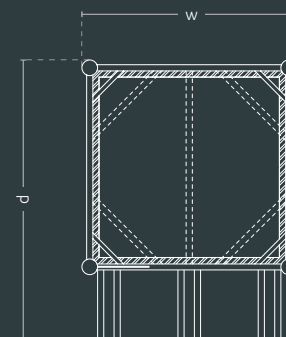

view

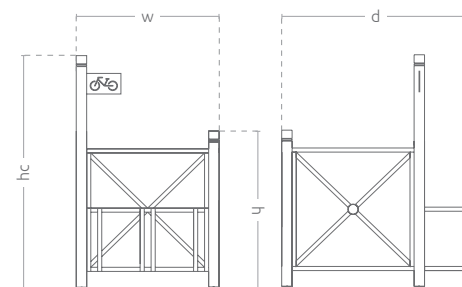

Tourist Information Stand Urbana L

A tourist information stand built on a solid, steel construction. It is an element of the collection thanks to which tourists and guests will be provided with required information: city maps, welcome leaflets or timetables of public transport. The product is compatible with the L pot, which allows to bring some additional plants to the surroundings.

Features



compatible with the whole collection



powder coating RAL



frame - hot-dip galvanized steel



walls - hot-dip galvanized steel



reinforced bottom



heavy and stable



styrofoam insulation



adjustable height



Waranty 24 months

Model	Code	Dimensions [mm]	Capacity
Tourist Information Stand Urbana L	TC 001 402	w 1040 × hc 1695 × h 700 × d 550	176 l



1 - green



2 - gold



3 - copper



4 - black

antique colors



Personalized Model
(any pot size - according to your needs)

ARE YOU LOOKING FOR A PRODUCT IN A DIFFERENT COLOR? Ask your sales advisor about the details.

Tourist Information Stand Urbana L

w 1040 x hc 1695 x h 700 x d 550 mm

Add graphic elements of the stand



An information board makes it easy to present consistent visual identification of the surroundings



front view

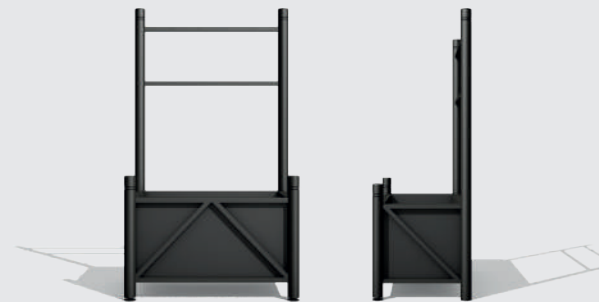

sketch

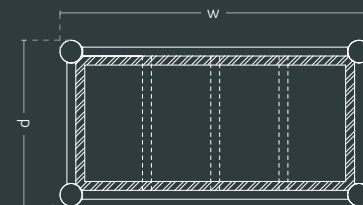

view

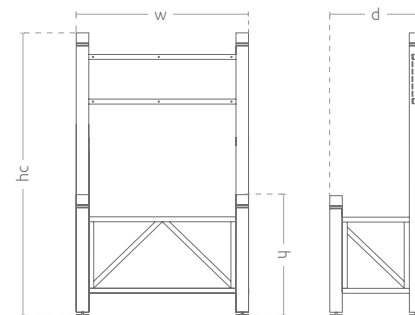

Tourist Information Stand Urbana XL

A tourist information stand built on a solid, steel construction. It is an element of the collection thanks to which tourists and guests will be provided with required information: city maps, welcome leaflets or timetables of public transport. The product is compatible with the XL pot, which allows to bring some additional plants to the surroundings.

OPTIONAL



stabilizing holders to a tree

Features



compatible with the whole collection



powder coating RAL



frame - hot-dip galvanized steel



walls - hot-dip galvanized steel



reinforced bottom



heavy and stable



styrofoam insulation



adjustable height



Waranty 24 months

Model	Code	Dimensions [mm]	Capacity
Tourist Information Stand Urbana XL	TC 001 401	w 1040 × hc 1695 × h 1145 × d 1040	684 l



1 - green



2 - gold



3 - copper



4 - black

antique colors



Personalized Model
(any pot size - according to your needs)

ARE YOU LOOKING FOR A PRODUCT IN A DIFFERENT COLOR? Ask your sales advisor about the details.

w 1040 × hc 1695 × h 1145 × d 1040 mm



Stabilizing brackets for the trees and larger decorative plants allow for efficient implementation of the greenery into the surrounding

front view

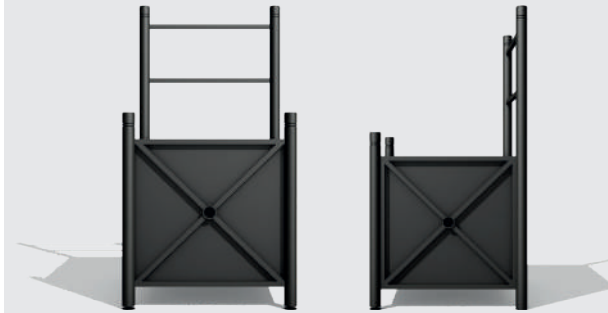

sketch

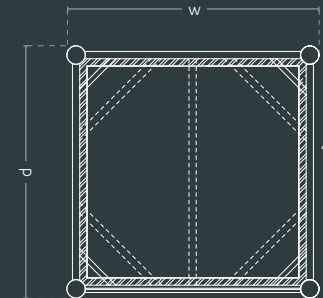

view

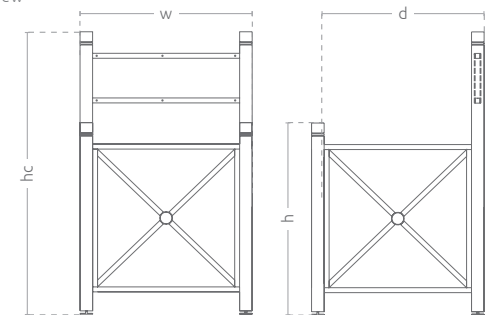



CAMPO
SANZOLO
PARROCCHIA
S. GIULIANO



Urban Pot Urbana 1/4

A steel pot in a 1/4 circle shape. This model allows to create various compositions, not only in corners but also on a circular concept. It provides an opportunity to launch into the surroundings a significant number of plants. The solid container can go with other elements of the collection.

Features



powder coating RAL



frame - hot-dip galvanized steel



walls - hot-dip galvanized steel



reinforced bottom



heavy and stable



styrofoam insulation



adjustable height



Waranty 24 months

Model	Code	Dimensions [mm]	Capacity
Urban Pot Urbana 1/4	TC 001 103	wo 1180 × hc 700 × wi 830 × h 590 × d 410	176 l



1 - green



2 - gold



3 - copper



4 - black

antique colors



Personalized Model
(any pot size - according to your needs)

ARE YOU LOOKING FOR A PRODUCT IN A DIFFERENT COLOR? Ask your sales advisor about the details.

w 1040 × hc 1695 × h 1145 × d 1040 mm



● Set of pots ¼

● The pot insulated with styrofoam – an insulation layer, which assures optimal conditions for plants

front view



sketch

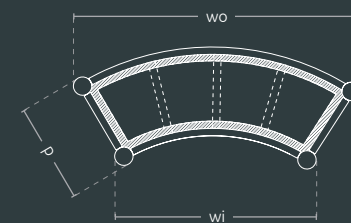

side view

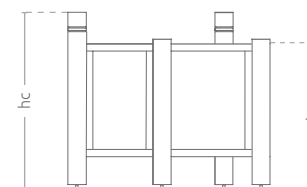

Urban Bench Urbana L

An urban bench based on the steel elements with a seat made of synthetic wood. Steel, hot-dip galvanized legs are stylish but also resistant to the acts of vandalism. A solid seat guarantees comfortable rest.

Features



compatible with the whole collection



powder coating RAL



hot-dip galvanized steel



fixings to the ground



a bench seat made from composite board



Waranty 24 months

Model	Code	Dimensions [mm]
Urban Bench Urbana L	TC 001 302	w 1800 × h 450 × ds 430



1 - green



2 - gold



3 - copper



4 - black

antique colors



Personalized Model
(any pot size - according to your needs)

ARE YOU LOOKING FOR A PRODUCT IN A DIFFERENT COLOR? Ask your sales advisor about the details.

Urban Bench Urbana L

w 1800 × h 450 × ds 430 mm

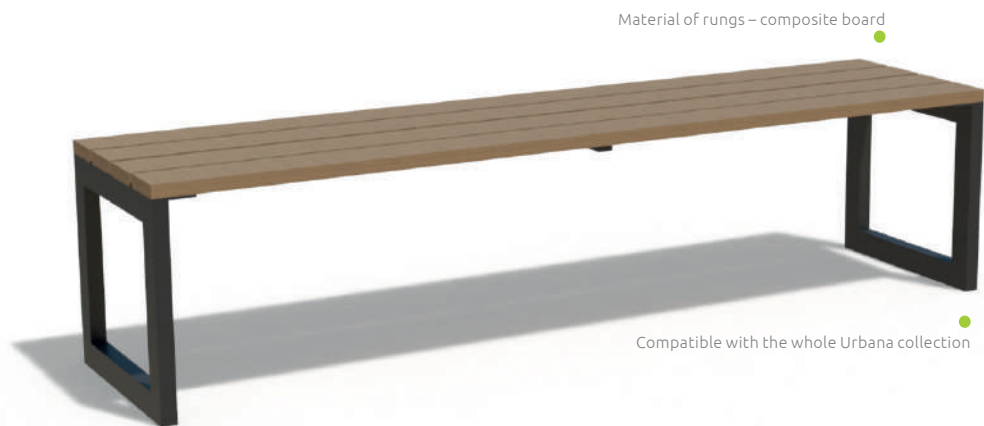

Material of rungs – composite board

Compatible with the whole Urbana collection

front view



sketch

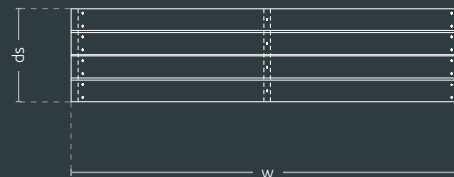

side view



Urban Bench Urbana XL

An urban bench based on steel elements with a seat made of synthetic wood. Steel galvanized legs are stylish but also resistant to the acts of vandalism. This solid seat guarantees comfortable rest.

Features



compatible with the whole collection



powder coating RAL



hot-dip galvanized steel



fixings to the ground



a bench seat made from composite board



Waranty 24 months

Model	Code	Dimensions [mm]
Urban Bench Urbana XL	TC 001 301	w 1800 × h 945 × d 550 × hs 450 × ds 390



1 - green



2 - gold



3 - copper



4 - black

antique colors



Personalized Model
(any pot size - according to your needs)

ARE YOU LOOKING FOR A PRODUCT IN A DIFFERENT COLOR? Ask your sales advisor about the details.

Urban Bench Urbana XL

w 1800 x h 945 x d 550 x hs 450 x ds 390 mm

Material of rungs – composite board

Compatible with the whole Urbana collection

front view



sketch

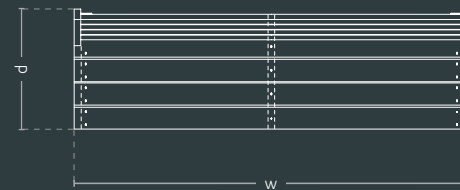

side view

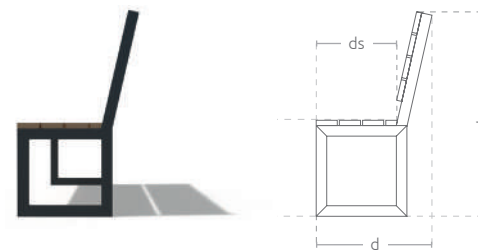

Railing Urbana L

A fully functional large railing, compatible with other urban furniture from the Urbana Collection. It is made from hot-dip galvanized steel, thus it is very durable and resistant to the acts of vandalism as well as changeable weather conditions. The product can be a part of some bigger composition, functioning as a fence, decoration or an element joining pots. The railing cannot remain an individual element without any pot or bench.

Features



compatible with the whole collection



powder coating RAL



hot-dip galvanized steel



Waranty 24 months

Model	Code	Dimensions [mm]
Railing Urbana L	TC 001 201	w 1400 × h 1145 × d 72



1 - green



2 - gold



3 - copper



4 - black

antique colors



Personalized Model
(any pot size - according to your needs)

ARE YOU LOOKING FOR A PRODUCT IN A DIFFERENT COLOR? Ask your sales advisor about the details.

Railing Urbana L

w 1400 × h 1145 × d 72 mm



front view

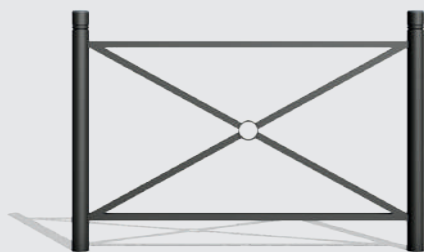

front view

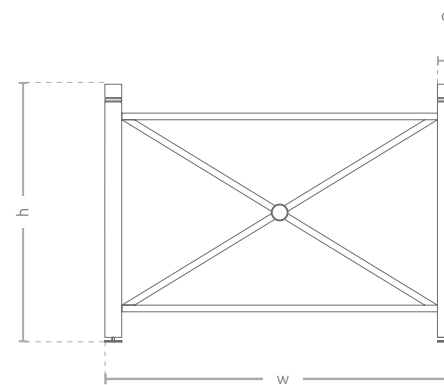

Railing Urbana XL

A fully functional large railing, compatible with other urban furniture from the Urbana Collection. It is made from hot-dip galvanized steel, thus it is very durable and resistant to the acts of vandalism as well as changeable weather conditions. The product can be a part of some bigger composition, functioning as a fence, decoration or an element joining pots. The railing cannot remain an individual element without any pot or bench.

Features



compatible with the whole collection



powder coating RAL



hot-dip galvanized steel



Waranty 24 months

Model	Code	Dimensions [mm]
Railing Urbana XL	TC 001 202	w 2800 × h 1145 × d 72



1 - green



2 - gold



3 - copper



4 - black

antique colors



Personalized Model
(any pot size - according to your needs)

ARE YOU LOOKING FOR A PRODUCT IN A DIFFERENT COLOR? Ask your sales advisor about the details.

Railing Urbana XL

w 2800 × h 1145 × d 72 mm

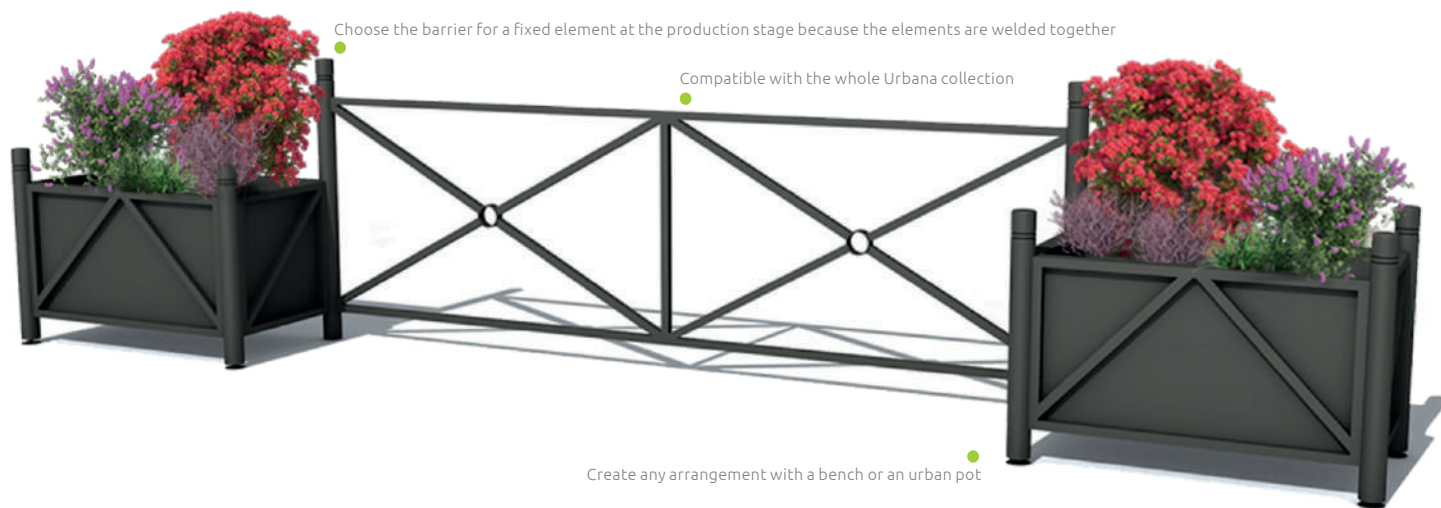

front view

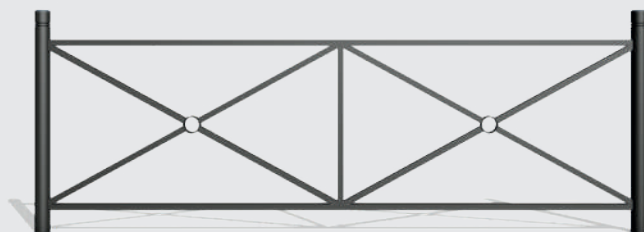

front view

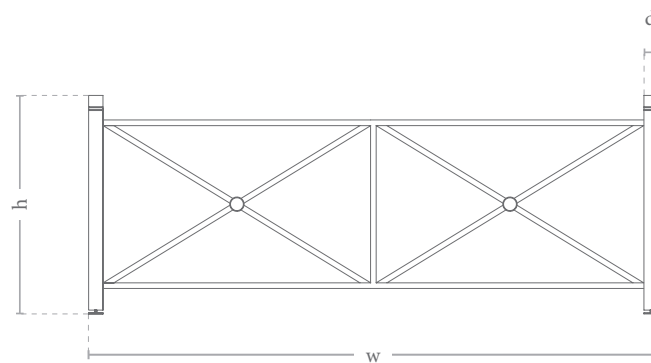



combine any elements

+

**CREATE
YOUR
ARRANGEMENT**

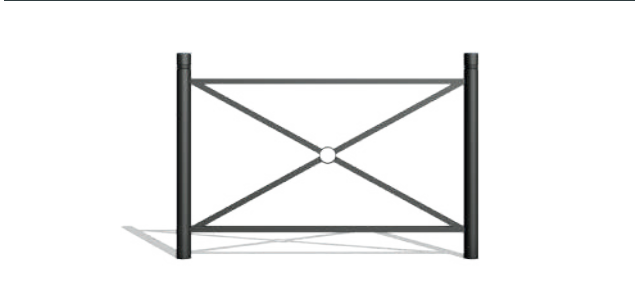

we suggest several options

the length of the set: approx. 5300 mm / the width of the set: approx. 1040 mm



collection

the length of the set approx. 2300 mm / the width of the set approx. 1470 mm



the length of the set: approx. 5180 mm / the width of the set: approx. 1040 mm



collection





FRANZ

tablo





Available colours

Antique colors

ARE YOU LOOKING FOR A PRODUCT IN A DIFFERENT COLOR?
Ask your sales advisor about the details.

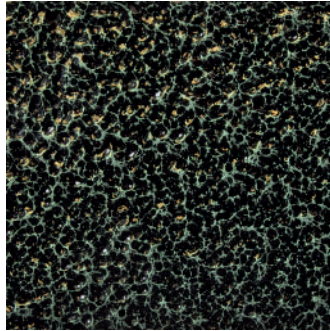

1 - GREEN

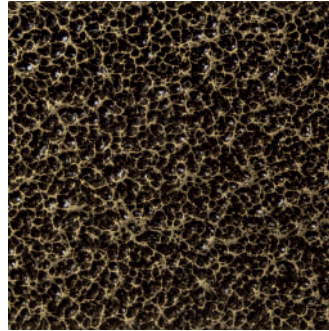

2 - GOLD

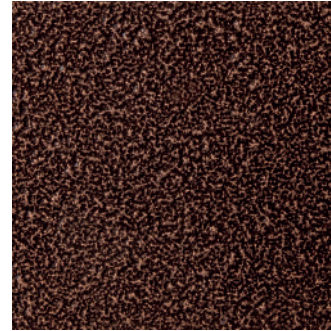

3 - COPPER

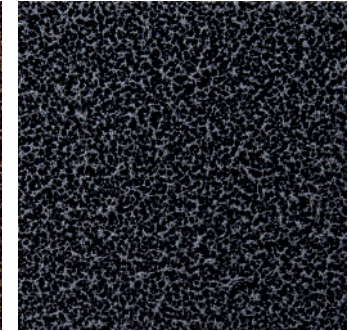

4 - BLACK

COLOURS

Colors RAL

ARE YOU LOOKING FOR A PRODUCT IN A DIFFERENT COLOR?
Ask your sales advisor about the details.

RAL VIVID COLOURS



RAL 7001*
Silver Grey



RAL 1004
Golden Yellow



RAL 2000
Yellow Orange



RAL 4006
Traffic Purple



RAL 5012
Light Blue

RAL FADING COLOURS

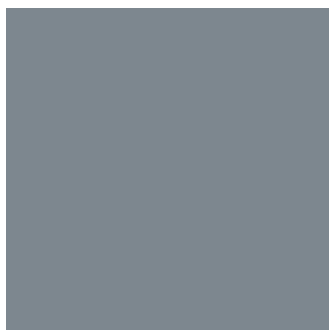

RAL 7001*
Silver Grey

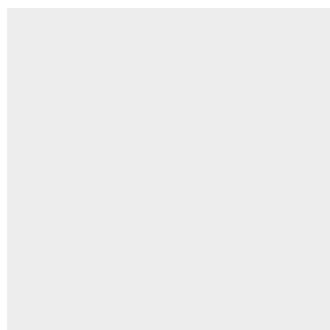

RAL 9016
Traffic White



RAL 6034
Pastel Turquoise



RAL 5008
Gray Blue



RAL 1015
Light Ivory

*RAL 7001 - the constant colour of the rack with supporting feet and the first ring

Contact

We will be happy to answer all your questions.

T: +48 68 455 62 69

E: info@terra-uk.eu

Terra Group
ul. Sowińskiego 42a
65-419 Zielona Góra

www.terracity.eu

Urban furniture collection



Terra[®]
Group



TerraCity - a brand of Terra Group

Terra Group

*Razem stworzymy
piękniejsze jutro!*

ul. Gen. Józefa Sowińskiego 42a
65-419 Zielona Góra

T: +48 68 455 62 69
F.: +48 68 414 54 25

www.terra-uk.eu

www.terracity.eu