



Urban Furniture Collection



Collections

zebra

Round Bench Zebra 80	6
Round Bench Zebra 80 1/2	8
Round Bench Zebra 95	10
Round Bench Zebra 95 1/2	12
Round Bench Zebra 120	14
Round Bench Zebra 120 1/2	16
Bench with backrest Zebra	20
Bench without backrest urbana Zebra Basic	22

urbana

Urban Pot Urbana L	28
Urban Pot Urbana XL	30
Bicycle Rank Urbana L	32
Bicycle Rank Urbana XL	34
Tourist Information Stand Urbana L	36
Tourist Information Stand Urbana XL	38
Urban Pot Urbana ¼	42
Urban Bench Urbana L	44
Urban Bench Urbana XL	46
Railing Urbana L	48
Railing Urbana XL	50

4

wave

Quarter Bench For Gianto	60
Half Bench For Gianto	62
Pointed Bench For Gianto	64
Solo Set For Gianto	66
Doble Set For Gianto	68
Triple Set For Gianto	70
Tri Set For Gianto	72
Quintus Set For Gianto	74

58

zebra

Nature all around







Relax in the city center and in the surroundings of plants – it is possible thanks to the furniture from the Zebra Collection. A characteristic feature of the line are round benches, which go together with Gianto pots. An additional advantage is fabulously colorful finish. It is essential that the seat may have various color options - each rung can go in any version and their final image is not limited in any way. This can be a great idea for the arrangement of the school playgrounds, parks or estate squares. The polyethylene pot and steel seat assure that their form will remain unchanged for years as well as their resistance to the various weather conditions and mechanical damage.



Round Bench Zebra 80













A round bench, compatible with Gianto 80, with a half-round shape guarantees an eye-catching visual effect but also comfort of use. A steel bench and polyethylene used in the production process assure resistance, regardless of the weather conditions. The colors of each bench rung can be chosen according to your needs.

Features

-  a wide range of colors
-  powder coating RAL
-  hot-dip galvanized steel
-  compatible with the Gianto pot
-  smooth or rough surface
-  fixings to the ground

Model	Code	Dimensions [mm]	Compatibility	Net Price
Zebra G80/1700 Multicolor	TC 002 401	Ø 1720 x h 450 x d 550	Gianto 80	1050 €
Zebra G80/1700 RAL	TC 002 401	Ø 1720 x h 450 x d 550	Gianto 80	788 €

Available Colors

												
RAL 7004	RAL 9016	RAL 6034	RAL 5008	RAL 3027	RAL 7016	RAL 5014	RAL 4001	RAL 3015	RAL 1004	RAL 7016 Terra 036	RAL 7043 Terra 040	RAL 8019 Terra 038

Multicolor 500 gloss
Multicolor 501 mat
RAL color¹

¹ (smooth gloss coating, smooth mat coating, slightly rough texture mat, scabrous texture gloss)

Zebra G80/1700 Multicolor

Ø 1720 x h 450 x d 550 mm

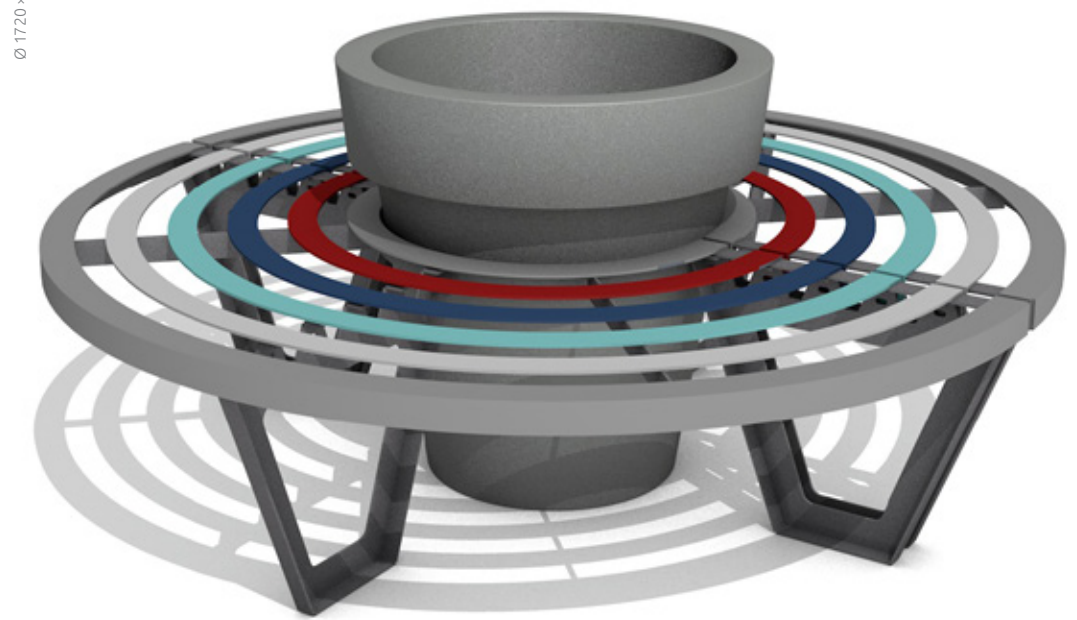



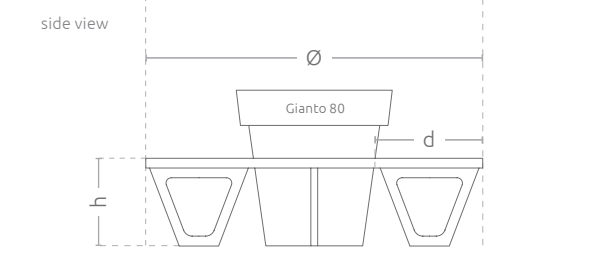
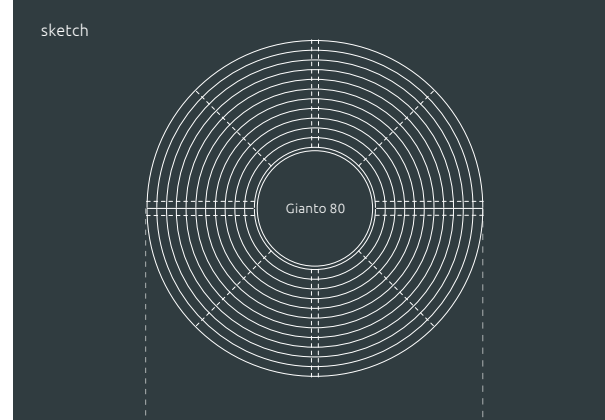

G80 choose rung colors of the bench according to your needs from the RAL palette, compatible pot- Gianto 80 fixing to the ground (optional)



Round Bench Zebra 80 1/2













This city bench, compatible with Gianto 80, in a semicircular shape guarantees attractive visual effect and comfort of use. A steel bench and polyethylene used in the production process of the pot assure resistance, regardless of the weather conditions. Each bench rung can have any color.

Features

-  a wide range of colors
-  powder coating RAL
-  hot-dip galvanized steel
-  compatible with the Gianto pot
-  smooth or rough surface
-  fixings to the ground

Model	Code	Dimensions [mm]	Compatibility	Net Price
1/2 Zebra G80/1700 Multicolor	TC 002 304	Ø 1720 × r 860 × h 450 × d 550	Gianto 80	630 €
1/2 Zebra G80/1700 RAL	TC 002 304	Ø 1720 × r 860 × h 450 × d 550	Gianto 80	473 €

Available Colors

												
RAL 7004	RAL 9016	RAL 6034	RAL 5008	RAL 3027	RAL 7016	RAL 5014	RAL 4001	RAL 3015	RAL 1004	RAL 7016 Terra 036	RAL 7043 Terra 040	RAL 8019 Terra 038

Multicolor 500 gloss
Multicolor 501 mat
RAL color¹

¹ (smooth gloss coating, smooth mat coating, slightly rough texture mat, scabrous texture gloss)

1/2 Zebra G80/1700 Multicolor

Ø 1720 × r 860 × h 450 × d 550 mm

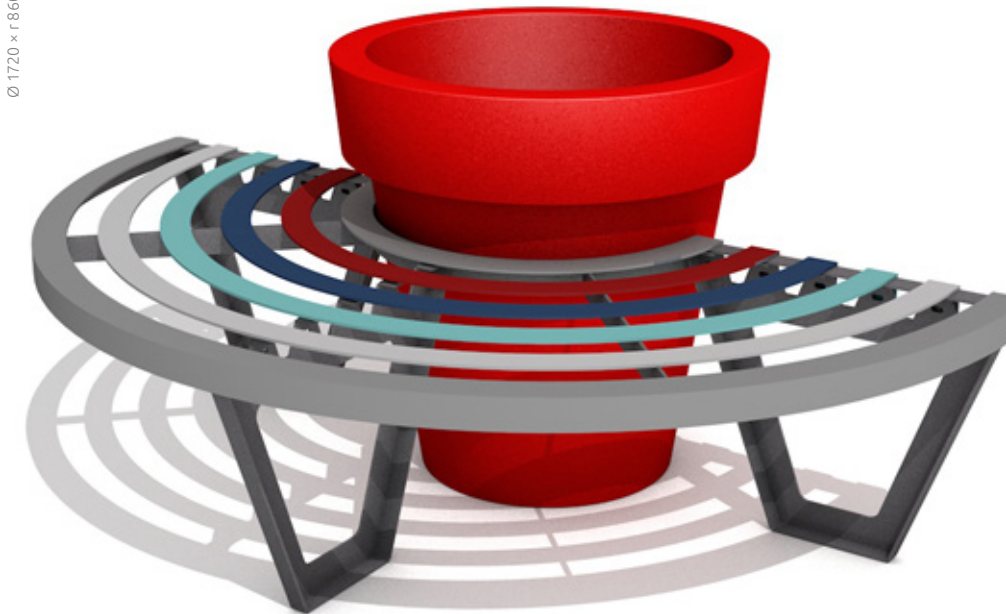

G80 1/2 each bench rung can have any color from the RAL palette compatible pot- Gianto 80

front view



sketch

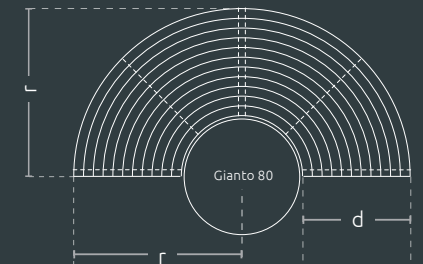







side view



Round Bench Zebra 95

This city bench, compatible with Gianto 95, in a circular and semicircular shape, guarantees not only comfort of use but also an attractive visual effect. Solid materials used in the production process of the bench guarantee durability and reliability of the construction for long years, even in unfavorable weather conditions. Each bench rung can have any color.

Features

-  a wide range of colors
-  powder coating RAL
-  hot-dip galvanized steel
-  compatible with the Gianto pot
-  smooth or rough surface
-  fixings to the ground

Model	Code	Dimensions [mm]	Compatibility	Net Price
Zebra G95/1800 Multicolor	TC 002 402	Ø 1820 × h 450 × d 550	Gianto 95	1213 €
Zebra G95/1800 RAL	TC 002 402	Ø 1820 × h 450 × d 550	Gianto 95	913 €
Zebra G95/1900 Multicolor	TC 002 403	Ø 1900 × h 450 × d 550	Gianto 95	1213 €
Zebra G95/1900 RAL	TC 002 403	Ø 1900 × h 450 × d 550	Gianto 95	913 €

Available Colors

Multicolor 500 gloss



RAL 7004 RAL 9016 RAL 6034 RAL 5008 RAL 3027

Multicolor 501 mat



RAL 7016 RAL 5014 RAL 4001 RAL 3015 RAL 1004

RAL color¹



RAL 7016 Terra 036 RAL 7043 Terra 040 RAL 8019 Terra 038

¹ (smooth gloss coating, smooth mat coating, slightly rough texture mat, scabrous texture gloss)

Zebra G95/1800 Multicolor

Ø 1820 × h 450 × d 550 mm

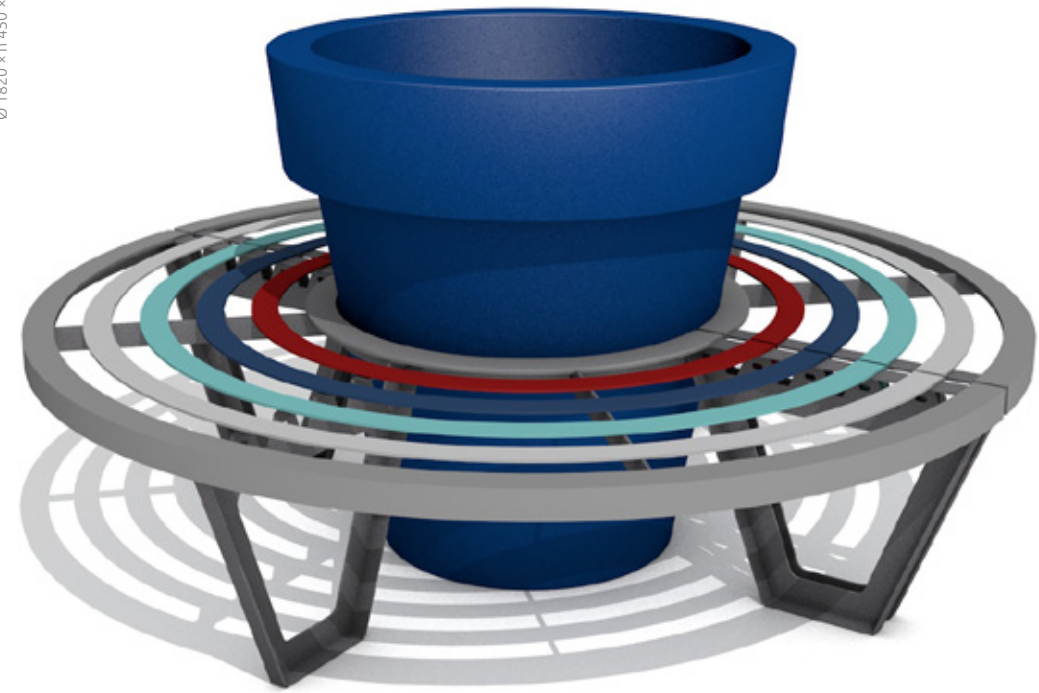

G95 option available: G95/1900 means a wider diameter of the bench each bench rung can have any color from the RAL palette compatible pot – Gianto 95 possibility of fixing to the ground

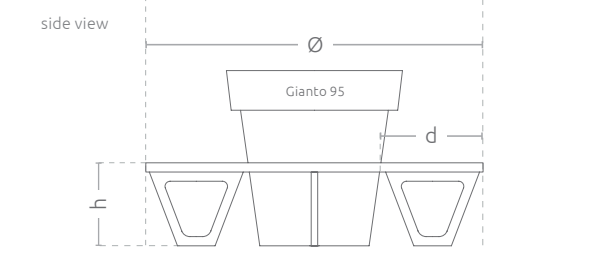
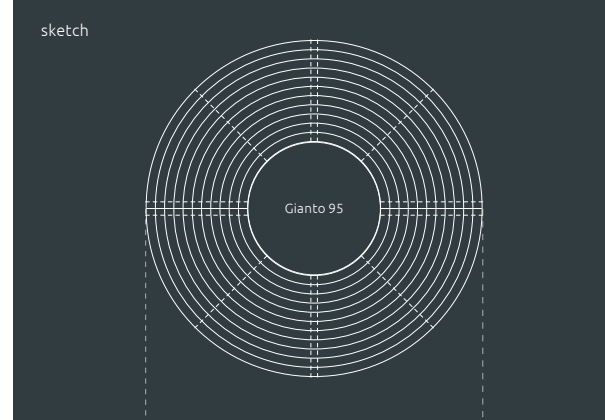

Round Bench Zebra 95 1/2

This city bench, compatible with Gianto 95, in a circular and semicircular shape, guarantees not only comfort of use but also an attractive visual effect. Solid materials used in the production process of the bench guarantee durability and reliability of the construction for long years, even in unfavorable weather conditions. Each bench rung can have any color.

Features



a wide range of colors



powder coating RAL



hot-dip galvanized steel



compatible with the Gianto pot



smooth or rough surface



fixings to the ground

Model	Code	Dimensions [mm]	Compatibility	Net Price
1/2 Zebra G95/1800 Multicolor	TC 002 303	Ø 1820 × r 910 × h 450 × d 550	Gianto 95	728 €
1/2 Zebra G95/1800 RAL	TC 002 303	Ø 1820 × r 910 × h 450 × d 550	Gianto 95	548 €
1/2 Zebra G95/1900 Multicolor	TC 002 305	Ø 1900 × r 950 × h 450 × d 550	Gianto 95	728 €
1/2 Zebra G95/1900 RAL	TC 002 305	Ø 1900 × r 950 × h 450 × d 550	Gianto 95	548 €

Available Colors



Multicolor 500 gloss



Multicolor 501 mat



RAL color¹

¹ (smooth gloss coating, smooth mat coating, slightly rough texture mat, scabrous texture gloss)

1/2 Zebra G95/1800 Multicolor

Ø 1820 × r 910 × h 450 × d 550 mm

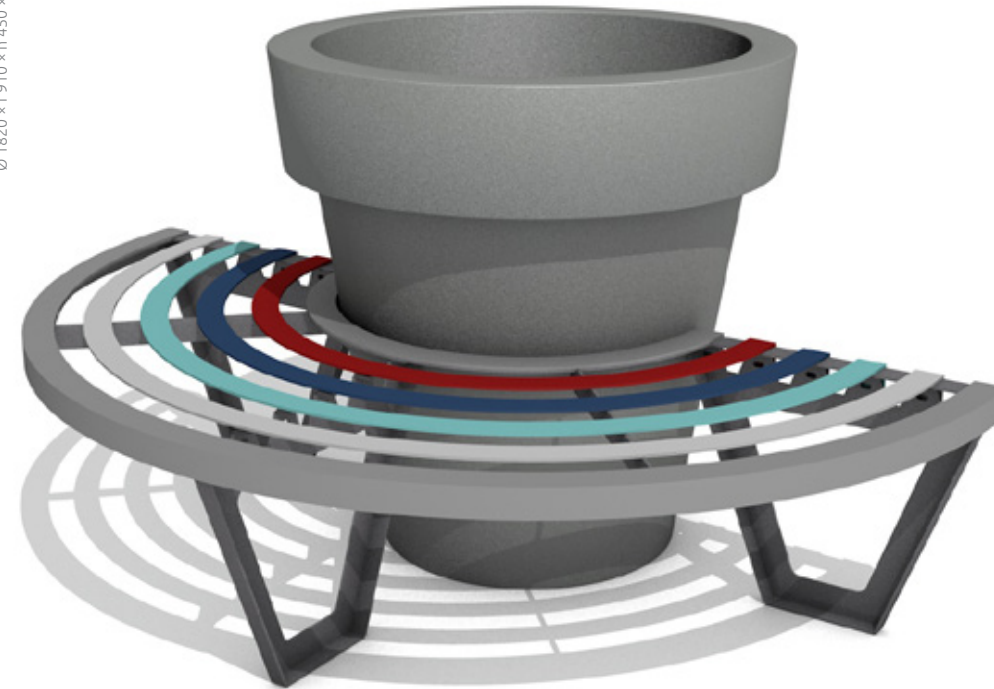

G95 1/2

option available: G951/1900 means a wider diameter of the bench each bench rung can have any color from the RAL palette compatible pot – Gianto 95

front view



sketch

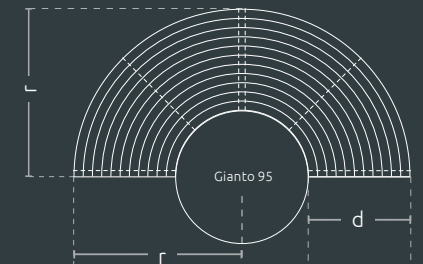



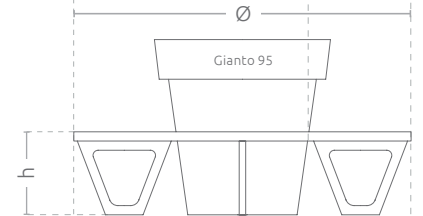



side view



Round Bench Zebra 120

This city bench designed to create a set with Gianto 120, in a circular and semicircular shape, guarantees not only high comfort of use but also an attractive visual effect. A steel bench and polyethylene used in the production process of the pot assure resistance, regardless of the weather conditions. Each bench rung can have any color.

Features

-  a wide range of colors
-  powder coating RAL
-  hot-dip galvanized steel
-  compatible with the Gianto pot
-  smooth or rough surface
-  fixings to the ground

Model	Code	Dimensions [mm]	Compatibility	Net Price
Zebra G120/2000 Multicolor	TC 002 404	Ø 2000 × h 450 × d 550	Gianto 120	1313 €
Zebra G120/2000 RAL	TC 002 404	Ø 2000 × h 450 × d 550	Gianto 120	988 €

Available Colors



RAL 7004
Multicolor 500 gloss



RAL 9016
Multicolor 500 gloss



RAL 6034
Multicolor 500 gloss



RAL 5008
Multicolor 500 gloss



RAL 3027
Multicolor 500 gloss



RAL 7016
Multicolor 501 mat



RAL 5014
Multicolor 501 mat



RAL 4001
Multicolor 501 mat

RAL 3015
Multicolor 501 mat

RAL 1004
Multicolor 501 mat

RAL 7016 Terra 036
RAL color 1



RAL 7043 Terra 040
RAL color 1

RAL 8019 Terra 038
RAL color 1

¹ (smooth gloss coating, smooth mat coating, slightly rough texture mat, scabrous texture gloss)

Zebra G120/2000 Multicolor

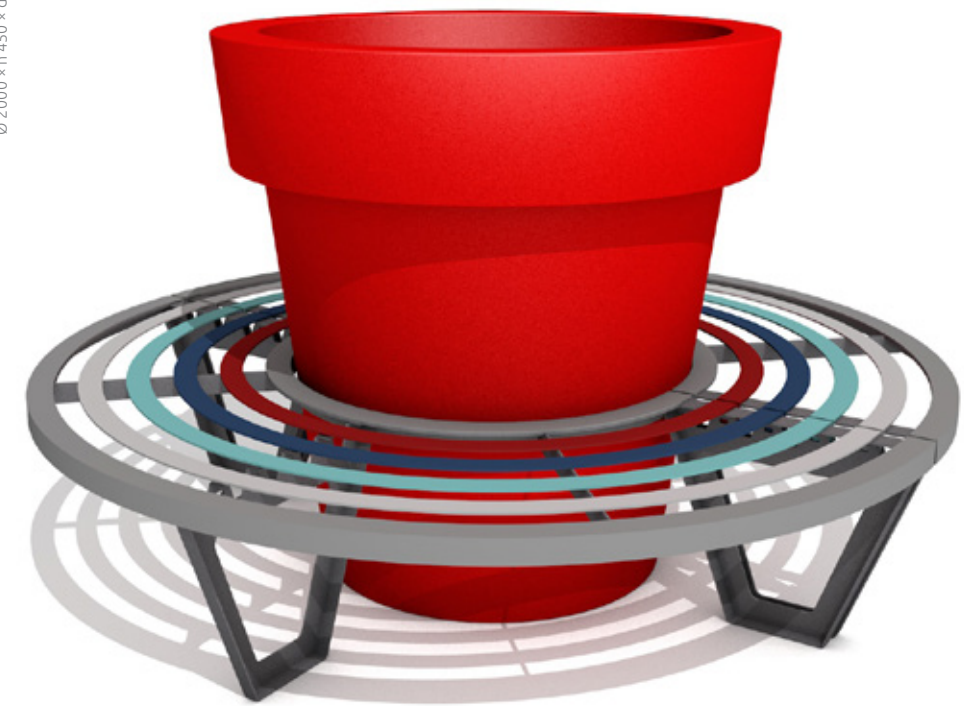
Ø 2000 × h 450 × d 550 mm





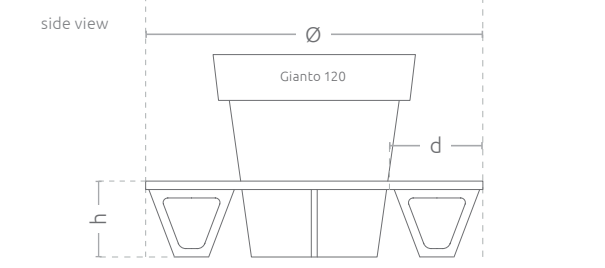
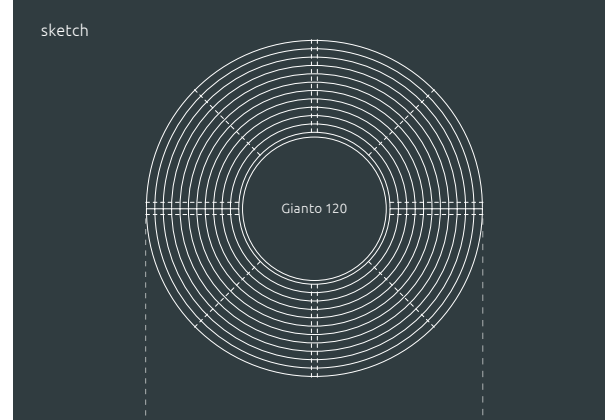



G120 each bench rung can have any color from the RAL palette compatible pot – Gianto 120 possibility of fixing to the ground



Round Bench Zebra 120 1/2













This city bench designed to create a set with Gianto 120, in a circular and semicircular shape, guarantees not only high comfort of use but also an attractive visual effect. A steel bench and polyethylene used in the production process of the pot assure resistance, regardless of the weather conditions. Each bench rung can have any color.

Features

-  a wide range of colors
-  powder coating RAL
-  hot-dip galvanized steel
-  compatible with the Gianto pot
-  smooth or rough surface
-  fixings to the ground

Model	Code	Dimensions [mm]	Compatibility	Net Price
1/2 Zebra G120/2000 Multicolor	TC 002 308	Ø 2000 × r 1000 × h 450 × d 550	Gianto 120	788 €
1/2 Zebra G120/2000 RAL	TC 002 308	Ø 2000 × r 1000 × h 450 × d 550	Gianto 120	593 €

Available Colors

												
RAL 7004	RAL 9016	RAL 6034	RAL 5008	RAL 3027	RAL 7016	RAL 5014	RAL 4001	RAL 3015	RAL 1004	RAL 7016 Terra 036	RAL 7043 Terra 040	RAL 8019 Terra 038

Multicolor 500 gloss
Multicolor 501 mat
RAL color¹

¹ (smooth gloss coating, smooth mat coating, slightly rough texture mat, scabrous texture gloss)

1/2 Zebra G120/2000 Multicolor

Ø 2000 × r 1000 × h 450 × d 550 mm

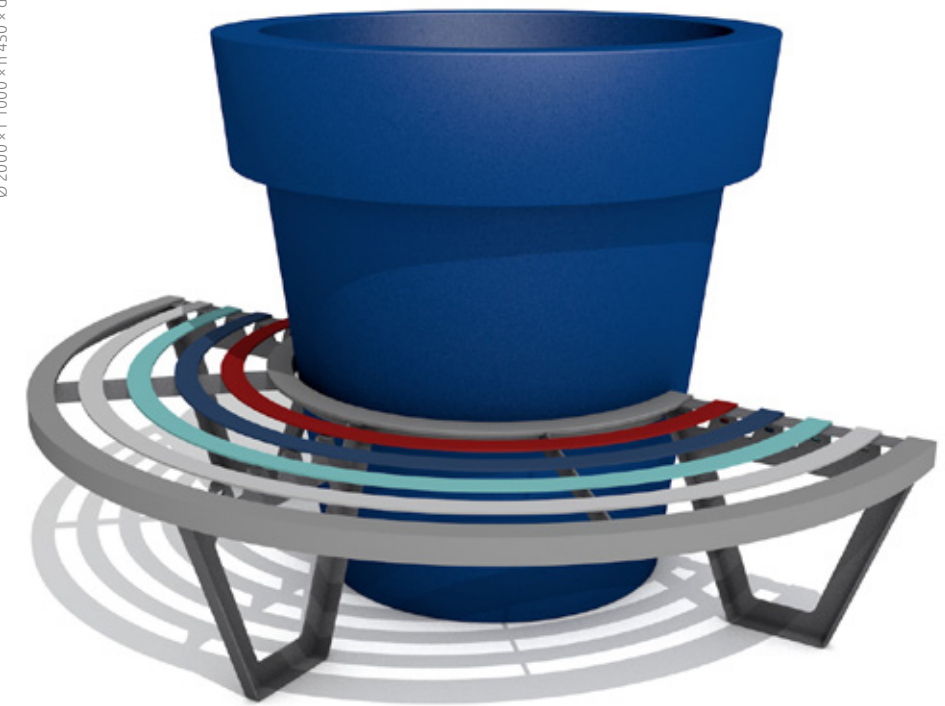

G120 1/2 each bench rung can have any color from the RAL palette compatible pot – Gianto 120

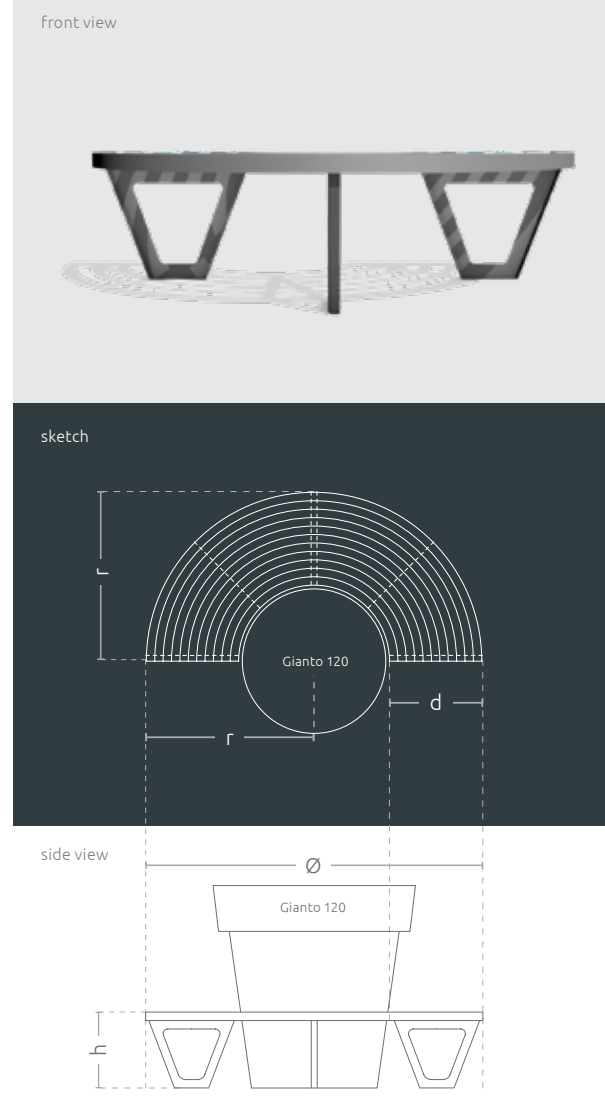







Bench with backrest Zebra













The city bench has a unique shape and color. Steel surface guarantees durability and resistance of the bench, regardless of the weather conditions. The bench is fixed with anchors, assuring resistance to mechanical damage. Each bench rung can have any color.

Features

-  a wide range of colors
-  powder coating RAL
-  hot-dip galvanized steel
-  fixings to the ground
-  smooth or rough surface

Model	Code	Dimensions [mm]	Net Price
Zebra Multicolor	TC 002 307	w 1650 x d 700 x h 900 x ds 440 x hs 440	688 €
Zebra RAL	TC 002 307	w 1650 x d 700 x h 900 x ds 440 x hs 440	488 €

Available Colors

												
RAL 7004	RAL 9016	RAL 6034	RAL 5008	RAL 3027	RAL 7016	RAL 5014	RAL 4001	RAL 3015	RAL 1004	RAL 7016 Terra 036	RAL 7043 Terra 040	RAL 8019 Terra 038
Multicolor 500 gloss					Multicolor 501 mat					RAL color ¹		

¹ (smooth gloss coating, smooth mat coating, slightly rough texture mat, scabrous texture gloss)

Zebra Multicolor

w 1650 x d 700 x h 900 x ds 440 x hs 440 mm



Mu each bench rung can have any color from the RAL palette ergonomic shape of the seat

front view

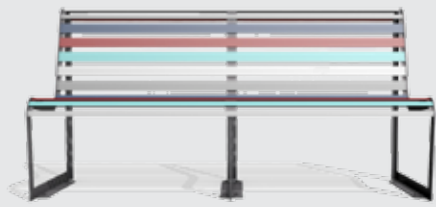

sketch

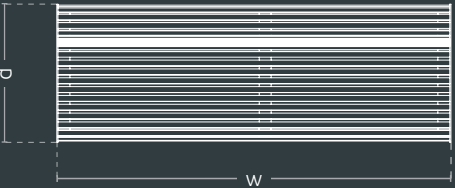



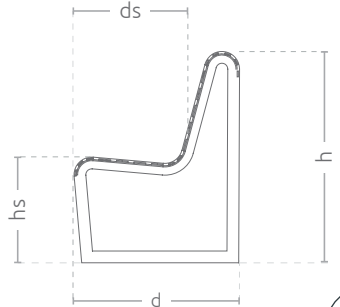

side view



Bench without backrest Zebra Basic













The city bench has a unique shape and color. Steel surface guarantees durability and resistance of the bench, regardless of the weather conditions. The bench is fixed with anchors, assuring resistance to mechanical damage. Each bench rung can have any color.

Features

-  a wide range of colors
-  powder coating RAL
-  hot-dip galvanized steel
-  fixings to the ground
-  smooth or rough surface

Model	Code	Dimensions [mm]	Net Price
Zebra Basic Multicolor Vertical	TC 002 306	w 1650 × h 440 × ds 580	613 €
Zebra Basic RAL Vertical	TC 002 306	w 1650 × h 440 × ds 580	538 €
Zebra Basic Multicolor Horizontal	TC 002 309	w 1650 × h 440 × ds 580	563 €
Zebra Basic RAL Horizontal	TC 002 309	w 1650 × h 440 × ds 580	413 €

Available Colors

												
RAL 7004	RAL 9016	RAL 6034	RAL 5008	RAL 3027	RAL 7016	RAL 5014	RAL 4001	RAL 3015	RAL 1004	RAL 7016 Terra 036	RAL 7043 Terra 040	RAL 8019 Terra 038

Multicolor 500 gloss Multicolor 501 mat RAL color¹

¹ (smooth gloss coating, smooth mat coating, slightly rough texture mat, scabrous texture gloss)

Zebra Basic Multicolor Vertical

w 1650 × h 440 × ds 580 mm

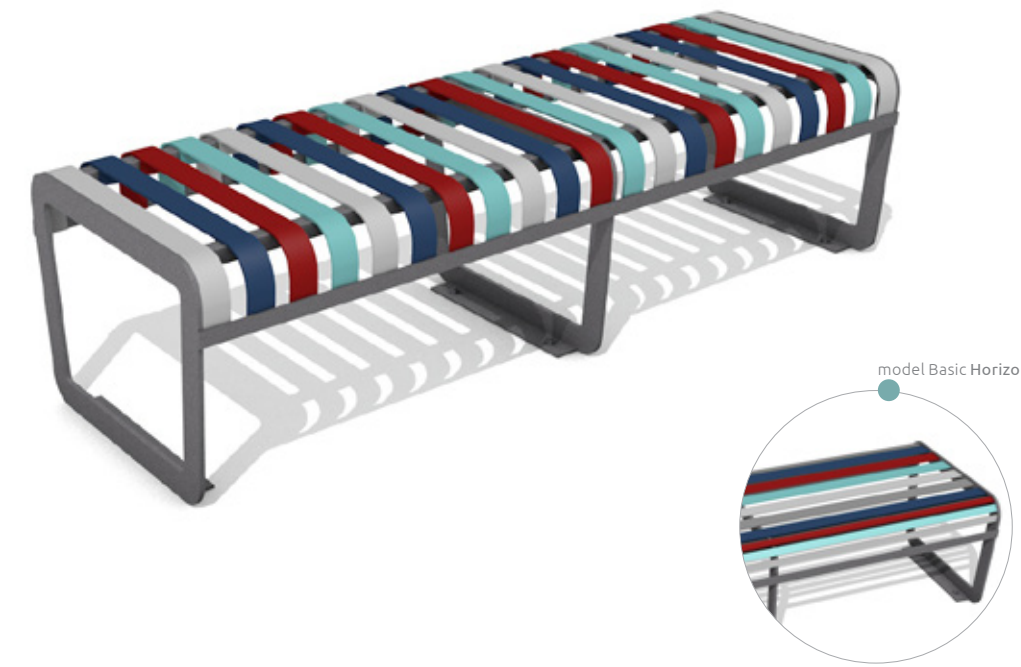

Ve each bench rung can have any color from the RAL palette
rungs spread: vertical or horizontal

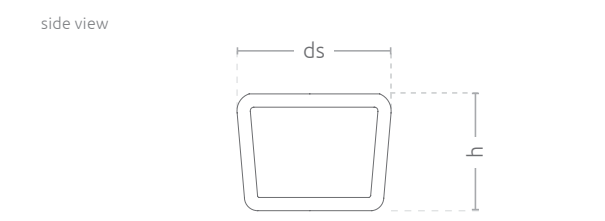
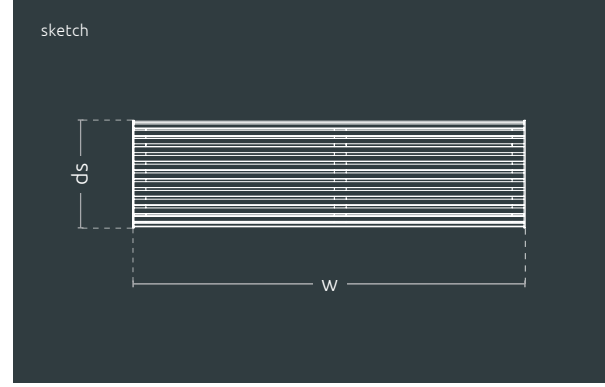



urbana

Furniture For Urban Jungle

Classical solutions on an urban scale. The Urbana Collection is a line of modular elements for public spaces. A bench, pot, tourist information stand or bicycle rack can be presented as individual elements, but also they can create a coherent composition in the space or become its main accent. Their high weight means that there is no need of fixing the furniture to the ground and the effect is immediate without any construction works. Steel used in the production process of the Urbana Collection guarantees that the decorations resist severe weather conditions but also acts of vandalism. They are solid, aesthetic and functional solutions for years.



Urban Pot Urbana L

A small flower pot made from steel. This model with the capacity of almost 200 liters provides the possibility of launching significant number of plants into the surroundings, even in the places without any natural substrate. A solid container can go with other elements of the collection.

Features

- compatible with the whole collection
- powder coating RAL
- frame - hot-dip galvanized steel
- walls - hot-dip galvanized steel
- smooth or rough surface
- reinforced bottom
- heavy and stable
- styrofoam insulation
- adjustable height
- culture tub

Model	Code	Dimensions [mm]	Capacity	Net Price
Urban Pot Urbana L	TC 001 101	w 1040 × h 700 × d 555	176 l	738 €

Available Colors

- RAL 7016 Terra 036
- RAL 7043 Terra 040
- RAL 8019 Terra 038

RAL color¹

Pot variants with a culture tub

Dimensions [mm]

w 1200
d 620
h 530



Personalized Model
(any pot size - according to your needs)

¹ (smooth gloss coating, smooth mat coating, slightly rough texture mat, scabrous texture gloss)

Urban Pot Urbana L

w 1040 × h 700 × d 555 mm



front view

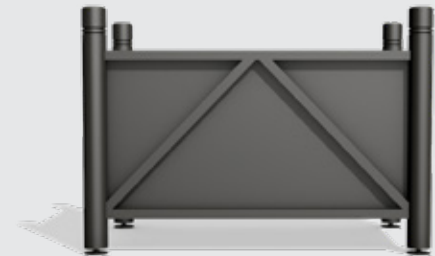

sketch

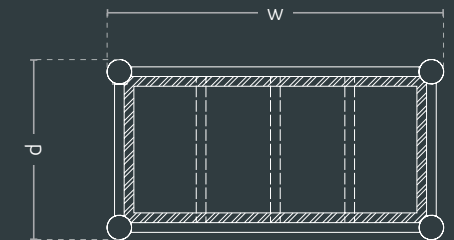

view

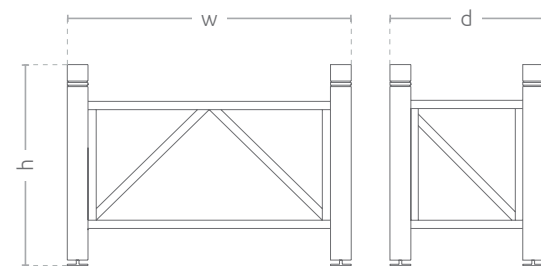

L stabilize the pot on the ground
each leg adjustment allows to get the perfect level

Urban Pot Urbana XL

A big pot made from steel. The largest model with the capacity of almost 700 liters allows to launch the maximum number of plants into the surroundings, even into places without natural substrate. A solid container can go together with other elements of the collection.

Features

- compatible with the whole collection
- powder coating RAL
- frame - hot-dip galvanized steel
- walls - hot-dip galvanized steel
- smooth or rough surface
- stabilizing holders to a tree
- reinforced bottom
- heavy and stable
- styrofoam insulation
- adjustable height
- culture tub

Model	Code	Dimensions [mm]	Capacity	Net Price
Urban Pot Urbana XL	TC 001 102	w 1040 × h 1145 × d 1040	684 l	1375 €

Available Colors

- RAL 7016 Terra 036
- RAL 7043 Terra 040
- RAL 8019 Terra 038

RAL color¹

Pot variants with a culture tub

Dimensions [mm]	A	B	C	D
w	690	780	1000	1250
d	690	780	1000	1250
h	600	700	890	1150



Personalized Model
(any pot size - according to your needs)

¹ (smooth gloss coating, smooth mat coating, slightly rough texture mat, scabrous texture gloss)

Urban Pot Urbana XL

w 1040 × h 1145 × d 1040 mm

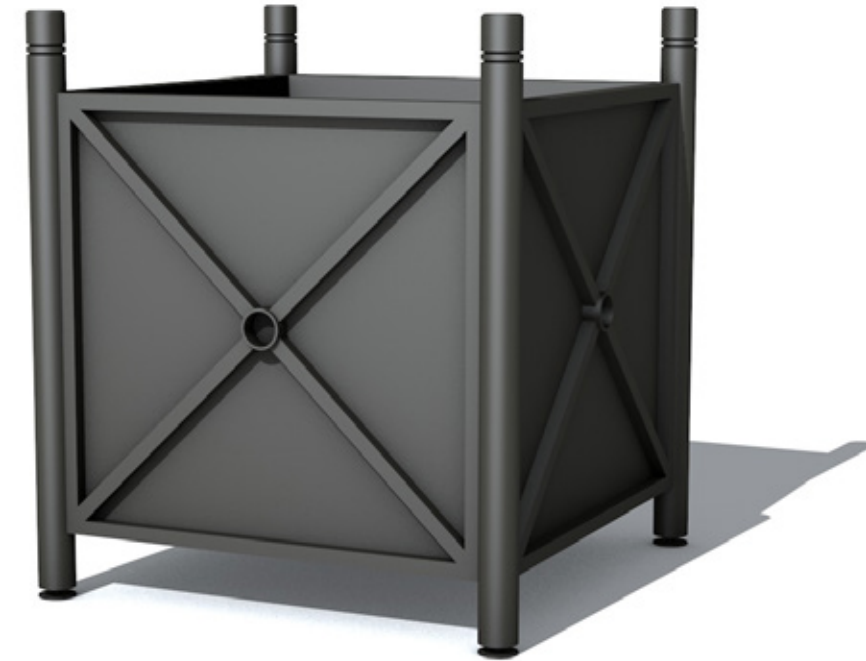

front view

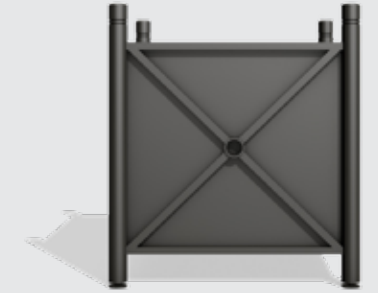

sketch

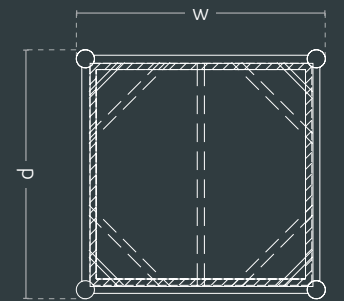

side view

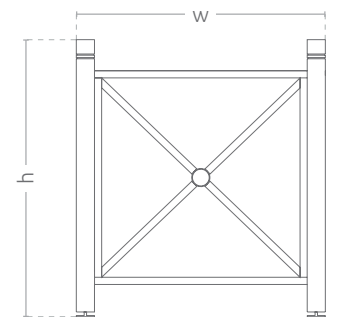

XL choose color which remains unchanged for years
powder coating guarantees that a color of the pot will not change under the influence of various weather conditions for long years

Bicycle Rank Urbana L

The steel bicycle rank is adjusted to the L pot. It was created in response to the growing trend of riding a bike. An additional function of the construction is an information stand with a map. Steel spans guarantee safe storage of the vehicles and resistance to mechanical damage.

Features

- compatible with the whole collection
- powder coating RAL
- frame - hot-dip galvanized steel
- walls - hot-dip galvanized steel
- smooth or rough surface
- reinforced bottom
- heavy and stable
- styrofoam insulation
- adjustable height
- culture tub

Model	Code	Dimensions [mm]	Capacity	Net Price
Bicycle Rank Urbana L	TC 001 502	w 1040 × hc 1695 × h 700 × d 855	176 l	813 €

Available Colors

- RAL 7016 Terra 036
- RAL 7043 Terra 040
- RAL 8019 Terra 038

RAL color¹

Pot variants with a culture tub

A

w 1200
d 920
hc 1695
h 530

Dimensions [mm]



Personalized Model
(any pot size - according to your needs)

w 1040 × hc 1695 × h 700 × d 855 mm

Bicycle Rank Urbana L



L a single decoration or an element of a bigger composition
a solid rank can be a single decoration and does not require additional installation or excavation

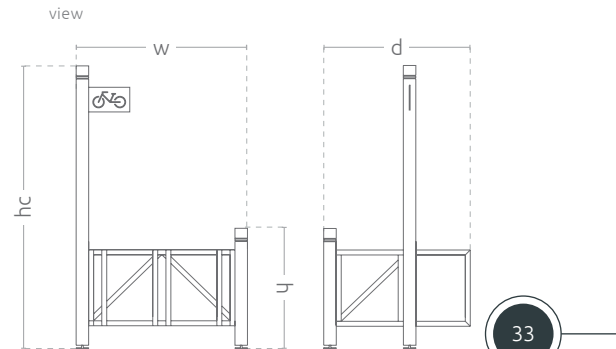
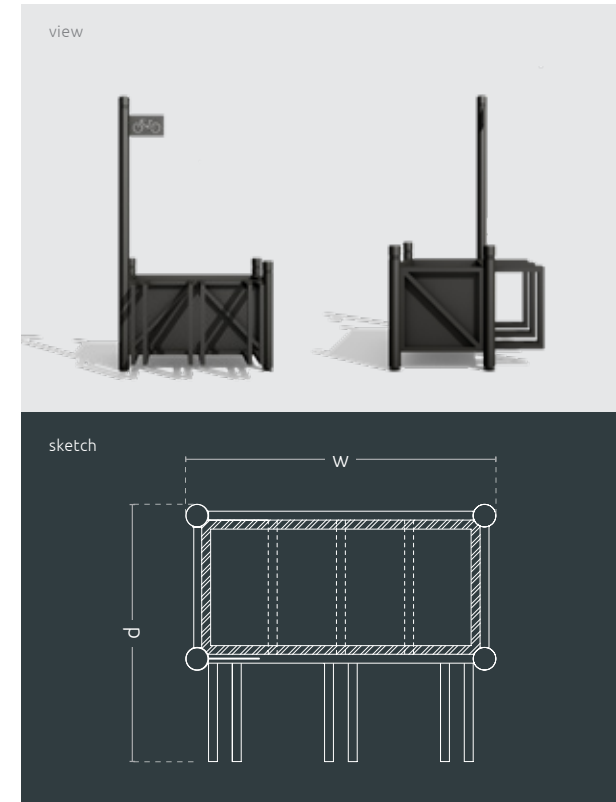

¹ (smooth gloss coating, smooth mat coating, slightly rough texture mat, scabrous texture gloss)

Bicycle Rank Urbana XL

The steel bicycle rank compatible with the XL pot. It was created in response to the growing trend of riding a bike. An additional function of the construction is an information stand with a map. Steel spans guarantee safe storage of the vehicles and resistance to mechanical damage.

Features

- compatible with the whole collection
- powder coating RAL
- frame - hot-dip galvanized steel
- walls - hot-dip galvanized steel
- smooth or rough surface
- stabilizing holders to a tree
- reinforced bottom
- heavy and stable
- styrofoam insulation
- adjustable height
- culture tub

Model	Code	Dimensions [mm]	Capacity	Net Price
Bicycle Rank Urbana XL	TC 001 501	w 1040 × hc 1695 × h 1145 × d 1340	684 l	1450 €

Available Colors

- RAL 7016 Terra 036
- RAL 7043 Terra 040
- RAL 8019 Terra 038

RAL color¹

Pot variants with a culture tub

A	B	C	D
w 690	w 780	w 1000	w 1250
d 990	d 1080	d 1300	d 1550
hc 1695	hc 1695	hc 1695	hc 1695
h 600	h 700	h 890	h 1150

Dimensions [mm]



Personalized Model
(any pot size - according to your needs)

¹ (smooth gloss coating, smooth mat coating, slightly rough texture mat, scabrous texture gloss)

Bicycle Rank Urbana XL

w 1040 × hc 1695 × h 1145 × d 1340 mm



XL safe storage of bikes
the wheel holders are made from heavy and stable steel which prevents their theft and damage

view



sketch

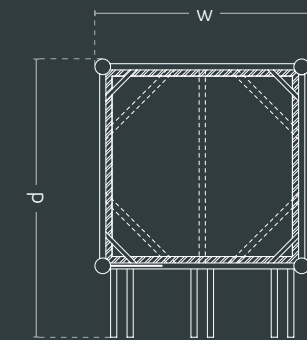

view

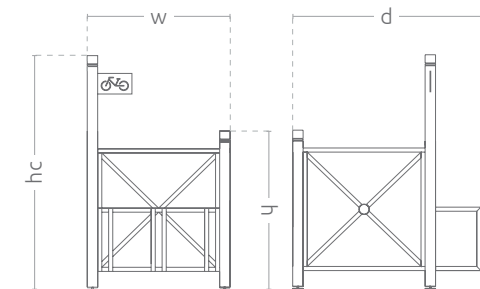

Tourist Information Stand Urbana L

A tourist information stand built on a solid, steel construction. It is an element of the collection thanks to which tourists and guests will be provided with required information: city maps, welcome leaflets or timetables of public transport. The product is compatible with the L pot, which allows to bring some additional plants to the surroundings.

Features

- compatible with the whole collection
- powder coating RAL
- frame - hot-dip galvanized steel
- walls - hot-dip galvanized steel
- smooth or rough surface
- reinforced bottom
- heavy and stable
- styrofoam insulation
- adjustable height
- culture tub

Model	Code	Dimensions [mm]	Capacity	Net Price
Tourist Information Stand Urbana L	TC 001 402	w 1040 × hc 1695 × h 700 × d 550	176 l	888 €

Available Colors

- RAL 7016 Terra 036
- RAL 7043 Terra 040
- RAL 8019 Terra 038

RAL color¹

Pot variants with a culture tub

A

w 1200
d 620
hc 1695
h 530

Dimensions [mm]



Personalized Model
(any pot size - according to your needs)

¹ (smooth gloss coating, smooth mat coating, slightly rough texture mat, scabrous texture gloss)

Tourist Information Stand Urbana L

w 1040 × hc 1695 × h 700 × d 550 mm



XL add graphic elements of the stand
an information board makes it easy to present consistent visual identification of the surroundings

view



sketch

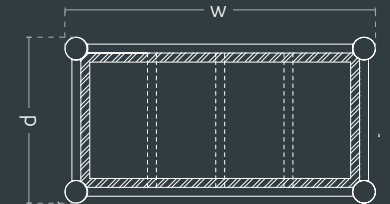

view

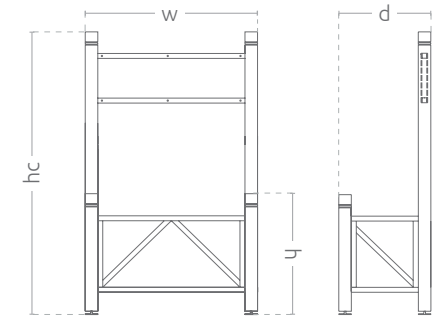

Tourist Information Stand Urbana XL

A tourist information stand built on a solid, steel construction. It is an element of the collection thanks to which tourists and guests will be provided with required information: city maps, welcome leaflets or timetables of public transport. The product is compatible with the XL pot, which allows to bring some additional plants to the surroundings.

Features

- compatible with the whole collection
- powder coating RAL
- frame - hot-dip galvanized steel
- walls - hot-dip galvanized steel
- smooth or rough surface
- stabilizing holders to a tree
- reinforced bottom
- heavy and stable
- styrofoam insulation
- adjustable height
- culture tub

Model	Code	Dimensions [mm]	Capacity	Net Price
Tourist Information Stand Urbana XL	TC 001 401	w 1040 × hc 1695 × h 1145 × d 1040	684 l	1525 €

Available Colors

- RAL 7016 Terra 036
- RAL 7043 Terra 040
- RAL 8019 Terra 038

RAL color¹

Pot variants with a culture tub

A	B	C	D
w 690	w 780	w 1000	w 1250
d 690	d 780	d 1000	d 1250
hc 1695	hc 1695	hc 1695	hc 1695
h 600	h 700	h 890	h 1150

Dimensions [mm]



Personalized Model
(any pot size - according to your needs)

Tourist Information Stand Urbana XL

w 1040 × hc 1695 × h 1145 × d 1040 mm

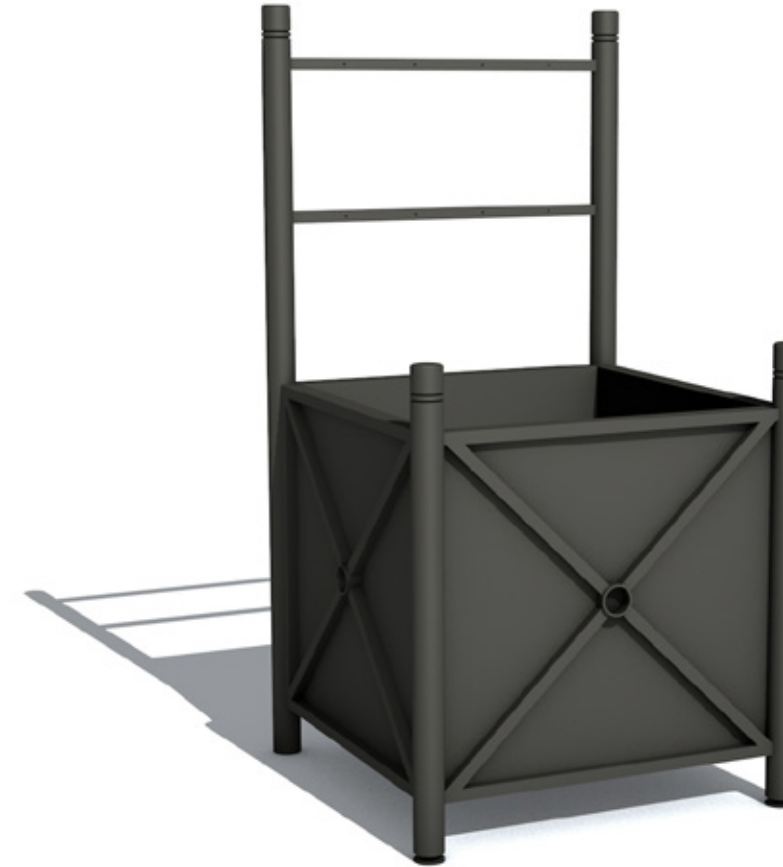

view



sketch

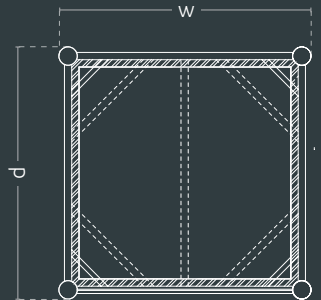

view

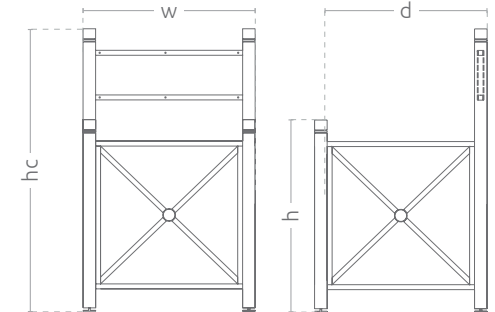

XL a place for planting really large plants
stabilizing brackets for the trees and larger decorative plants allow for efficient implementation of the greenery into the surrounding

¹ (smooth gloss coating, smooth mat coating, slightly rough texture mat, scabrous texture gloss)



CAMPO
S. ANZOLO
PARROCCHIA
S. ANZOLO

11111

Urban Pot Urbana 1/4

A steel pot in a 1/4 circle shape. This model allows to create various compositions, not only in corners but also on a circular concept. It provides an opportunity to launch into the surroundings a significant number of plants. The solid container can go with other elements of the collection.

Features

- powder coating RAL
- frame-hot-dip galvanized steel
- walls-hot-dip galvanized steel
- smooth or rough surface
- reinforced bottom
- heavy and stable
- styrofoam insulation
- adjustable height

Model	Code	Dimensions [mm]	Capacity	Net Price
Urban Pot Urbana 1/4	TC 001 103	wo 1180 × hc 700 × wi 830 × h 590 × d 410	176 l	575 €

Available Colors

- RAL 7016 Terra 036
- RAL 7043 Terra 040
- RAL 8019 Terra 038

RAL color¹

¹ (smooth gloss coating, smooth mat coating, slightly rough texture mat, scabrous texture gloss)



Personalized Model
(any pot size - according to your needs)

Urban Pot Urbana 1/4

wo 1180 × hc 700 × wi 830 × h 590 × d 410 mm

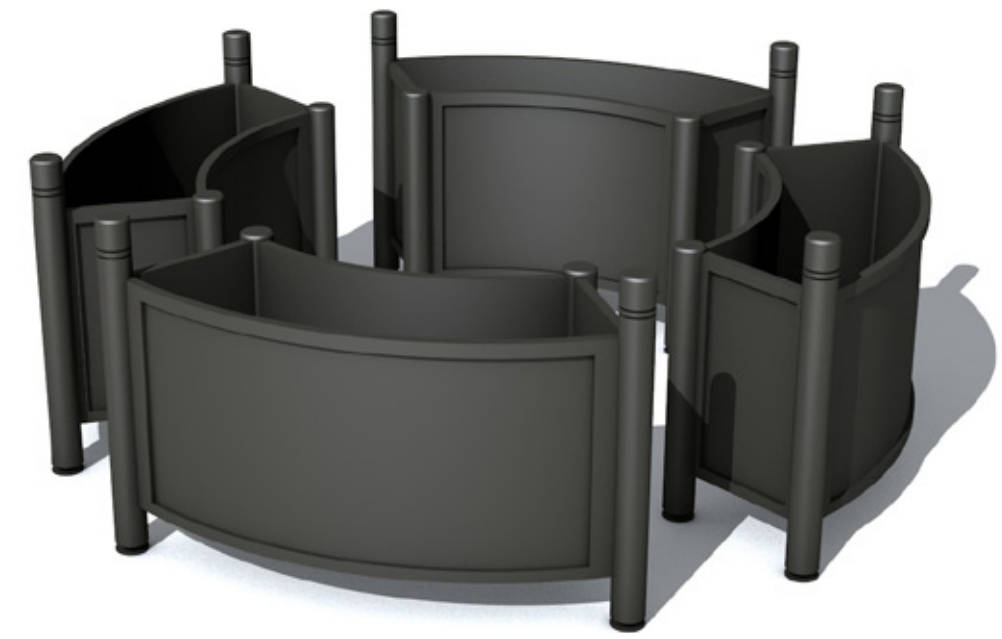

1/4 set of pots 1/4
the pot insulated with styrofoam – an insulation layer, which assures optimal conditions for plants

view

sketch

side view

Urban Bench Urbana L

An urban bench based on the steel elements with a seat made of synthetic wood. Steel, hot-dip galvanized legs are stylish but also resistant to the acts of vandalism. A solid seat guarantees comfortable rest.

Features

- compatible with the whole collection
- powder coating RAL
- hot-dip galvanized steel
- a fixing to the ground
- smooth or rough surface
- a bench seat made from composite board

Model	Code	Dimensions [mm]	Net Price
Urban Bench Urbana L	TC 001 302	w 1800 x h 450 x ds 430	275 €

Available Colors

- RAL 7016 Terra 036
- RAL 7043 Terra 040
- RAL 8019 Terra 038

RAL color¹

¹ (smooth gloss coating, smooth mat coating, slightly rough texture mat, scabrous texture gloss)



Personalized Model
(any pot size - according to your needs)

Urban Bench Urbana L

w 1800 x h 450 x ds 430 mm



L material of rungs – composite board compatible with the whole Urbana collection

front view



sketch

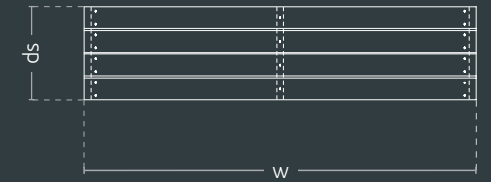

side view

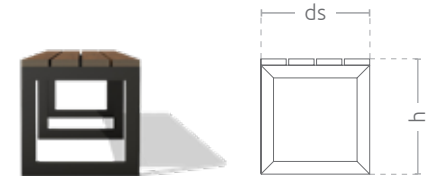

Urban Bench Urbana XL

An urban bench based on steel elements with a seat made of synthetic wood. Steel galvanized legs are stylish but also resistant to the acts of vandalism. This solid seat guarantees comfortable rest.

Features

- compatible with the whole collection
- powder coating RAL
- hot-dip galvanized steel
- a fixing to the ground
- smooth or rough surface
- a bench seat made from composite board

Model	Code	Dimensions [mm]	Net Price
Urban Bench Urbana XL	TC 001 301	w 1800 x h 945 x d 550 x hs 450 x ds 390	400 €

Available Colors

- RAL 7016 Terra 036
- RAL 7043 Terra 040
- RAL 8019 Terra 038

RAL color¹

¹ (smooth gloss coating, smooth mat coating, slightly rough texture mat, scabrous texture gloss)



Personalized Model
(any pot size - according to your needs)

Urban Bench Urbana XL



XL material of rungs – composite board compatible with the whole Urbana collection

front view



sketch

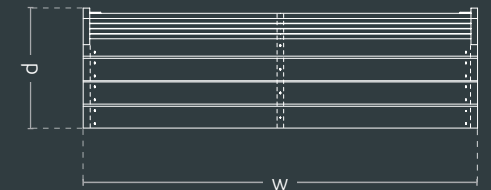

side view

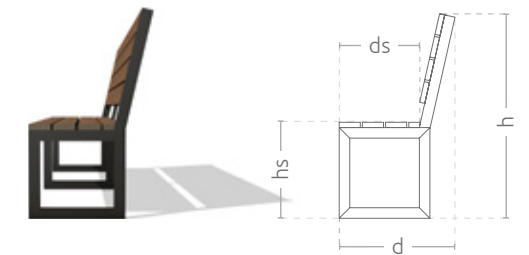



Railing Urbana L

A fully functional large railing, compatible with other urban furniture from the Urbana Collection. It is made from hot-dip galvanized steel, thus it is very durable and resistant to the acts of vandalism as well as changeable weather conditions. The product can be a part of some bigger composition, functioning as a fence, decoration or an element joining pots. The railing cannot remain an individual element without any pot or bench.

Features

-  compatible with the whole collection
-  powder coating RAL
-  hot-dip galvanized steel
-  smooth or rough surface
-  adjustable height

Model	Code	Dimensions [mm]	Net Price
Railing Urbana L	TC 001 201	w 1400 × h 1145 × d 72	163 €

- Available Colors
-  RAL 7016 Terra 036
 -  RAL 7043 Terra 040
 -  RAL 8019 Terra 038
- RAL color¹

¹ (smooth gloss coating, smooth mat coating, slightly rough texture mat, scabrous texture gloss)



Personalized Model
(any pot size - according to your needs)

Railing Urbana L

w 1400 × h 1145 × d 72 mm



front view

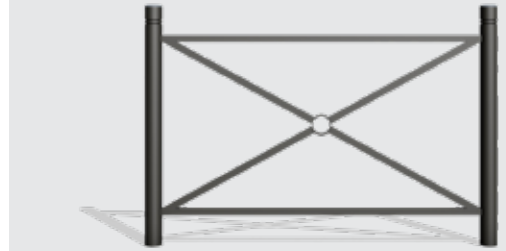

front view

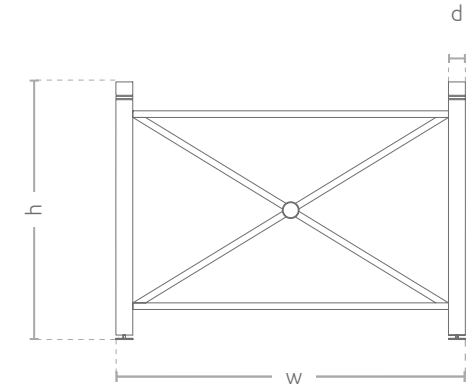

L create any arrangement with a bench or an urban pot compatible with the whole Urbana collection

Railing Urbana XL

A fully functional large railing, compatible with other urban furniture from the Urbana Collection. It is made from hot-dip galvanized steel, thus it is very durable and resistant to the acts of vandalism as well as changeable weather conditions. The product can be a part of some bigger composition, functioning as a fence, decoration or an element joining pots. The railing cannot remain an individual element without any pot or bench.

Features

- compatible with the whole collection
- powder coating RAL
- hot-dip galvanized steel
- smooth or rough surface
- adjustable height

Model	Code	Dimensions [mm]	Net Price
Railing Urbana XL	TC 001 202	w 2800 × h 1145 × d 72	275 €

Available Colors

- RAL 7016 Terra 036
- RAL 7043 Terra 040
- RAL 8019 Terra 038

RAL color¹

¹ (smooth gloss coating, smooth mat coating, slightly rough texture mat, scabrous texture gloss)



Personalized Model
(any pot size - according to your needs)

Railing Urbana XL

w 2800 × h 1145 × d 72 mm

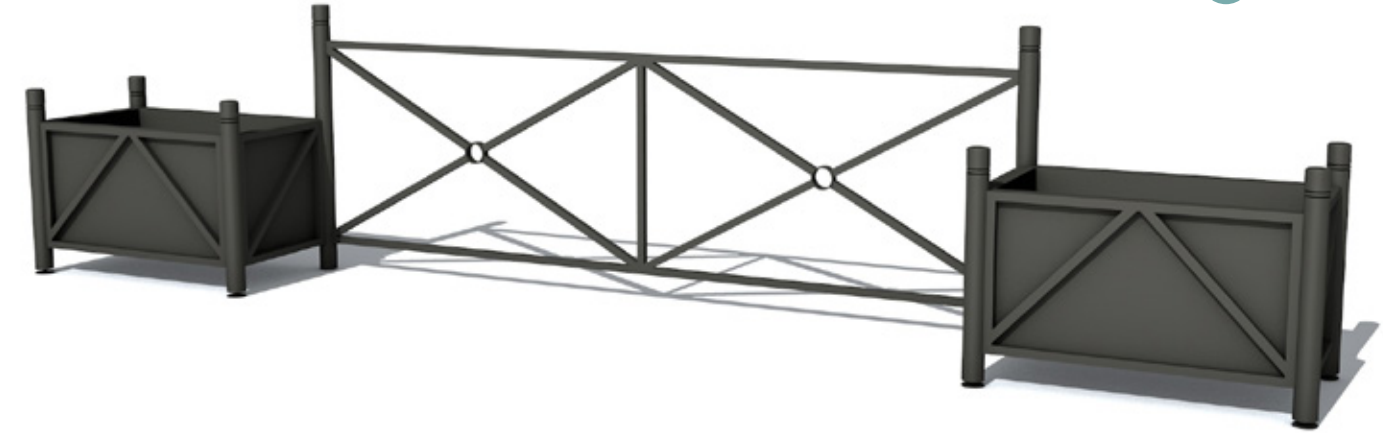

XL create any arrangement with a bench or an urban pot compatible with the whole Urbana collection

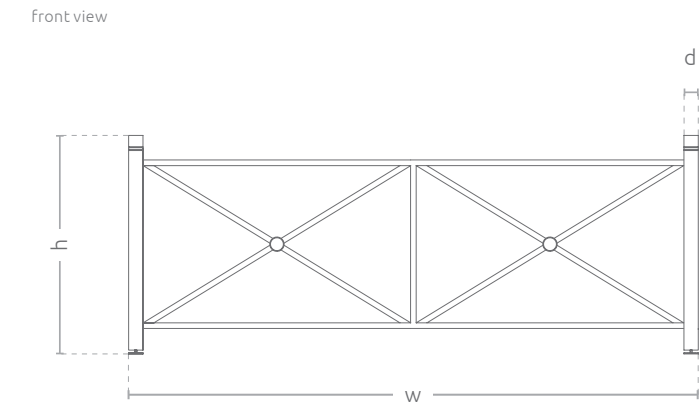
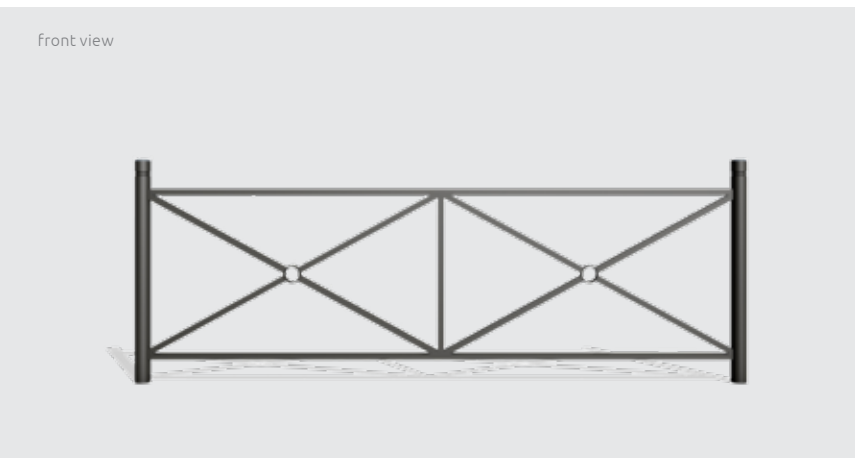



combine any elements +
**CREATE
YOUR
ARRANGEMENT**

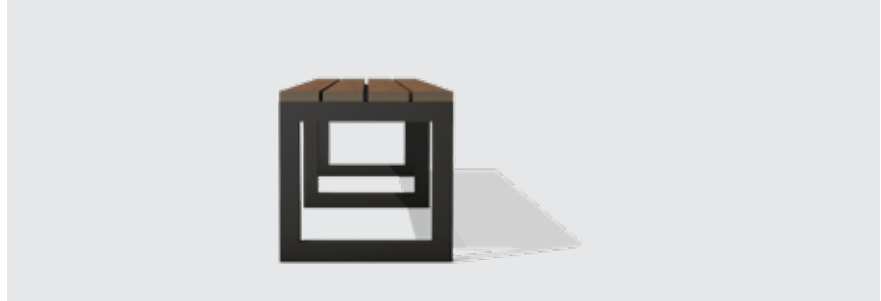

we suggest several options

the length of the set: approx. 5300 mm / the width of the set: approx. 1040 mm



Tourist Information Stand Urbana L

Railing Urbana L

Urban Pot Urbana XL

Urban Bench Urbana XL

THE SET PRICE:
2 650 €

the length of the set: approx. 2300 mm / the width of the set: approx. 1470 mm



the length of the set: approx. 5180 mm / the width of the set: approx. 1040 mm





wave

Nature and functionality

Nature and functionality – these are the elements from which the collection of urban furniture WAVE arise from. A consistent effect assure the Gianto pot, with its classical form and vivid colors, as well as unique seats with their colorful finish. The WAVE collection has a number of advantages – any combination of colors, container sizes and bench sizes allow to adapt the furniture to any space: from the main square to the kindergarten playground. A simple combination of each seat module provides next options of arrangement. Solid steel and resistant polyethylene guarantee the use for many years without any problems.



Quarter Bench For Gianto

A quarter bench is compatible with a Gianto pot. This carefully formed seat with a round shape, assures aesthetic visual effect and comfort of use. The steel surface of the bench and polyethylene used in a pot, guarantee that its form will remain unchanged for years, regardless of the weather conditions.

Features

- compatible with the whole collection
- powder coating RAL
- a hot-dip galvanized base
- a seat covered with zinc undercoat
- a fixing to the ground
- smooth or rough surface
- compatible with a Gianto pot

Model	Code	Dimensions [mm]	Compatibility	Net Price
1/4 80	TC 003 401	h 450 x d 555 x w 870	Gianto 80	263 €
1/4 95	TC 003 402	h 450 x d 555 x w 935	Gianto 95	288 €
1/4 120	TC 003 403	h 450 x d 555 x w 1000	Gianto 120	438 €

Available Colors

- RAL 7016 Terra 036
- RAL 7043 Terra 040
- RAL 8019 Terra 038

RAL color¹

¹ (smooth gloss coating, smooth mat coating, slightly rough texture mat, scabrous texture gloss)

1/4 95

h 450 x d 555 x w 935 mm



1/4 combine any elements - create sets Wave a compatible pot - Gianto 95

view



sketch

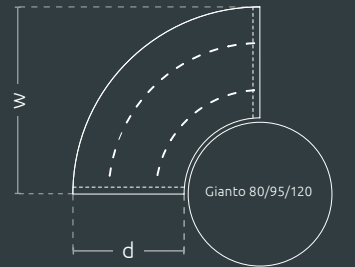

side view

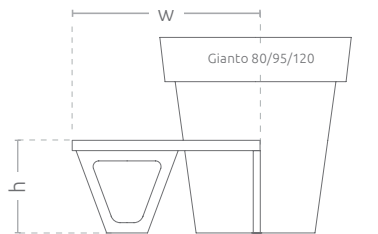

Half Bench For Gianto

This half bench is compatible with a Gianto pot. A carefully formed seat with a round shape, assures an aesthetic visual effect and comfort of use. The steel surface of the bench and polyethylene used in a pot, guarantee that its form will remain unchanged for years, regardless of the weather conditions.

Features

- compatible with the whole collection
- powder coating RAL
- a hot-dip galvanized base
- a seat covered with zinc undercoat
- a fixing to the ground
- smooth or rough surface
- compatible with a Gianto pot

Model	Code	Dimensions [mm]	Compatibility	Net Price
M80	TC 003 302	Ø 1740 × r 870 × h 450 × d 555	Gianto 80	485 €
M95	TC 003 301	Ø 1870 × r 935 × h 450 × d 555	Gianto 95	530 €
M120	TC 003 303	Ø 2000 × r 1000 × h 450 × d 555	Gianto 120	788 €

Available Colors

- RAL 7016 Terra 036
- RAL 7043 Terra 040
- RAL 8019 Terra 038

RAL color¹

¹ (smooth gloss coating, smooth mat coating, slightly rough texture mat, scabrous texture gloss)

M95

Ø 1870 × r 935 × h 450 × d 555 mm

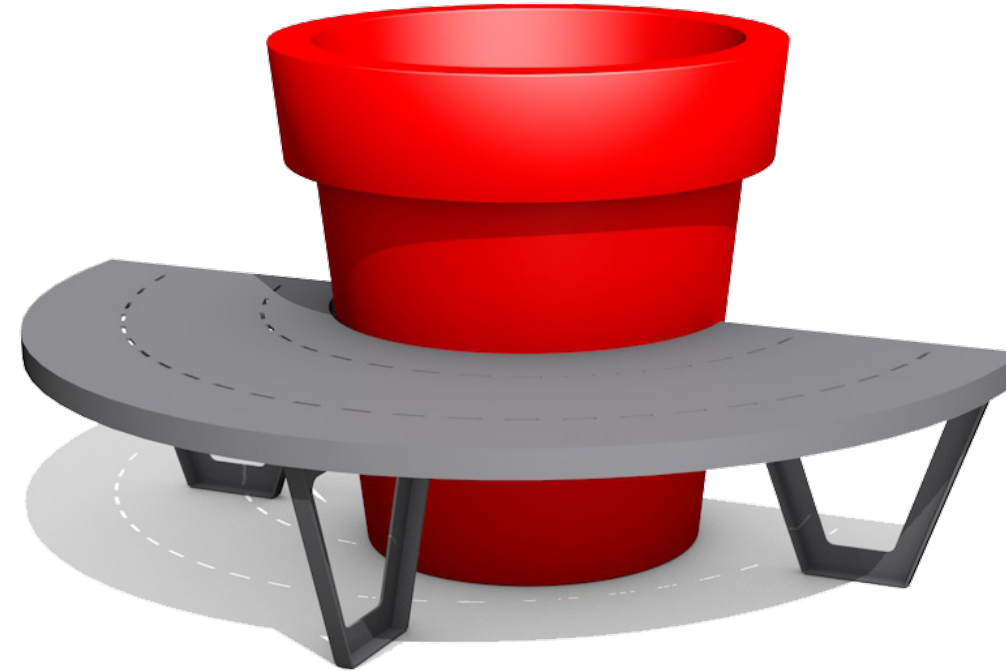

M80 M80 model has a narrower bench diameter a compatible pot – Gianto 80

front view



sketch

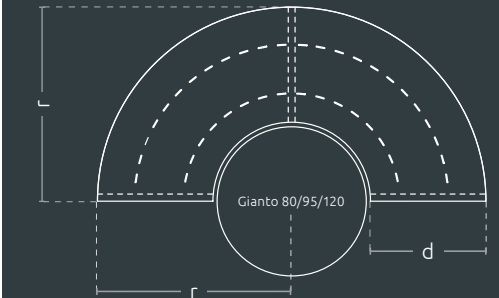

front view

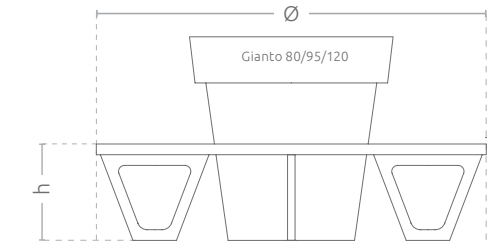

Pointed Bench For Gianto

This urban bench is compatible with a Gianto pot. A carefully formed seat with a semi-circular shape, assures an aesthetic visual effect and comfort of use. The steel surface of the bench and polyethylene used in a pot, guarantee that its form will remain unchanged for years, regardless of the weather conditions.

Features

- compatible with the whole collection
- powder coating RAL
- a hot-dip galvanized base
- a seat covered with zinc undercoat
- a fixing to the ground
- smooth or rough surface
- compatible with a Gianto pot

Model	Code	Dimensions [mm]	Compatibility	Net Price
Pointed Bench Right-Handed S80P	TC 003 703	w 980 × y 555 × h 450 × d 555	Gianto 80	175 €
Pointed Bench Left-Handed S80L	TC 003 704	w 980 × y 555 × h 450 × d 555	Gianto 80	175 €
Pointed Bench Right-Handed S95P	TC 003 701	w 1010 × y 575 × h 450 × d 555	Gianto 95	195 €
Pointed Bench Left-Handed S95L	TC 003 702	w 1010 × y 575 × h 450 × d 555	Gianto 95	195 €
Pointed Bench Right-Handed S120P	TC 003 705	w 1225 × y 730 × h 450 × d 555	Gianto 120	238 €
Pointed Bench Left-Handed S120L	TC 003 706	w 1225 × y 730 × h 450 × d 555	Gianto 120	238 €

Available Colors

- RAL 7016 Terra 036
- RAL 7043 Terra 040
- RAL 8019 Terra 038

RAL color ¹

¹ (smooth gloss coating, smooth mat coating, slightly rough texture mat, scabrous texture gloss)

Pointed Bench For Gianto S80P i S80L

w 980 × y 555 × h 450 × d 555 mm



view



sketch

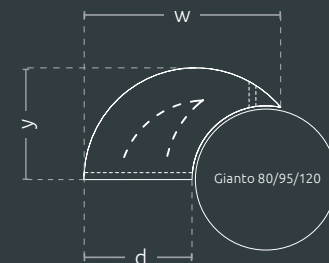

side view

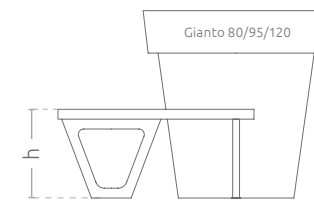

S95 right-handed and left-handed S95 models have a wider diameter a compatible pot – Gianto 95

Solo Set For Gianto

A set of urban furniture which consists of two steel benches in various shapes. The set is compatible with Gianto pots, which together create an original and comfortable composition.

Features

- compatible with the whole collection
- powder coating RAL
- a hot-dip galvanized base
- a seat covered with zinc undercoat
- a fixing to the ground
- smooth or rough surface
- compatible with a Gianto pot

Model	Code	Dimensions [mm]	Compatibility	Net Price
Solo Set (S80L + M80)	TC 003 801	Ø 1740 x w 1425 x h 450	Gianto 80	660 €
Solo Set (S95L + M95)	TC 003 802	Ø 1870 x w 1510 x h 450	Gianto 95	725 €
Solo Set (S120L + M120)	TC 003 808	Ø 2000 x w 1730 x h 450	Gianto 120	1 025 €

Available Colors

- RAL 7016 Terra 036
- RAL 7043 Terra 040
- RAL 8019 Terra 038

RAL color¹

¹ (smooth gloss coating, smooth mat coating, slightly rough texture mat, scabrous texture gloss)

Solo Set (S80L + M80)

Ø 1740 x w 1425 x h 450 mm

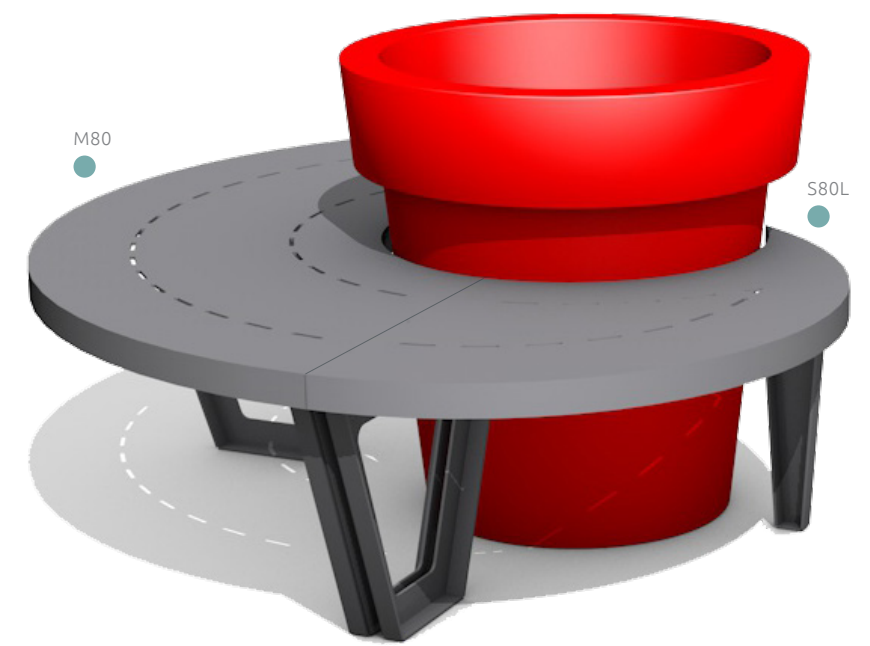

SO LO solo Set of Models: S95L + M SO 95 a compatible pot – Gianto 95

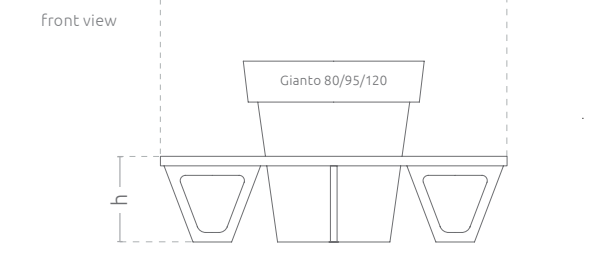
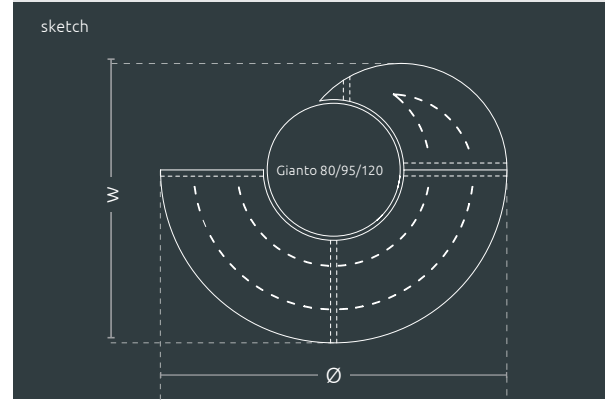

Doble Set For Gianto

A set of urban furniture which consists of four steel benches in various shapes. The benches are compatible with Gianto pots, which together create an original and comfortable composition.

Features

- compatible with the whole collection
- powder coating RAL
- a hot-dip galvanized base
- a seat covered with zinc undercoat
- a fixing to the ground
- smooth or rough surface
- compatible with a Gianto pot

Model	Code	Dimensions [mm]	Compatibility	Net Price
Doble Set (S95L + M95 + M80 + S80L)	TC 003 803	w 1805 x l 3055	Gianto 80, 95	1 385 €

Available Colors

- RAL 7016 Terra 036
- RAL 7043 Terra 040
- RAL 8019 Terra 038

RAL color¹

¹ (smooth gloss coating, smooth mat coating, slightly rough texture mat, scabrous texture gloss)

Doble Set (S95L + M95 + M80 + S80L)

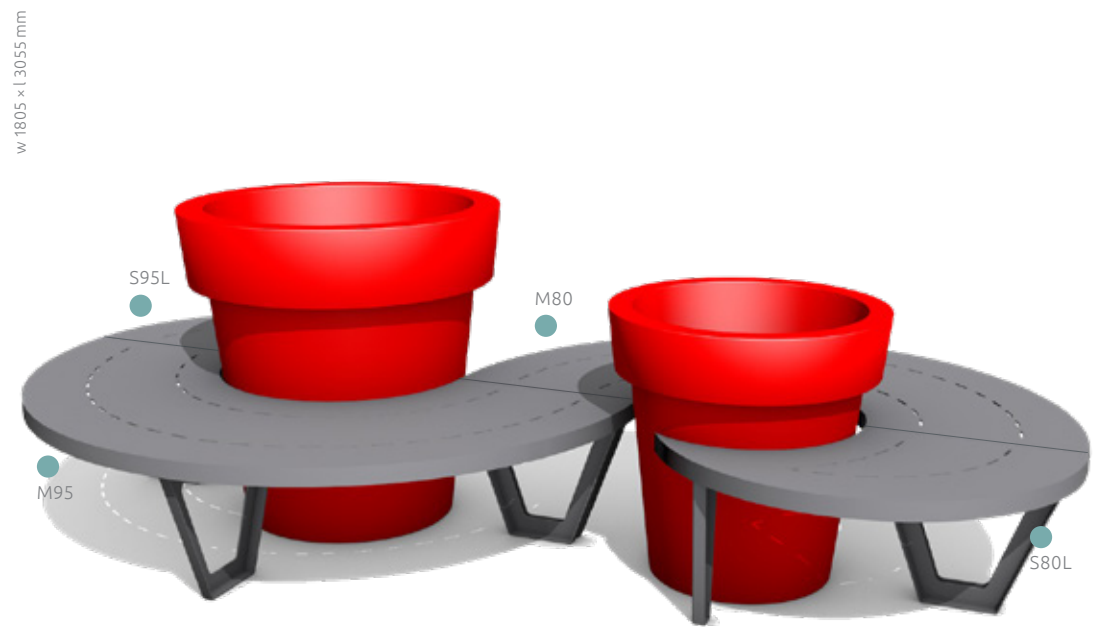

DOBLE a compatible pot – Gianto 80 i 95

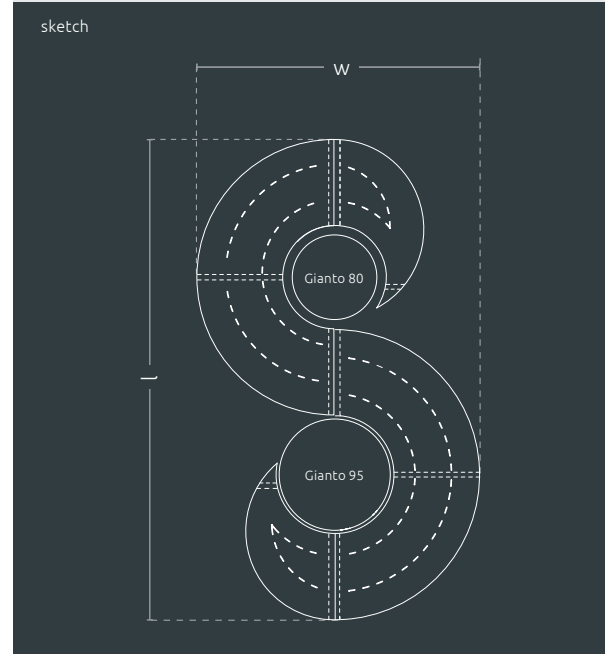

Triple Set For Gianto

A set of urban furniture which consists of five steel benches in various shapes. The benches are compatible with Gianto pots, which together create an original and comfortable composition.

Features

- compatible with the whole collection
- powder coating RAL
- a hot-dip galvanized base
- a seat covered with zinc undercoat
- a fixing to the ground
- smooth or rough surface
- compatible with a Gianto pot

Model	Code	Dimensions [mm]	Compatibility	Net Price
Triple Set (S95L + M95 + M80 + M95 + S95P)	TC 003 804	w 1805 x l 4370	Gianto 80, 95	1 935 €
Triple Set (S95L + M95 + M80 + M80 + S80P)	TC 003 805	w 1805 x l 4240	Gianto 80, 95	1 870 €

Available Colors

- RAL 7016 Terra 036
- RAL 7043 Terra 040
- RAL 8019 Terra 038

RAL color¹

¹ (smooth gloss coating, smooth mat coating, slightly rough texture mat, scabrous texture gloss)

Triple Set (S95L + M95 + M80 + M80 + S80P)

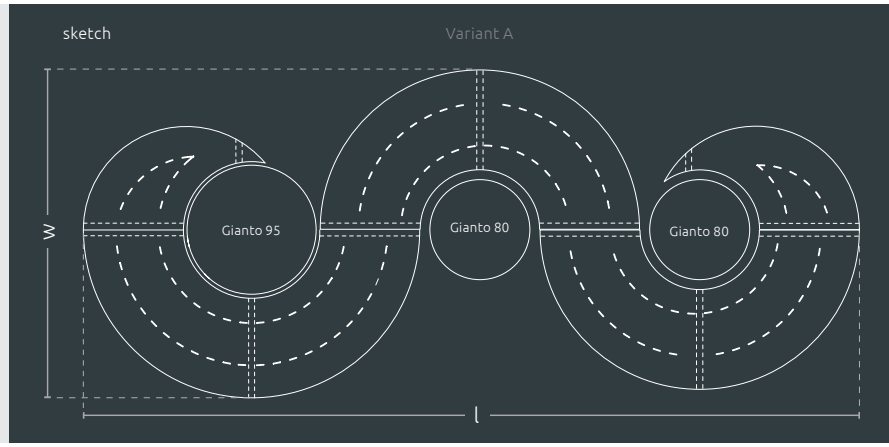
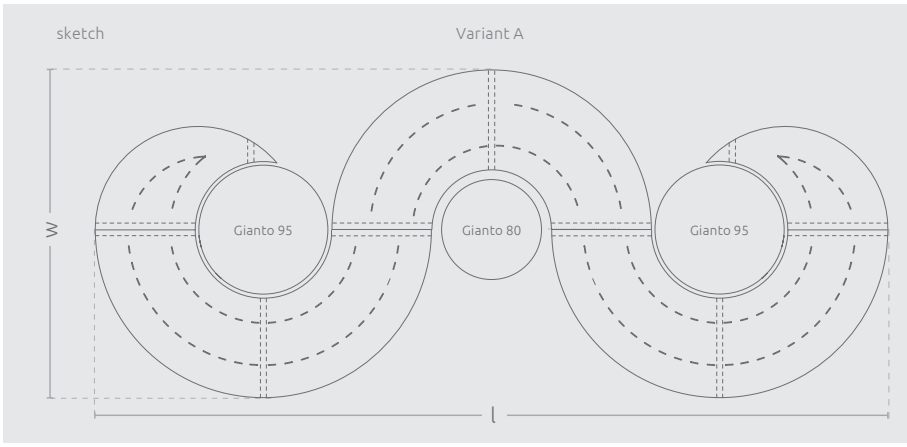

Tri Set For Gianto

A set of urban furniture which consists of three steel benches with round shapes. The benches are compatible with two or three Gianto pots, which can be planted with any plants. The composition is stable thanks to the fixing to the ground.

Features

- compatible with the whole collection
- powder coating RAL
- a hot-dip galvanized base
- a seat covered with zinc undercoat
- a fixing to the ground
- smooth or rough surface
- compatible with a Gianto pot

Model	Code	Dimensions [mm]	Compatibility	Net Price
Tri Set (S95L + M95 + 1/4 95 + 1/4 80 + S80P)	TC 003 806	w 3120 x l 2760	Gianto 80, 95	1 450 €

Available Colors

- RAL 7016 Terra 036
- RAL 7043 Terra 040
- RAL 8019 Terra 038

RAL color¹

¹ (smooth gloss coating, smooth mat coating, slightly rough texture mat, scabrous texture gloss)

Tri Set (S95L + M95 + 1/4 95 + 1/4 80 + S80P)



TRI combine with two or three pots a compatible pot – Gianto 80 i 95

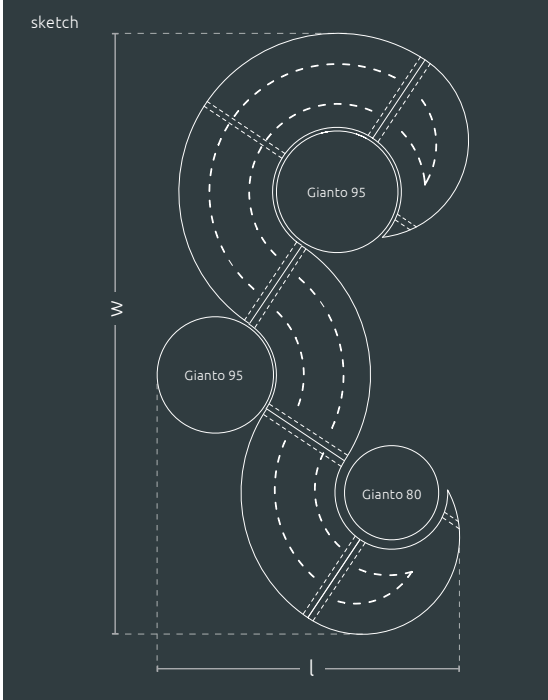

Quintus Set For Gianto

A set of urban furniture which consists of five joint steel benches in a rounded form. The set can be diversified by adding up to five Gianto pots. Powder coating guarantees that the bench will remain in an unchanged condition for many years, regardless of the weather conditions.

Features

- compatible with the whole collection
- powder coating RAL
- a hot-dip galvanized base
- a seat covered with zinc undercoat
- a fixing to the ground
- smooth or rough surface
- compatible with a Gianto pot

Model	Code	Dimensions [mm]	Compatibility	Net Price
Quintus Set (S95L + 1/4 95 + 1/4 80 + M80 + 1/4 80 + 1/4 95 + S95P)	TC 003 807	w 4300 x l 2760	Gianto 80, 95	1 975 €

Available Colors

- RAL 7016 Terra 036
- RAL 7043 Terra 040
- RAL 8019 Terra 038

RAL color¹

¹ (smooth gloss coating, smooth mat coating, slightly rough texture mat, scabrous texture gloss)

Quintus Set (S95L + 1/4 95 + 1/4 80 + M80 + 1/4 80 + 1/4 95 + S95P)

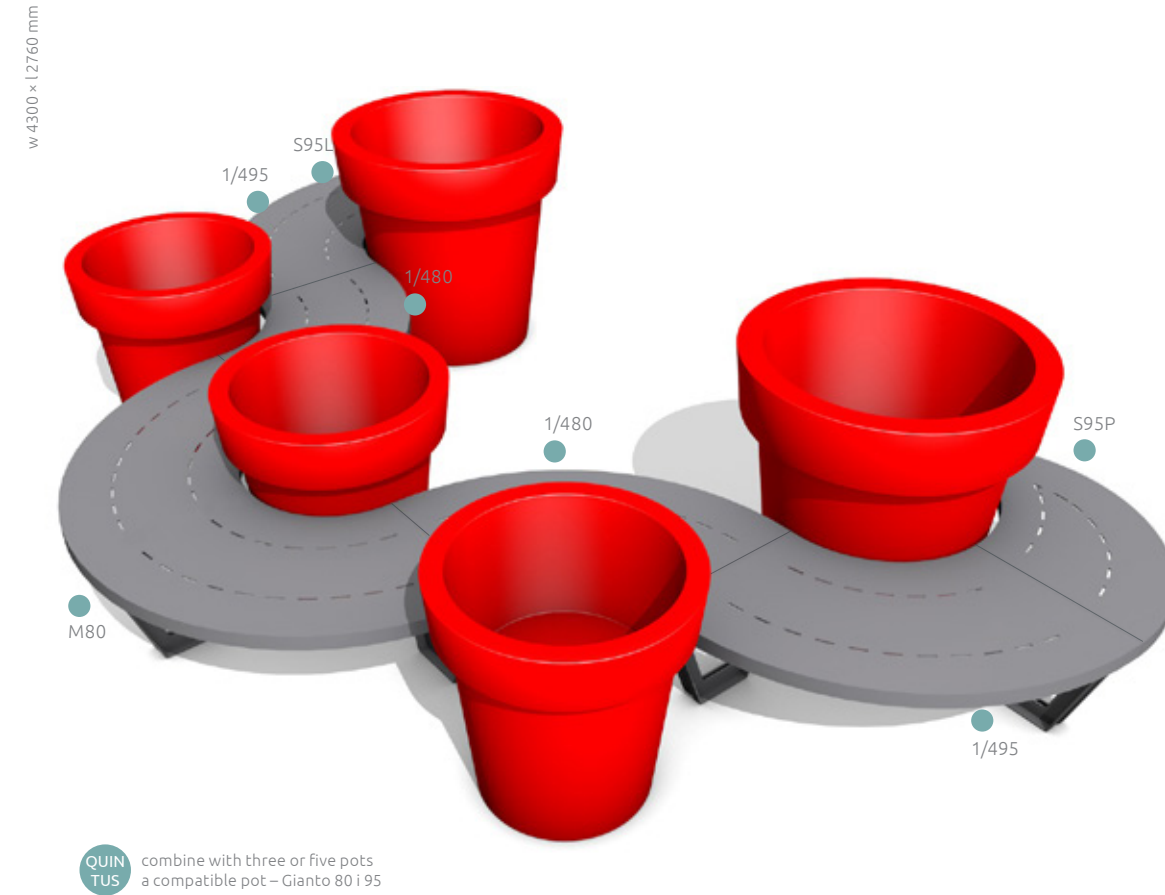

QUINTUS combine with three or five pots a compatible pot – Gianto 80 i 95

view



sketch

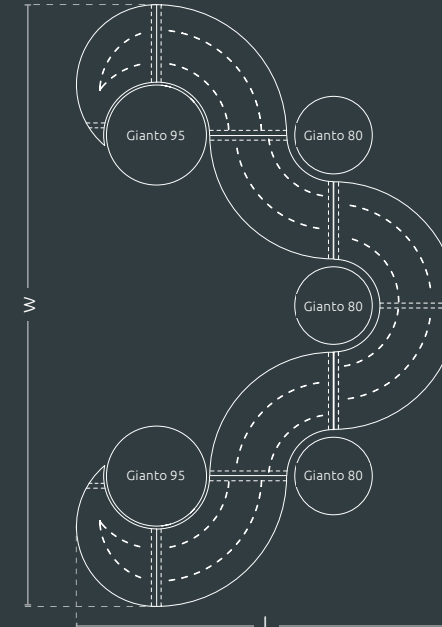



[www.terracity.?](http://www.terracity.)



Terra Group

Alpha Business Center
ul. Wrocławska 17B
65-427 Zielona Góra

T: +48 68 455 62 69
F: +48 68 414 54 25
E: info@terra-uk.eu

www.terra-uk.eu



TerraCity is the TerraGroup Brand.

