



URBAN FURNITURE COLLECTION

URBANA



URBANA

Furniture For Urban Jungle

Classical solutions on an urban scale. The Urbana Collection is a line of modular elements for public spaces. A bench, pot, tourist information stand or bicycle rack can be presented as individual elements, but also they can create a coherent composition in the space or become its main accent. Their high weight means that there is no need of fixing the furniture to the ground and the effect is immediate without any construction works. Steel used in the production process of the Urbana Collection guarantees that the decorations resist severe weather conditions but also acts of vandalism. They are solid, aesthetic and functional solutions for years.



AOK
Gesundheitszentrum

AOK REGION

Einfahrt
Verboten



SIGMARINGEN

RATHAUS



KNAEPPLE
www.knaepple.de
sauber. schnell.



Urban Pot Urbana L

A small flower pot made from steel. This model with the capacity of almost 200 liters provides the possibility of launching significant number of plants into the surroundings, even in the places without any natural substrate. A solid container can go with other elements of the collection.

Features



compatible with the whole collection



powder coating RAL



frame - hot-dip galvanized steel



walls - hot-dip galvanized steel



reinforced bottom



heavy and stable



styrofoam insulation



adjustable height



Waranty 24 months

| Model | Code | Dimensions [mm] | Capacity |
|--------------------|------------|------------------------|----------|
| Urban Pot Urbana L | TC 001 101 | w 1040 × h 700 × d 555 | 176 l |



1 - green



2 - gold



3 - copper



4 - black

antique colors



Personalized Model
(any pot size - according to your needs)

ARE YOU LOOKING FOR A PRODUCT IN A DIFFERENT COLOR? Ask your sales advisor about the details.

Urban Pot Urbana L

w 1040 × h 700 × d 555 mm



front view

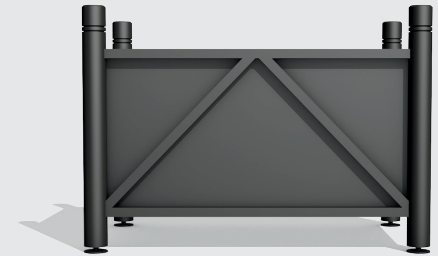

sketch

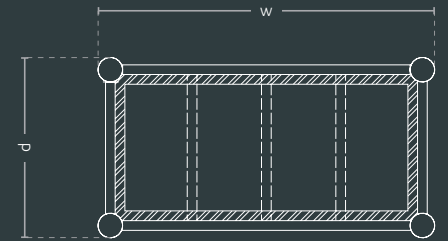

view

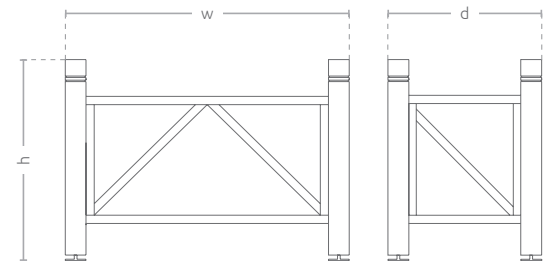

Urban Pot Urbana XL

A big pot made from steel. The largest model with the capacity of almost 700 liters allows to launch the maximum number of plants into the surroundings, even into places without natural substrate. A solid container can go together with other elements of the collection.

OPTIONAL



stabilizing holders to a tree

Features



compatible with the whole collection



powder coating RAL



frame - hot-dip galvanized steel



walls - hot-dip galvanized steel



reinforced bottom



heavy and stable



styrofoam insulation



adjustable height



Waranty 24 months

| Model | Code | Dimensions [mm] | Capacity |
|---------------------|------------|--------------------------|----------|
| Urban Pot Urbana XL | TC 001 102 | w 1040 × h 1145 × d 1040 | 684 l |



1 - green



2 - gold



3 - copper



4 - black

antique colors



Personalized Model
(any pot size - according to your needs)

ARE YOU LOOKING FOR A PRODUCT IN A DIFFERENT COLOR? Ask your sales advisor about the details.

w 1040 x h 1145 x d 1040 mm



Choose color which remains unchanged for years

Powder coating guarantees that a color of the pot will not change under the influence of various weather conditions for long years

front view

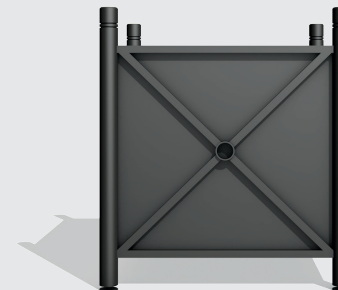

sketch

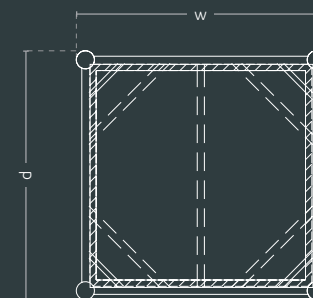

view

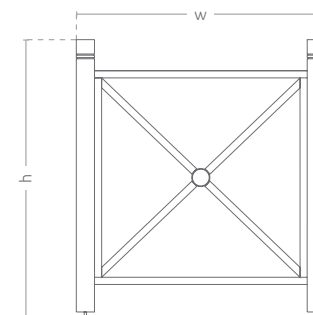

Bicycle Rank Urbana L

The steel bicycle rank is adjusted to the L pot. It was created in response to the growing trend of riding a bike. An additional function of the construction is an information stand with a map. Steel spans guarantee safe storage of the vehicles and resistance to mechanical damage.

Features



compatible with the whole collection



powder coating RAL



frame - hot-dip galvanized steel



walls - hot-dip galvanized steel



reinforced bottom



heavy and stable



styrofoam insulation



adjustable height



Waranty 24 months

| Model | Code | Dimensions [mm] | Capacity |
|-----------------------|------------|----------------------------------|----------|
| Bicycle Rank Urbana L | TC 001 502 | w 1040 × hc 1695 × h 700 × d 855 | 176 l |



1 - green



2 - gold



3 - copper



4 - black

antique colors



Personalized Model
(any pot size - according to your needs)

ARE YOU LOOKING FOR A PRODUCT IN A DIFFERENT COLOR? Ask your sales advisor about the details.

Bicycle Rank Urbana L

w 1040 x hc 1695 x h 700 x d 855 mm

A single decoration or an element of a bigger composition ●



A solid rank can be a single decoration and does not require additional installation or excavation ●

front view

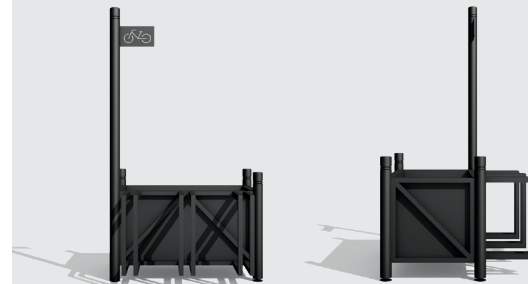

sketch

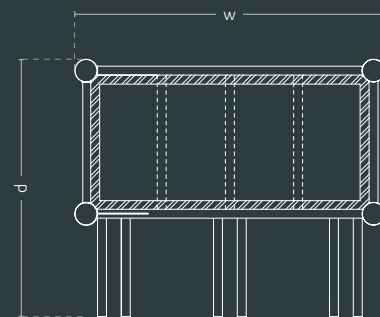

view

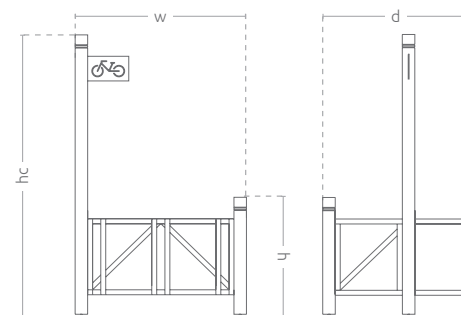

Bicycle Rank Urbana XL

The steel bicycle rank compatible with the XL pot. It was created in response to the growing trend of riding a bike. An additional function of the construction is an information stand with a map. Steel spans guarantee safe storage of the vehicles and resistance to mechanical damage.

OPTIONAL



stabilizing holders to a tree

Features



compatible with the whole collection



powder coating RAL



frame - hot-dip galvanized steel



walls - hot-dip galvanized steel



reinforced bottom



heavy and stable



styrofoam insulation



adjustable height



Waranty 24 months

| Model | Code | Dimensions [mm] | Capacity |
|------------------------|------------|------------------------------------|----------|
| Bicycle Rank Urbana XL | TC 001 501 | w 1040 x hc 1695 x h 1145 x d 1340 | 684 l |



1 - green



2 - gold



3 - copper



4 - black

antique colors



Personalized Model
(any pot size - according to your needs)

ARE YOU LOOKING FOR A PRODUCT IN A DIFFERENT COLOR? Ask your sales advisor about the details.

Bicycle Rank Urbana XL

w 1040 × hc 1695 × h 1145 × d 1340 mm



● Safe storage of bikes

● The wheel holders are made from heavy and stable steel which prevents their theft and damage

front view



sketch

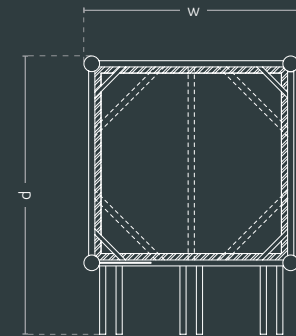

view

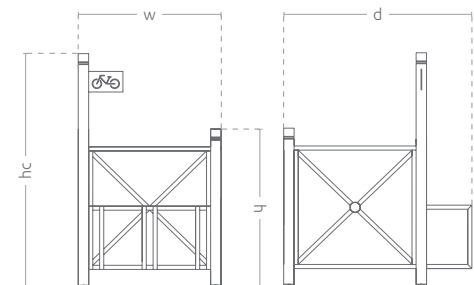

Tourist Information Stand Urbana L

A tourist information stand built on a solid, steel construction. It is an element of the collection thanks to which tourists and guests will be provided with required information: city maps, welcome leaflets or timetables of public transport. The product is compatible with the L pot, which allows to bring some additional plants to the surroundings.

Features



compatible with the whole collection



powder coating RAL



frame - hot-dip galvanized steel



walls - hot-dip galvanized steel



reinforced bottom



heavy and stable



styrofoam insulation



adjustable height



Waranty 24 months

| Model | Code | Dimensions [mm] | Capacity |
|------------------------------------|------------|----------------------------------|----------|
| Tourist Information Stand Urbana L | TC 001 402 | w 1040 × hc 1695 × h 700 × d 550 | 176 l |



1 - green



2 - gold



3 - copper



4 - black

antique colors



Personalized Model
(any pot size - according to your needs)

ARE YOU LOOKING FOR A PRODUCT IN A DIFFERENT COLOR? Ask your sales advisor about the details.

Tourist Information Stand Urbana L

w 1040 x hc 1695 x h 700 x d 550 mm

Add graphic elements of the stand



An information board makes it easy to present consistent visual identification of the surroundings



front view

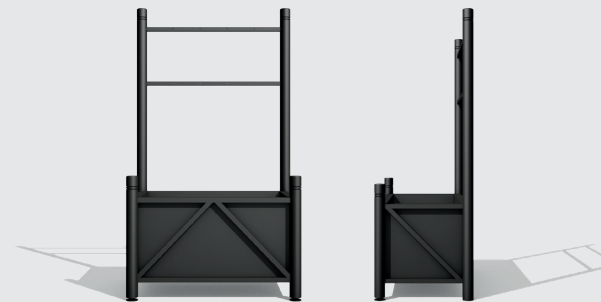

sketch

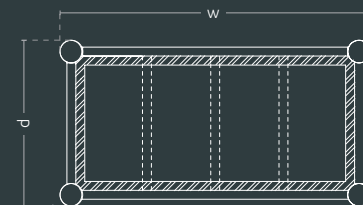

view

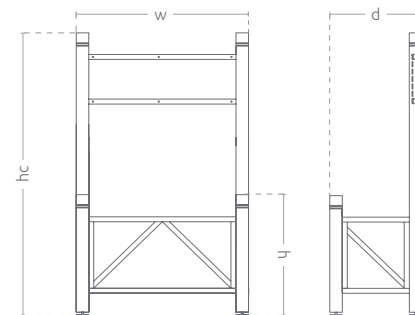

Tourist Information Stand Urbana XL

A tourist information stand built on a solid, steel construction. It is an element of the collection thanks to which tourists and guests will be provided with required information: city maps, welcome leaflets or timetables of public transport. The product is compatible with the XL pot, which allows to bring some additional plants to the surroundings.

OPTIONAL



stabilizing holders to a tree

Features



compatible with the whole collection



powder coating RAL



frame - hot-dip galvanized steel



walls - hot-dip galvanized steel



reinforced bottom



heavy and stable



styrofoam insulation



adjustable height



Waranty 24 months

| Model | Code | Dimensions [mm] | Capacity |
|-------------------------------------|------------|------------------------------------|----------|
| Tourist Information Stand Urbana XL | TC 001 401 | w 1040 × hc 1695 × h 1145 × d 1040 | 684 l |



1 - green



2 - gold



3 - copper



4 - black

antique colors



Personalized Model
(any pot size - according to your needs)

ARE YOU LOOKING FOR A PRODUCT IN A DIFFERENT COLOR? Ask your sales advisor about the details.

w 1040 × hc 1695 × h 1145 × d 1040 mm



Stabilizing brackets for the trees and larger decorative plants allow for efficient implementation of the greenery into the surrounding

front view

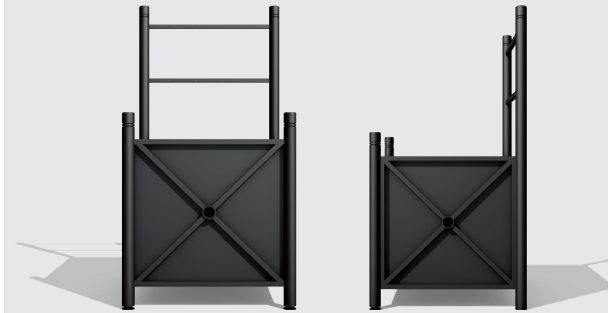

sketch

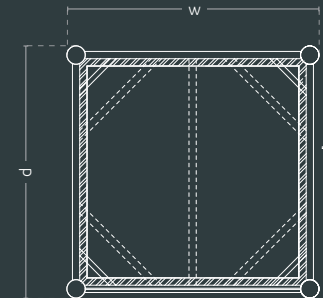

view

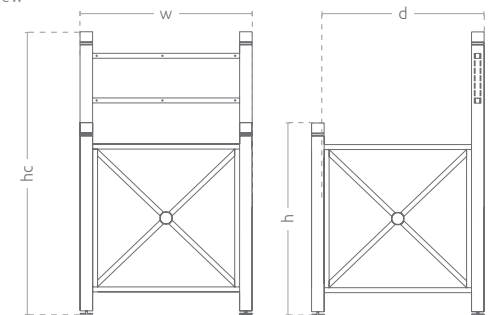



CAMPO
S. ANZOLO
PARROCCHIA
CASSINANO

CAMPO
S. ANZOLO



Urban Pot Urbana 1/4

A steel pot in a 1/4 circle shape. This model allows to create various compositions, not only in corners but also on a circular concept. It provides an opportunity to launch into the surroundings a significant number of plants. The solid container can go with other elements of the collection.

Features



powder coating RAL



frame - hot-dip galvanized steel



walls - hot-dip galvanized steel



reinforced bottom



heavy and stable



styrofoam insulation



adjustable height



Waranty 24 months

| Model | Code | Dimensions [mm] | Capacity |
|----------------------|------------|---|----------|
| Urban Pot Urbana 1/4 | TC 001 103 | wo 1180 × hc 700 × wi 830 × h 590 × d 410 | 176 l |



1 - green



2 - gold



3 - copper



4 - black

antique colors



Personalized Model
(any pot size - according to your needs)

ARE YOU LOOKING FOR A PRODUCT IN A DIFFERENT COLOR? Ask your sales advisor about the details.

w 1040 × hc 1695 × h 1145 × d 1040 mm



Set of pots 1/4

The pot insulated with styrofoam – an insulation layer, which assures optimal conditions for plants

front view



sketch

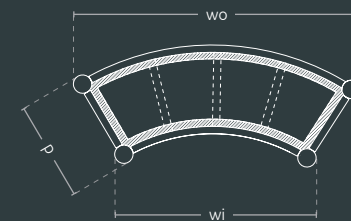

side view

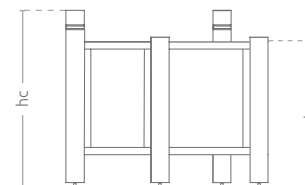

Urban Bench Urbana L

An urban bench based on the steel elements with a seat made of synthetic wood. Steel, hot-dip galvanized legs are stylish but also resistant to the acts of vandalism. A solid seat guarantees comfortable rest.

Features



compatible with the whole collection



powder coating RAL



hot-dip galvanized steel



fixings to the ground



a bench seat made from composite board



Waranty 24 months

| Model | Code | Dimensions [mm] |
|----------------------|------------|-------------------------|
| Urban Bench Urbana L | TC 001 302 | w 1800 × h 450 × ds 430 |



1 - green



2 - gold



3 - copper



4 - black

antique colors



Personalized Model
(any pot size - according to your needs)

ARE YOU LOOKING FOR A PRODUCT IN A DIFFERENT COLOR? Ask your sales advisor about the details.

Urban Bench Urbana L

w 1800 x h 450 x ds 430 mm

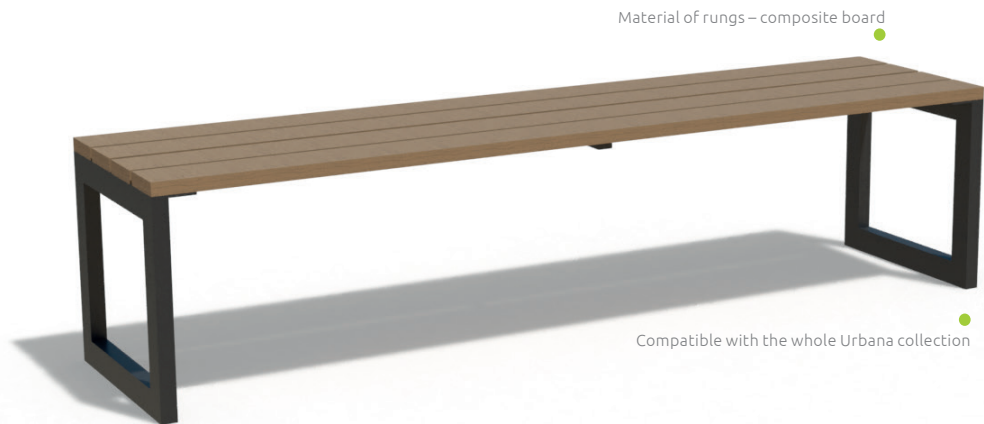

front view



sketch



side view



Urban Bench Urbana XL

An urban bench based on steel elements with a seat made of synthetic wood. Steel galvanized legs are stylish but also resistant to the acts of vandalism. This solid seat guarantees comfortable rest.

Features



compatible with the whole collection



powder coating RAL



hot-dip galvanized steel



fixings to the ground



a bench seat made from composite board



Waranty 24 months

| Model | Code | Dimensions [mm] |
|-----------------------|------------|--|
| Urban Bench Urbana XL | TC 001 301 | w 1800 × h 945 × d 550 × hs 450 × ds 390 |



1 - green



2 - gold



3 - copper



4 - black

antique colors



Personalized Model
(any pot size - according to your needs)

ARE YOU LOOKING FOR A PRODUCT IN A DIFFERENT COLOR? Ask your sales advisor about the details.

Urban Bench Urbana XL

w 1800 x h 945 x d 550 x hs 450 x ds 390 mm

Material of rungs – composite board

Compatible with the whole Urbana collection

front view



sketch

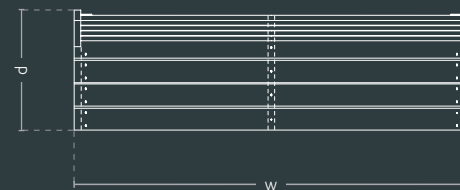

side view

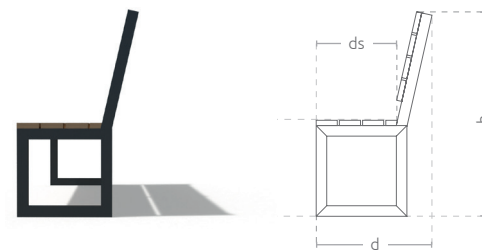

Railing Urbana L

A fully functional large railing, compatible with other urban furniture from the Urbana Collection. It is made from hot-dip galvanized steel, thus it is very durable and resistant to the acts of vandalism as well as changeable weather conditions. The product can be a part of some bigger composition, functioning as a fence, decoration or an element joining pots. The railing cannot remain an individual element without any pot or bench.

Features



compatible with the whole collection



powder coating RAL



hot-dip galvanized steel



Waranty 24 months

| Model | Code | Dimensions [mm] |
|------------------|------------|------------------------|
| Railing Urbana L | TC 001 201 | w 1400 × h 1145 × d 72 |



1 - green



2 - gold



3 - copper



4 - black

antique colors



Personalized Model
(any pot size - according to your needs)

ARE YOU LOOKING FOR A PRODUCT IN A DIFFERENT COLOR? Ask your sales advisor about the details.

Railing Urbana L

w 1400 × h 1145 × d 72 mm



front view

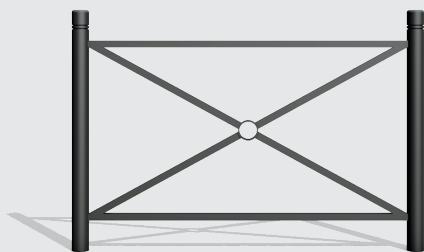

front view

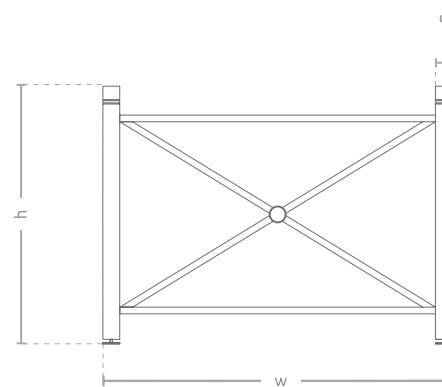

Railing Urbana XL

A fully functional large railing, compatible with other urban furniture from the Urbana Collection. It is made from hot-dip galvanized steel, thus it is very durable and resistant to the acts of vandalism as well as changeable weather conditions. The product can be a part of some bigger composition, functioning as a fence, decoration or an element joining pots. The railing cannot remain an individual element without any pot or bench.

Features



compatible with the whole collection



powder coating RAL



hot-dip galvanized steel



Waranty 24 months

| Model | Code | Dimensions [mm] |
|-------------------|------------|------------------------|
| Railing Urbana XL | TC 001 202 | w 2800 × h 1145 × d 72 |



1 - green



2 - gold



3 - copper



4 - black

antique colors



Personalized Model
(any pot size - according to your needs)

ARE YOU LOOKING FOR A PRODUCT IN A DIFFERENT COLOR? Ask your sales advisor about the details.

Railing Urbana XL

w 2800 × h 1145 × d 72 mm

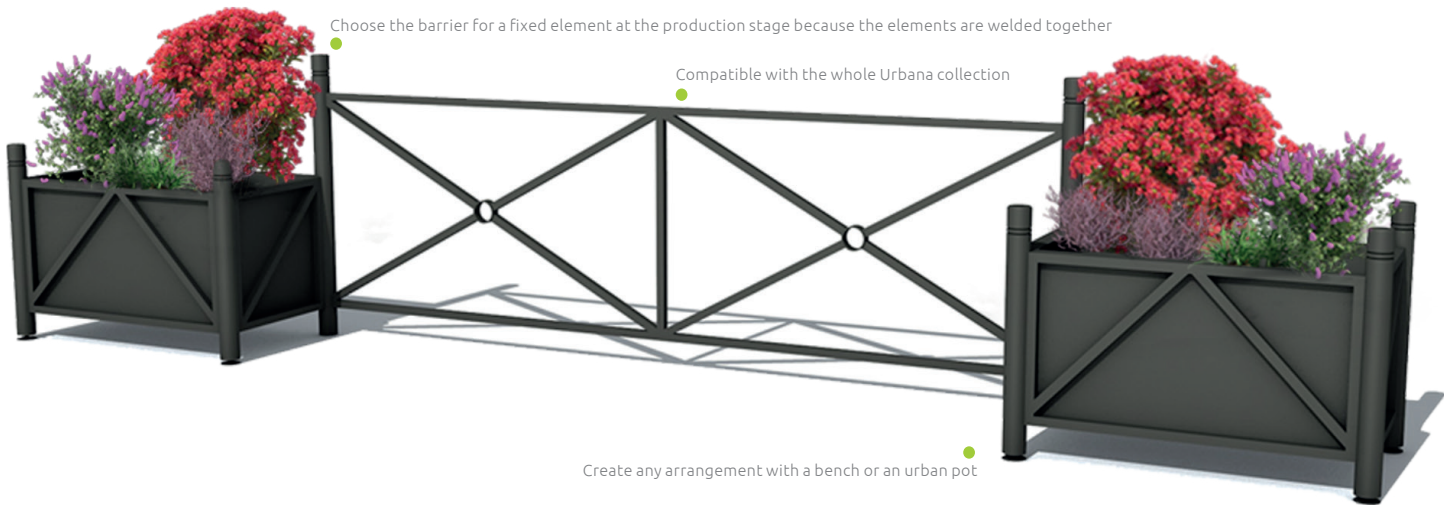

front view

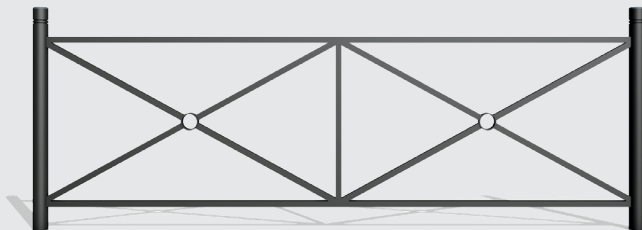

front view

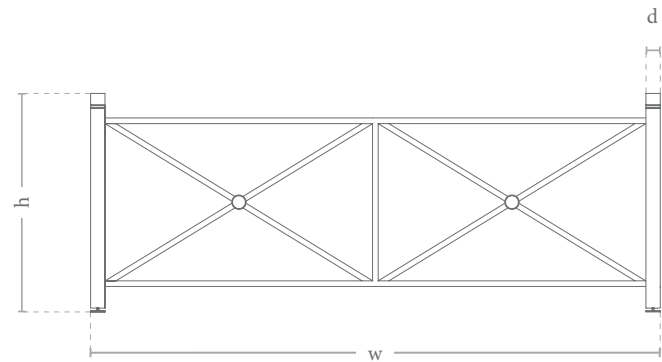



combine any elements

+

**CREATE
YOUR
ARRANGEMENT**

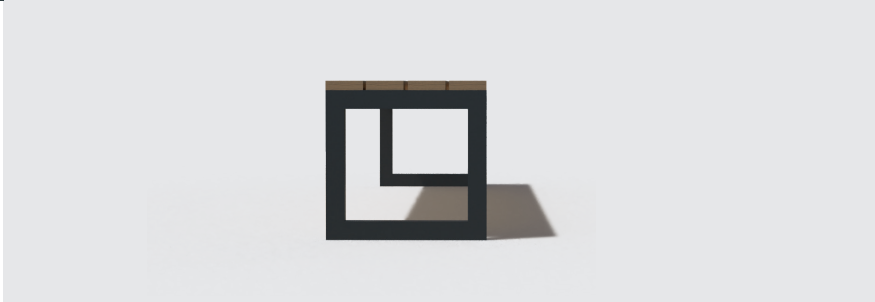
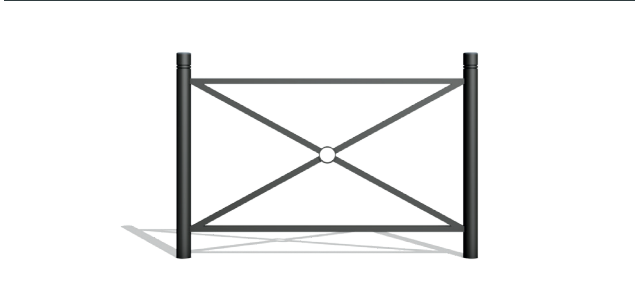

we suggest several options

the length of the set: approx. 5300 mm / the width of the set: approx. 1040 mm

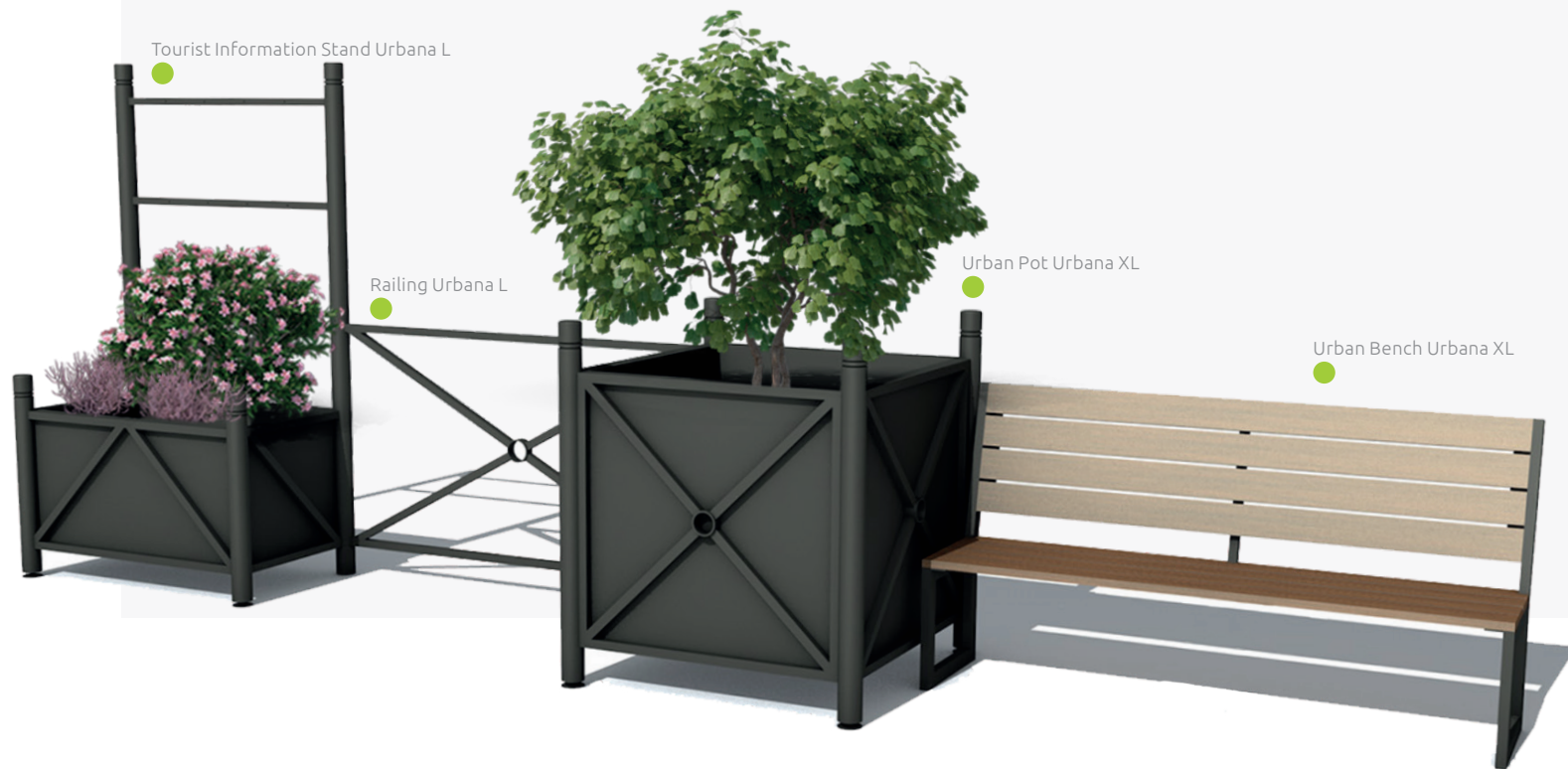

collection

the length of the set approx. 2300 mm / the width of the set approx. 1470 mm



the length of the set approx. 5180 mm / the width of the set approx. 1040 mm



collection









Winiarnia Bacchus
RESTAURACJA

Winiarnia Bacchus
RESTAURACJA

Winiarnia
Bacchus
RESTAURACJA

illego

Available colours

Antique colors

ARE YOU LOOKING FOR A PRODUCT IN A DIFFERENT COLOR?
Ask your sales advisor about the details.

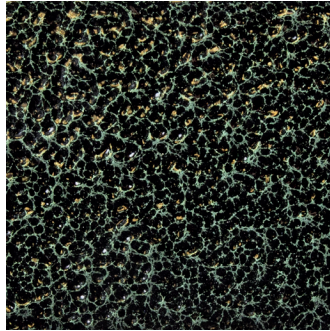

1 - GREEN

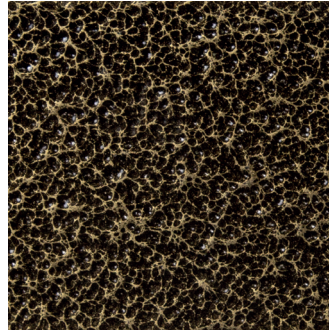

2 - GOLD

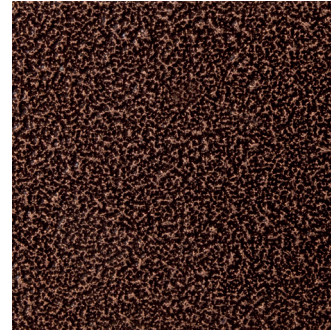

3 - COPPER

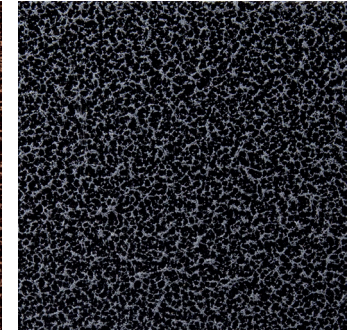

4 - BLACK

COLOURS

Colors RAL

ARE YOU LOOKING FOR A PRODUCT IN A DIFFERENT COLOR?
Ask your sales advisor about the details.

RAL VIVID COLOURS



RAL 7001*
Silver Grey



RAL 1004
Golden Yellow



RAL 2000
Yellow Orange



RAL 4006
Traffic Purple



RAL 5012
Light Blue

RAL FADING COLOURS



RAL 7001*
Silver Grey

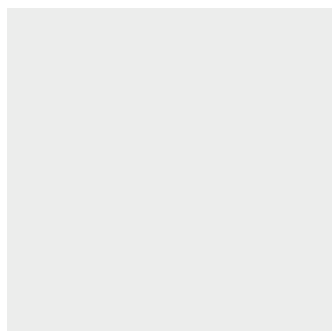

RAL 9016
Traffic White



RAL 6034
Pastel Turquoise



RAL 5008
Gray Blue



RAL 1015
Light Ivory

*RAL 7001 - the constant colour of the rack with supporting feet and the first ring

Contact

We will be happy to answer all your questions.

T: +48 68 455 62 69

E: info@terra-uk.eu

Terra Group
ul. Sowińskiego 42a
65-419 Zielona Góra

www.terracity.eu

Urban furniture collection



Terra[®]
Group



TerraCity - a brand of Terra Group

Terra Group

*Razem stworzymy
piękniejsze jutro!*

ul. Gen. Józefa Sowińskiego 42a
65-419 Zielona Góra

T: +48 68 455 62 69

F.: +48 68 414 54 25

www.terra-uk.eu

www.terracity.eu