

W600/3

Hanging Flower Tower

Specification

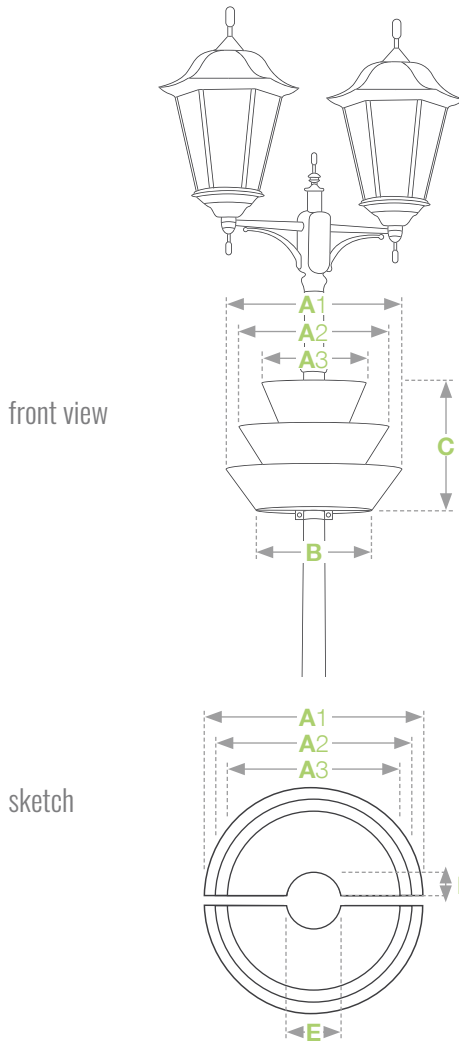







! BEWARE OF IMITATIONS!

It is impossible to copy quality and safety. Only branded products with the sign of Terra can provide the highest quality, safety and accuracy of workmanship.

 Made in Europe

 36 month warranty

- A1** Upper diameter of 1st level ▶ 600 mm
- A2** Upper diameter of 2nd level ▶ 500 mm
- A3** Upper diameter of 3rd level ▶ 400 mm
- B** Bottom diameter ▶ 400 mm
- C** Total height ▶ 475 mm
- D** Inner radius ▶ 60 mm
- E** Inner diameter ▶ 120 mm

-  Number of rings ▶ 3
-  Capacity of substrate ▶ 2 x 31 l
-  Second bottom capacity ▶ 2 x 4 l
-  Weight before planting ▶ 2 x 9 kg
-  Weight of the planting ▶ 2 x 22-45 kg 
-  Estimated amount of seedlings ▶ 2 x 10-14 items

 Weight depends on the type of soil and its moisture

Terra Flower Tower construction is under a 3-year warranty program called „DOOR TO DOOR“. In fact, it is an extensive system of support and technical assistance, as well as an extremely efficient service guarantee. When a fault is detected in our products, service team fix it wherever you want or exchange the product with a new one.

Production method

- laser-cut rings
- MAG/TIG welded rings
- hot dip galvanized
- powder coated rings (DUPLEX system)

Colours

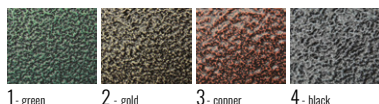

DUPLEX System

The combination of a galvanized layer and a polyester powder coat gives an extraordinary resistance. The top coat of paint, which supposed to be a decoration, becomes an additional anticorrosive layer.

Safety

- rubber seals on each ring
- no sharp edges
- high weight and stability
- high resistance to vandalism
- fixing to the ground (optional)

Assembly system

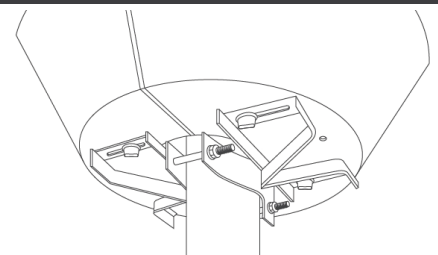

W600/3

Hanging Flower Tower

Transport

side view

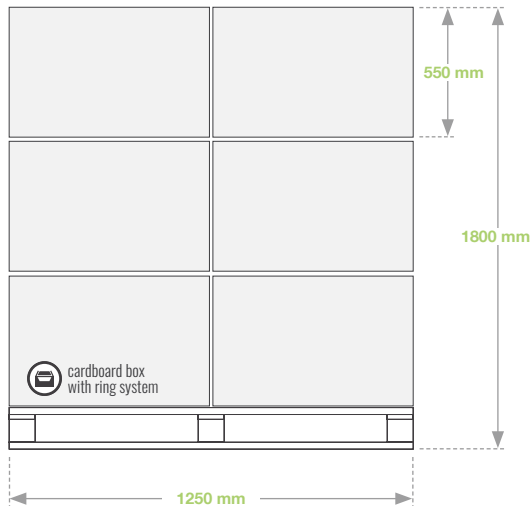

front view

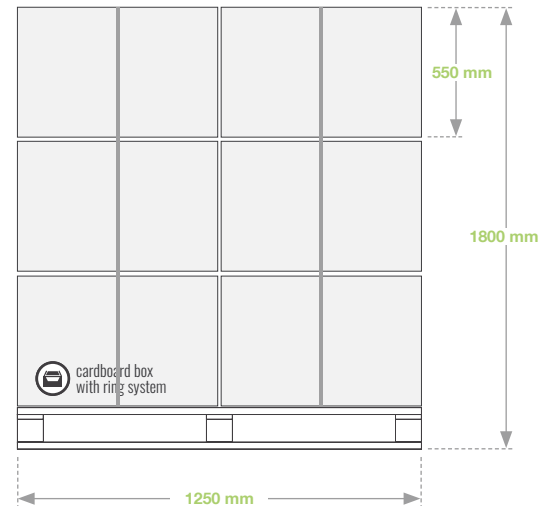

 SET PACKED IN A CARDBOARD BOX  UP TO 12 SETS ON A PALLET

Set contents

bottom fixing **A** (below 59 mm)
B (60 - 89 mm)

A rubber gasket	5 m
Fixing	1 kpl.
Screw 10 x 50	4 pcs
Wing screw 8 x 20	4 pcs

bottom fixing **C** (90 - 120 mm)

A rubber gasket	5 m
Fixing	1 kpl.
Screw 10 x 70	4 pcs
Wing screw 8 x 20	4 pcs

bottom fixing **D** (above 120 mm)

A rubber gasket	5 m
Fixing	1 kpl.
Screw 10 x 90	4 pcs
Wing screw 8 x 20	4 pcs

Additional Accessories

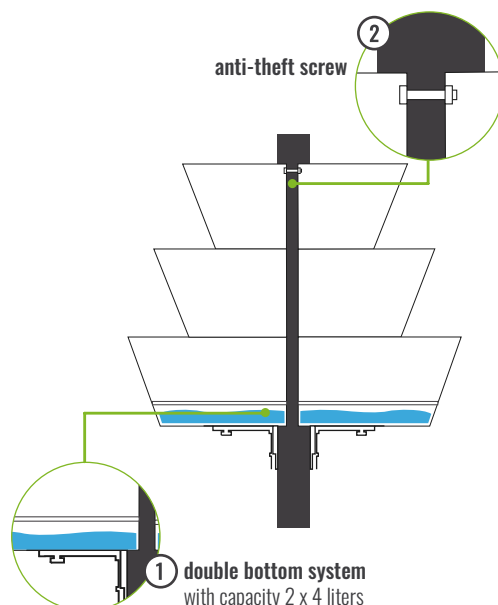

TerraClick Tif

System montażowy

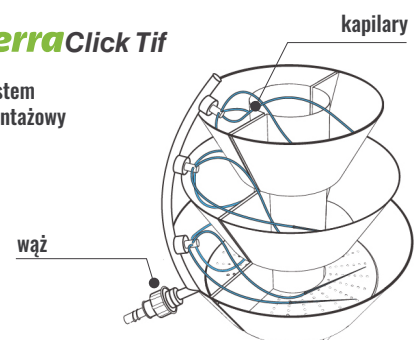

line number in the system
type of connectors
nominal flow of drippers
working pressure
anti-drip opening pressure
anti-drip closing pressure
hose type

- ▶ 3 verticals x 4 capillaries
- ▶ PP
- ▶ 2 - 4 l/h
- ▶ 0,5 - 4 atm
- ▶ 0,4 atm
- ▶ 0,2 atm
- ▶ new generation resistant to chemicals and acidification