

# W800/1

# Hanging Flower Tower

## Specification

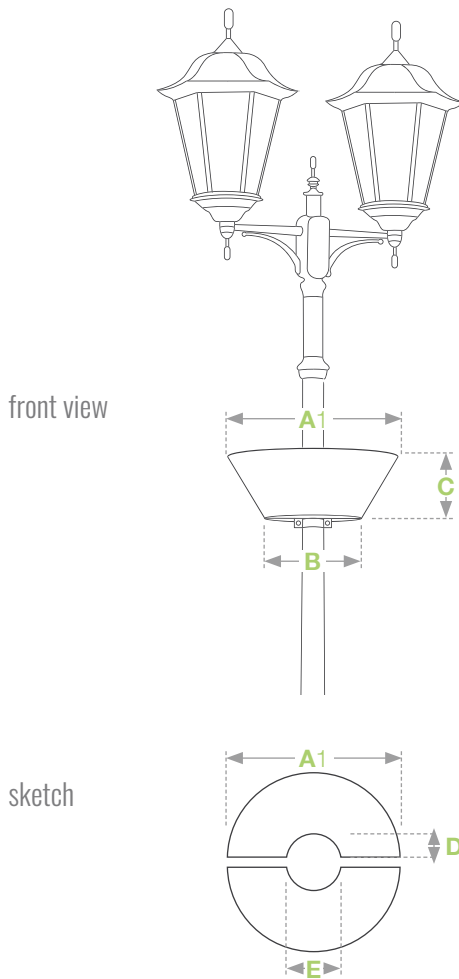







### ! BEWARE OF IMITATIONS!

It is impossible to copy quality and safety. Only branded products with the sign of Terra can provide the highest quality, safety and accuracy of workmanship.

 Made in Europe

 24 month warranty

<b>A1</b>	Upper diameter	▶	<b>800 mm</b>
<b>B</b>	Bottom diameter	▶	<b>490 mm</b>
<b>C</b>	Total height	▶	<b>270 mm</b>
<b>D</b>	Inner radius	▶	<b>60 mm</b>
<b>E</b>	Inner diameter	▶	<b>120 mm</b>

	Number of rings	▶	<b>1</b>
	Capacity of substrate	▶	<b>2 x 32 l</b>
	Second bottom capacity	▶	<b>2 x 5,5 l</b>
	Weight before planting	▶	<b>2 x 11 kg</b>
	Weight of the planting	▶	<b>2 x 18-42 kg</b> 
	Estimated amount of seedlings	▶	<b>2 x 8-10 items</b>

 Weight depends on the type of soil and its moisture

### ? OPTIONAL - CULTIVATION INSERT CULTURE TUB

Ask your sales advisor about the details

**Terra Flower Tower construction is under a 2-year warranty program called „DOOR TO DOOR“.** In fact, it is an extensive system of support and technical assistance, as well as an extremely efficient service guarantee. When a fault is detected in our products, service team fix it wherever you want or exchange the product with a new one.

## Production method

laser-cut rings

MAG/TIG welded rings

hot dip galvanized

## Optional

powder coated rings (DUPLEX system)

## Colours

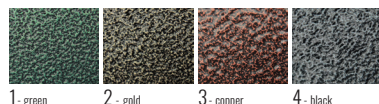

### DUPLEX System

The combination of a galvanized layer and a polyester powder coat gives an extraordinary resistance. The top coat of paint, which supposed to be a decoration, becomes an additional anticorrosive layer.

## Safety

rubber seals on each ring

no sharp edges

high weight and stability

high resistance to vandalism

fixing to the ground (optional)

### Assembly system

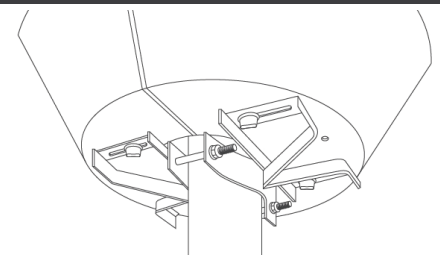

W800/1

# Hanging Flower Tower

## Transport

side view

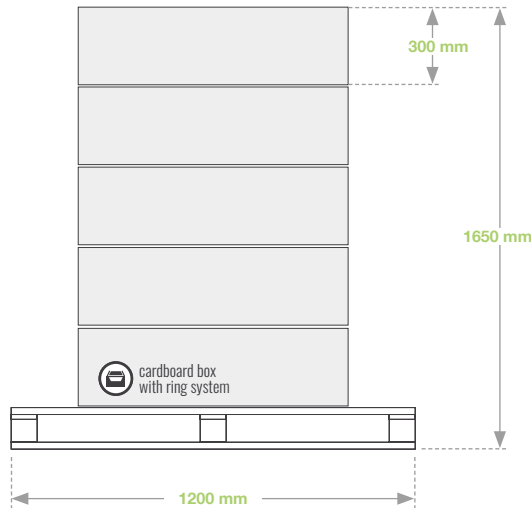

front view

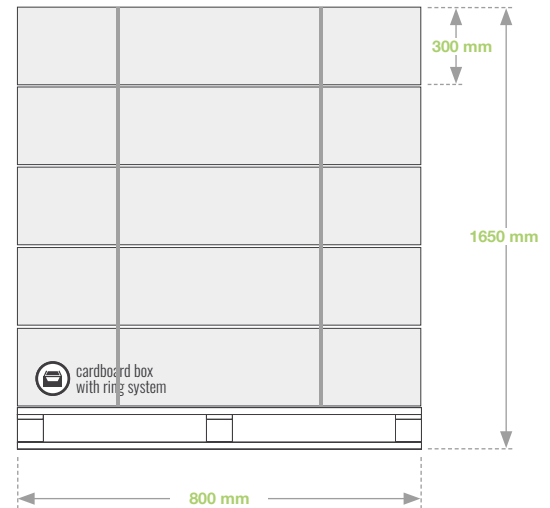

 SET PACKED IN A CARDBOARD BOX    
  UP TO 5 SETS ON A PALLET

## Set contents

**bottom fixing** **A** (below 59 mm)  
**B** (60 - 89 mm)

A rubber gasket	2,5 m
Fixing	1 kpl.
Screw 10 x 50	4 pcs
Wing screw 8 x 20	4 pcs

**bottom fixing** **C** (90 - 120 mm)

A rubber gasket	2,5 m
Fixing	1 kpl.
Screw 10 x 70	4 pcs
Wing screw 8 x 20	4 pcs

**bottom fixing** **D** (above 120 mm)

A rubber gasket	2,5 m
Fixing	1 kpl.
Screw 10 x 90	4 pcs
Wing screw 8 x 20	4 pcs

## Additional Accessories

- 1** double bottom system with capacity 2 x 4 liters
- 2** anti-theft screw
- 3** Culture Tub cultivation insert

It is a special plant container, which makes it possible to change plantings without disassembling the decoration - fast and without any complicated works.

